

GRUPPOLUBE



SOTTOPENSILE
MOOVE-S

2024

GRUPPO **LUBE**

"Moove-S" è uno schienale attrezzato per la cucina, composto da un pannello e da profili di alluminio disegnati per agganciare gli accessori da cucina e fungere da alzatina. Il profilo superiore, inoltre, può essere dotato anche di illuminazione LED integrata.

Progettato per ottimizzare lo spazio compreso tra i pensili e il piano lavoro della cucina, "Moove-S" combina funzionalità ed estetica ed unisce in un'unica soluzione un sistema sottopensile, l'alzatina salvagoccia e l'illuminazione LED.

"Moove-S" è una soluzione completamente personalizzabile, i profili sono realizzati su misura e con un'ampia varietà di finiture ed accessori, può svilupparsi lineare oppure ad angolo mentre il pannello può essere scelto tra una vasta selezione di decorativi del "Gruppo LUBE".

"Moove-S" is an equipped backsplash for the kitchen, consisting of a panel and profiles made of aluminum designed to attach kitchen accessories and act as a splashback. The profile top can also be equipped with integrated LED lighting.

Designed to optimize the space between the wall cabinets and the kitchen countertop, "Moove-S" combines functionality and aesthetics and combines an undercounter system, drip saver splashback and LED lighting in a single solution.

"Moove-S" is a fully customizable solution, the profiles made to measure and with a wide variety of finishes and accessories, it can develop linear or corner while the panel can be chosen from a wide selection of decors from the range "LUBE Group."



Schienale attrezzato "Moove-S" "Moove-S" equipped backslash

La versione lineare è comprensiva di pannelli (tipologie riportati a partire da pag.16) , profilo superiore e profilo inferiore, profili di chiusura laterali e relativa ferramenta montaggio. La lunghezza massima dei profili è di 300 cm.

Eventuali allunghi vanno gestiti con l'aggiunta di un ulteriore profilo e della "giunzione centrale" (vedi pag.5).

La lunghezza massima dei pannelli varia invece a seconda delle finiture (vedi pag.16-22)

Eventuali allunghi vanno gestiti con l'aggiunta di un ulteriore pannello e della "giunzione di interruzione" (vedi pag.5).

The linear version includes panels (types shown starting from page 16), upper profile and lower profile, side closing profiles and relative assembly hardware. The maximum length of the profiles is 300 cm.

Any extensions must be managed with the addition of an additional profile and the "central joint" (see page 5).

The maximum length of the panels varies depending on the finishes (see page 16-22)

Any extensions must be managed with the addition of an additional panel and the "interruption joint" (see page 5).

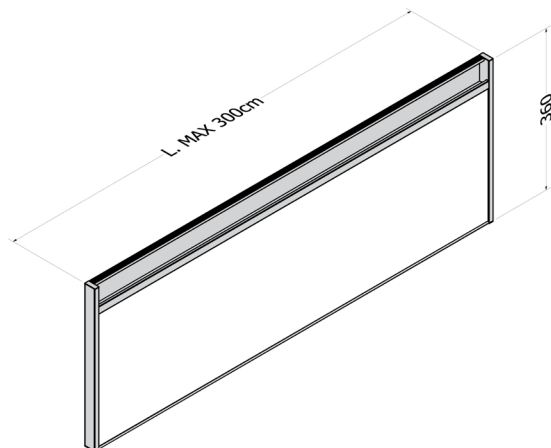

ELEMENTO LINEARE H 36 SENZA LUCE

(Profilo di chiusura superiore + profilo di chiusura inferiore)

LINEAR ELEMENT H 36 WITHOUT LIGHT

(Upper closing profile + lower closing profile)

al ml per lm

Maggiorazione chiusura laterale cad.

Side closure increase each

Maggiorazione profilo angolare 90° cad.

Increase in angular profile 90° each

Kit spessori per schienale sp.10/12 mm

(6 pezzi) inserire tassativamente 1 kit al metro

Backrest shim kit 10/12 mm thick

(6 pieces) insert 1 kit per meter

CODICE
Code

0860MVS01

0860MVP20

N.B. i prezzi non sono comprensivi dei pannelli. Per il prezzo, in base al materiale, vedere il costo al mq nelle pagine 16-22, listino top in composito o listino top in laminato e fenix

Note: the prices do not include the panels. For the price, based on the material, see the cost per square meter in the price list pages 16-22, list of composite tops or list of laminate and fenix tops

La versione lineare con LED è comprensiva di pannelli (tipologie riportati a partire da pag.16) , profilo superiore e profilo inferiore, profili di chiusura laterali con fori per passaggio cavi, ferramenta di montaggio e LED "Linea_8 mm" dual-color.

La lunghezza massima dei profili e del LED è di 300 cm.

Eventuali allunghi vanno gestiti con l'aggiunta di un ulteriore profilo e della "giunzione centrale" (vedi pag.5).

La lunghezza massima dei pannelli varia invece a seconda delle finiture (vedi pag.16-22)

Eventuali allunghi vanno gestiti con l'aggiunta di un ulteriore pannello e della "giunzione di interruzione" (vedi pag.5).

Kit di alimentazione escluso, da inserire obbligatoriamente (vedi pag.12). Per assorbimenti (vedi pag.7).

Per i tipi di accensione vedi (vedi pag.12/14).

The linear version with LED includes panels (types shown starting from page 16), upper profile and lower profile, side closing profiles with holes for cable passage, assembly hardware and dual-color "Linea_8 mm" LED.

The maximum length of the profiles and LED is 300 cm.

Any extensions must be managed with the addition of an additional profile and the "central junction" (see page 5).

The maximum length of the panels varies depending on the finishes (see page 16-22)

Any extensions must be managed with the addition of an additional panel and the "interruption junction" (see page 5).

Power supply kit excluded, must be inserted (see page 12). For absorptions (see page 7).

For types of ignition see (see pages 12/14).

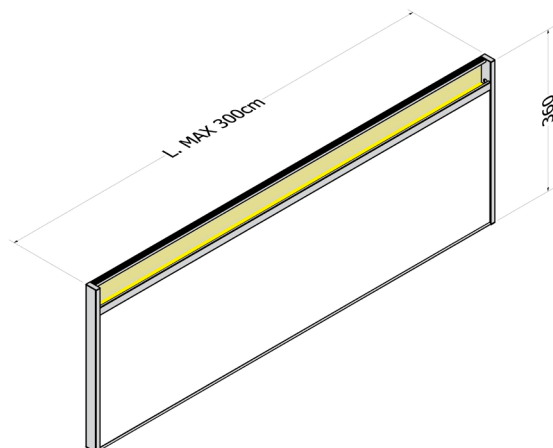

ELEMENTO LINEARE H 36 CON LUCE

(Profilo di chiusura superiore + profilo di chiusura inferiore)

LINEAR ELEMENT H 36 WITH LIGHT

(Upper closing profile + lower closing profile)

al ml per lm

Maggiorazione chiusura laterale cad. (foro led)

Side closure increase each (led hole)

Maggiorazione profilo angolare cad.

Increase in angular profile each

Kit spessori per schienale sp.10/12 mm

(6 pezzi) inserire tassativamente 1 kit al metro

Backrest shim kit 10/12 mm thick

(6 pieces) insert 1 kit per meter

CODICE
Code

0860MVS01

0860MVP20

N.B. i prezzi non sono comprensivi dei pannelli. Per il prezzo, in base al materiale, vedere il costo al mq nelle pagine 16-22, listino top in composito o listino top in laminato e fenix

Note: the prices do not include the panels. For the price, based on the material, see the cost per square meter in the price list pages 16-22, list of composite tops or list of laminate and fenix tops

Giunzioni per schienale attrezzato “Moove-S” “Moove-S” equipped backslash junctions

La giunzione di chiusura centrale va utilizzato raggiunta la lunghezza massima dei profili superiori ed inferiori pari a 300 cm.
Con l'utilizzo del profilo di chiusura centrale vengono interrotti sia i profili superiori ed inferiori, sia il pannello sia il LED.
The central closing junction must be used once the maximum length of the upper and lower profiles equal to 300 cm has been reached.
With the use of the central closing profile, both the upper and lower profiles, the panel and the LED are interrupted.

GIUNZIONE DI CHIUSURA CENTRALE CENTRAL LOCKING JUNCTIONS

	CODICE Code
Giunzione centrale per composizione senza led Central junction for composition without led	0860MVP10
Giunzione centrale per composizione con led Central junction for composition with led	0860MVP15

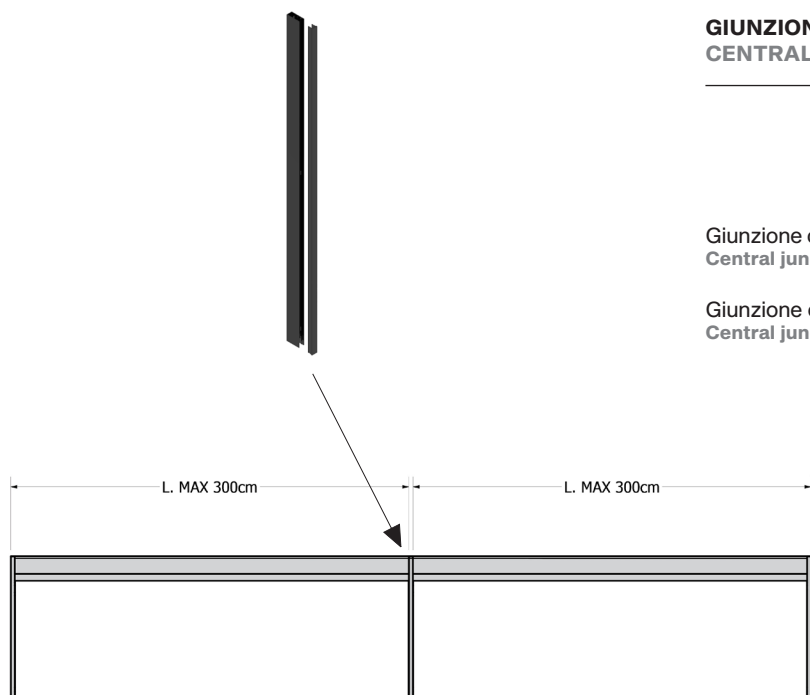

La giunzione di interruzione va utilizzato ogni volta che un pannello, per raggiungimento della sua lunghezza massima o per finalità estetiche, viene interrotto. Il profilo di interruzione lascia ininterrotti il profilo superiore ed inferiore e i LED fino alla loro lunghezza massima di 300 cm.
The interruption junction must be used every time a panel, to reach its maximum length or for aesthetic purposes, is interrupted. The interruption profile leaves the upper and lower profiles and the LEDs uninterrupted up to their maximum length of 300 cm.

GIUNZIONE DI INTERRUZIONE INTERRUPTION JUNCTIONS

	CODICE Code
Giunzione di interruzione per pannelli Interruption junction for panels	0860MVP16

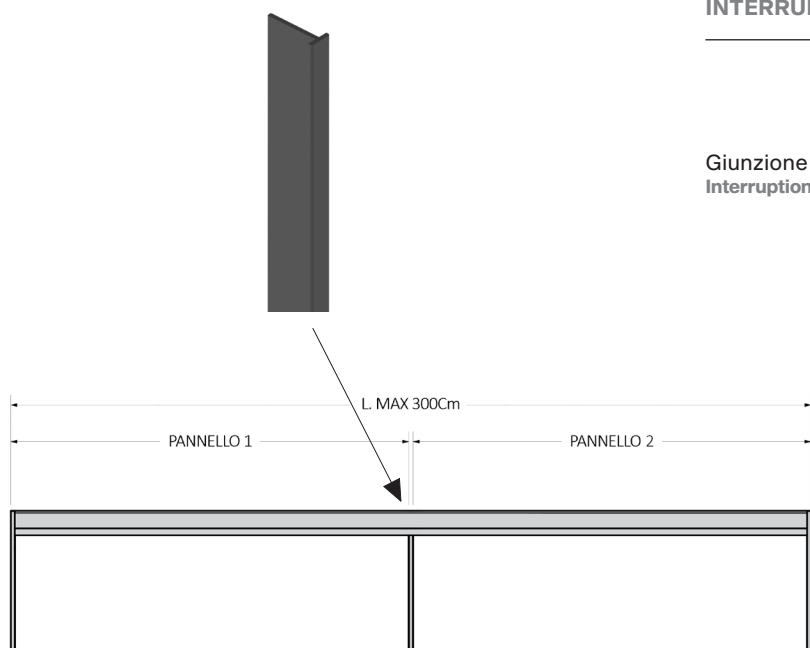

Tipologia montaggio

Type of assembly

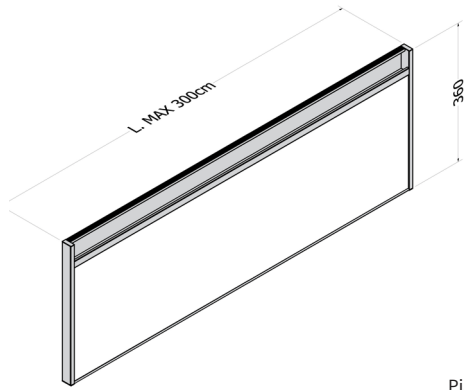

COMPOSIZIONE LINEARE

LINEAR COMPOSITION

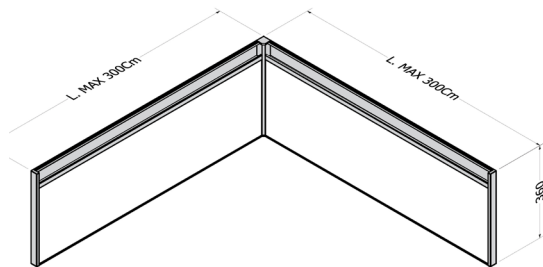
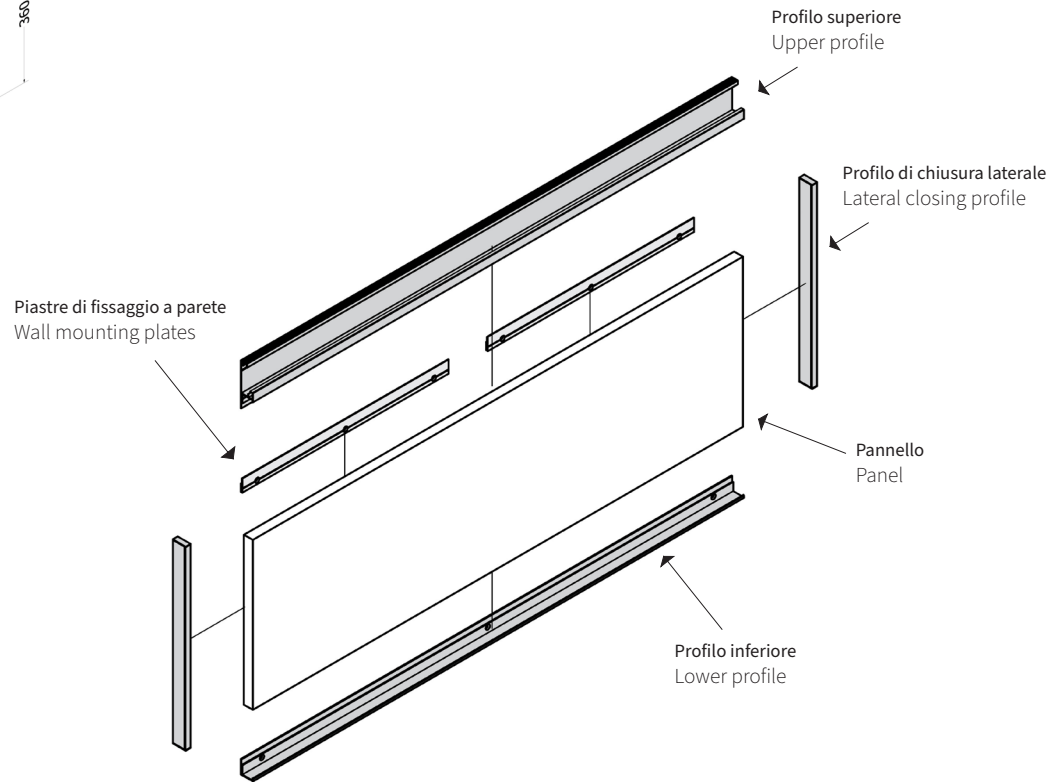

COMPOSIZIONE ANGOLO

ANGULAR COMPOSITION

Il profilo di raccordo angolare è sempre realizzato a 90°.
Eventuali fuori-squadri non possono essere gestiti.
The corner connection profile is always made at 90°.
Any out-of-squares cannot be managed.

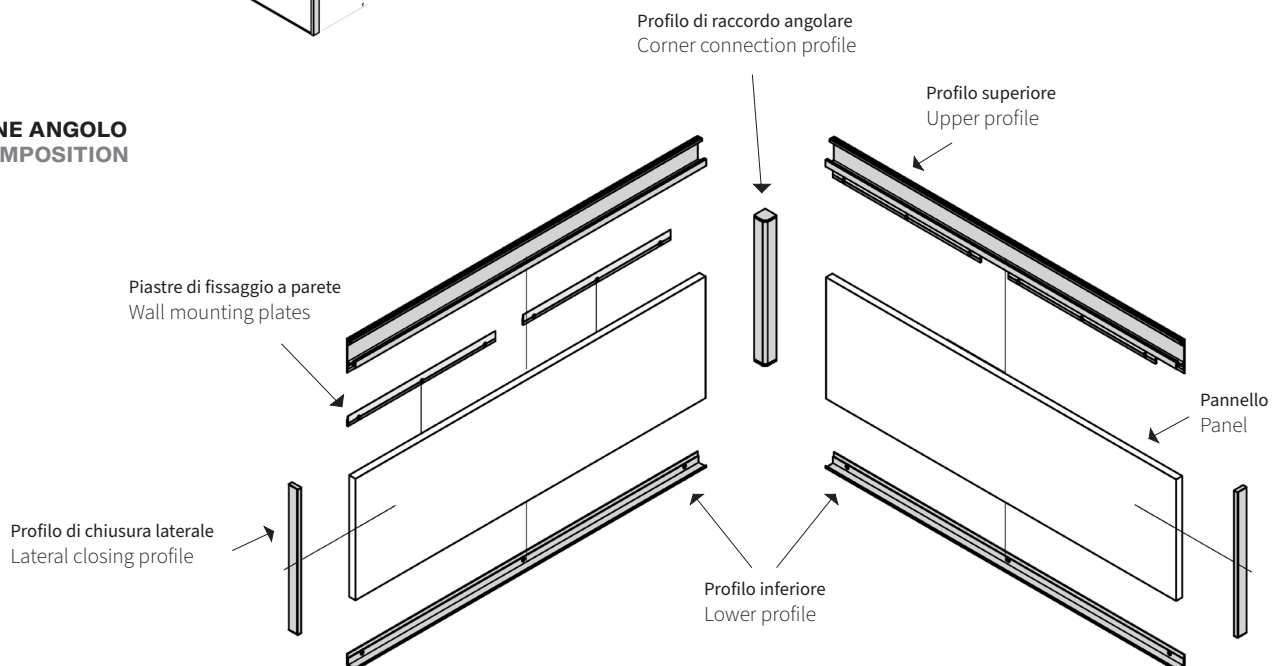

Caratteristiche Luci Features Lights

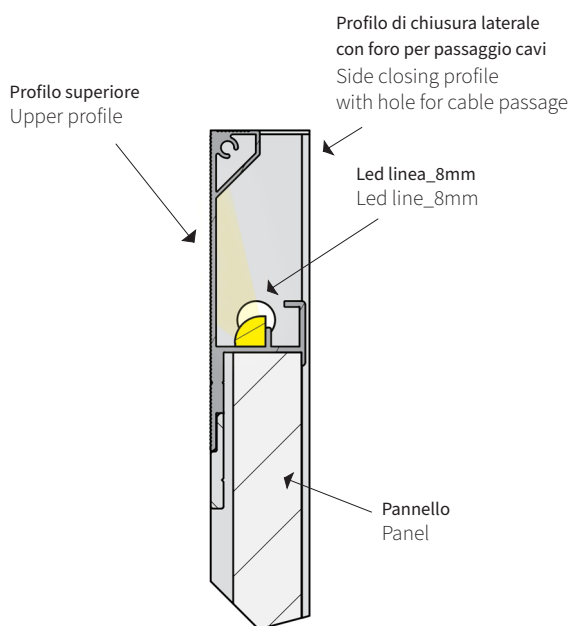

LINEA_8 MM IP20 24V DUAL COLOR

11,5 W al ml 3000-4000K

TIPI DI ACCENSIONE POWER SWITCH ON TYPES

Alimentazione basilare/Connessione diretta
(Vedi pag14)
Simple power supply/Direct connection
(See page 14)

Accensione con telecomando (1 zona)
(Vedi pag.15)
Switch on with remote control (1 area)
(See page 15)

Accensione con app "BlueSmart" o telecomando (4 zone)
(Vedi pag.16)
Switch on with "BlueSmart" app or remote control (4 areas)
(See page 16)

FINITURE PROFILI PROFILE FINISHES



nero black



titanio titanium





silver dark dark silver



umber umber

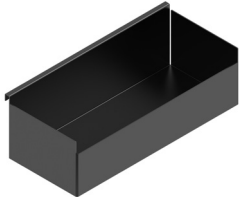
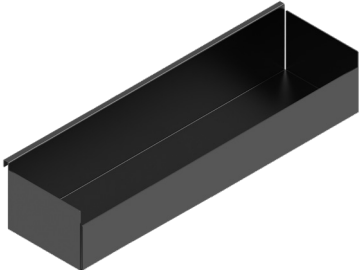

ACCESSORI "MOOVE-S"

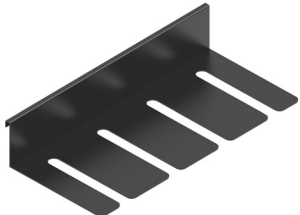
"MOOVE-S" ACCESSORIES

<p>Contenitore in metallo Metal container</p>  <p style="text-align: right;">L 30 P 13,8 H 10 cad W 30 D 13,8 H 10 each</p>	<p>CODICE / CODE No.</p> <p style="text-align: center;">0860MVA01</p>	
<p>Contenitore in metallo Metal container</p>  <p style="text-align: right;">L 55 P 13,8 H 10 cad W 55 D 13,8 H 10 each</p>	<p style="text-align: center;">0860MVA03</p>	
<p>Portarotolo in metallo Metal roll holder</p>  <p style="text-align: right;">L 30 P 14,8 H 7,5 cad W 30 D 14,8 H 7,5 each</p>	<p style="text-align: center;">0860MVA10</p>	
<p>Porta 4 calici 4 glasses rack</p>  <p style="text-align: right;">L 39,5 P 18,5 H 7,5 cad W 39,5 D 18,5 H 7,5 each</p>	<p style="text-align: center;">0860MVA11</p>	

ACCESSORI "MOOVE-S"

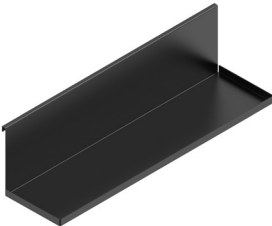
"MOOVE-S" ACCESSORIES

<p>Mensola in metallo Metal shelf</p>  <p>L 30 P 13,8 H 1,5 cad W 30 D 13,8 H 1,5 each</p>	<p>CODICE / CODE No.</p> <p>0860MVA20</p>	
<p>Mensola in metallo Metal shelf</p>  <p>L 50 P 13,8 H 13,6 cad W 50 D 13,8 H 13,6 each</p>	<p>0860MVA25</p>	
<p>Set di 3 ganci Set of 3 hooks</p>  <p>L 0,6 P 1,8 H 2,8 cad W 0,6 D 1,8 H 2,8 each</p>	<p>0860MVA05</p>	
<p>Set di 2 ganci con foro Set of 2 hooks with hole</p>  <p>L 2,1 P 1,8 H 2,8 cad W 2,1 D 1,8 H 2,8 each</p>	<p>0860MVA06</p>	

ACCESSORI "MOOVE-S"

"MOOVE-S" ACCESSORIES

Portacoltelli in faggio
Beech knife holder



L 25 P 4,2 H 29,5 cad
W 25 D 4,2 H 29,5 each

CODICE / CODE No.

0860MVA15

Tagliere in faggio
Beech chopping board



L 40 P 3 H 29,5 cad
W 40 D 3 H 29,5 each

0860MVA16

Pannello parafiamma retro piano cottura
Flame guard panel for rear of hob

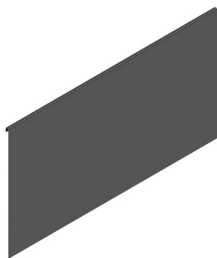

L 60 H 30 cad
W 60 H 30 each

0860MVA32

Pannello parafiamma retro piano cottura
Flame guard panel for rear of hob

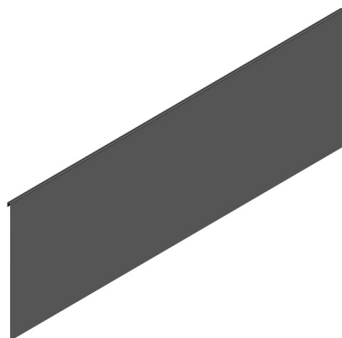

L 90 H 30 cad
W 90 H 30 each

0860MVA35



KIT BASE

Alimentazione basilare/Connessione diretta *Basic power supply/Direct connection*

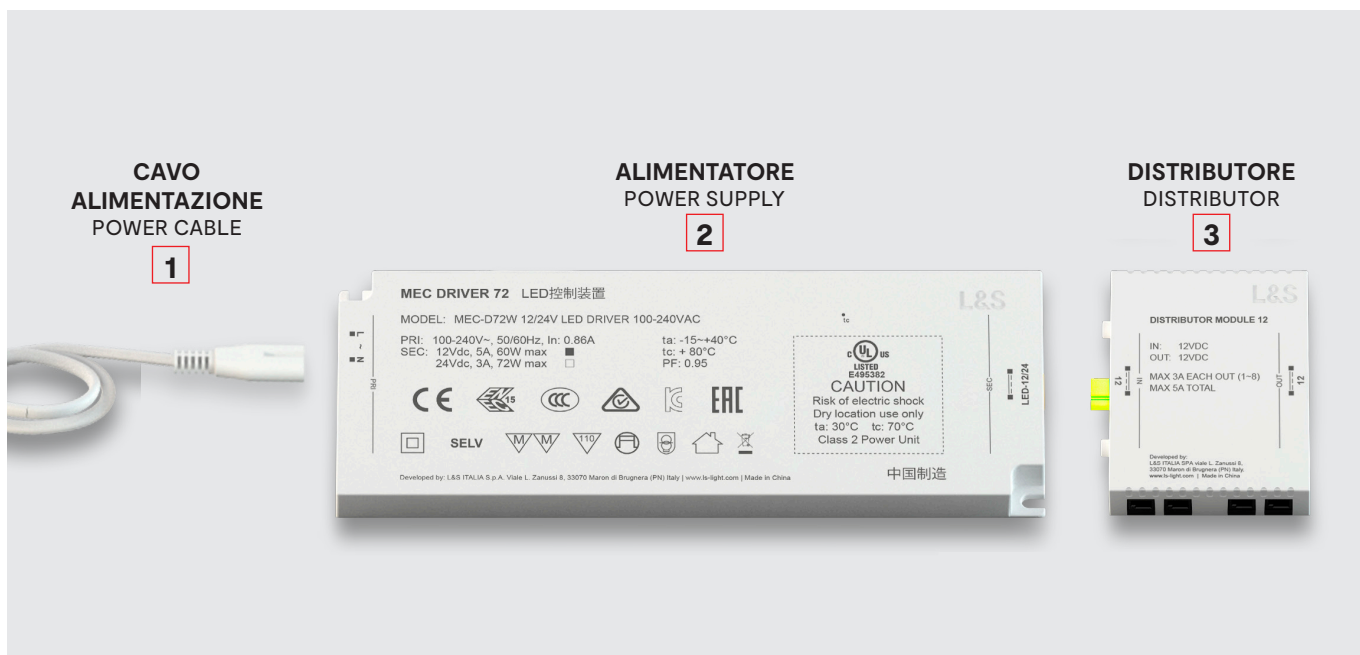

Composto da:

- 1) CAVO ALIMENTAZIONE (EU/USA/Canada)
- 2) ALIMENTATORE **in base alla potenza necessaria**
- 3) DISTRIBUTORE

Composed of:

- 1) POWER CABLE (EU/USA/Canada)
- 2) POWER SUPPLY **according to the power request**
- 3) DISTRIBUTOR

KIT ALIMENTAZIONE EUROPA **EUROPE POWER SUPPLY KIT**

KIT EUROPA	POWER	OUTPUT	codice code
12422150000	18 W	24 V DC	08618000EU
12422160000	36 W	24 V DC	08618001EU
12422170000	48 W	24 V DC	08618002EU
12422180000	72 W	24 V DC	08618003EU
12422190000	90 W	24 V DC	08618004EU
12425890000	120 W	24 V DC	08618005EU

KIT ALIMENTAZIONE USA/CANADA **USA/CANADA POWER SUPPLY KIT**

KIT USA/CANADA	POWER	OUTPUT	codice code
12422070000	18 W	24 V DC	08618000UL
12422080000	36 W	24 V DC	08618001UL
12422080000	48 W	24 V DC	08618002UL
12422100000	60 W	24 V DC	08618003UL
12422580000	90 W	24 V DC	08618004UL

Accensione con telecomando (1 zona) Switch on with remote control (1 area)

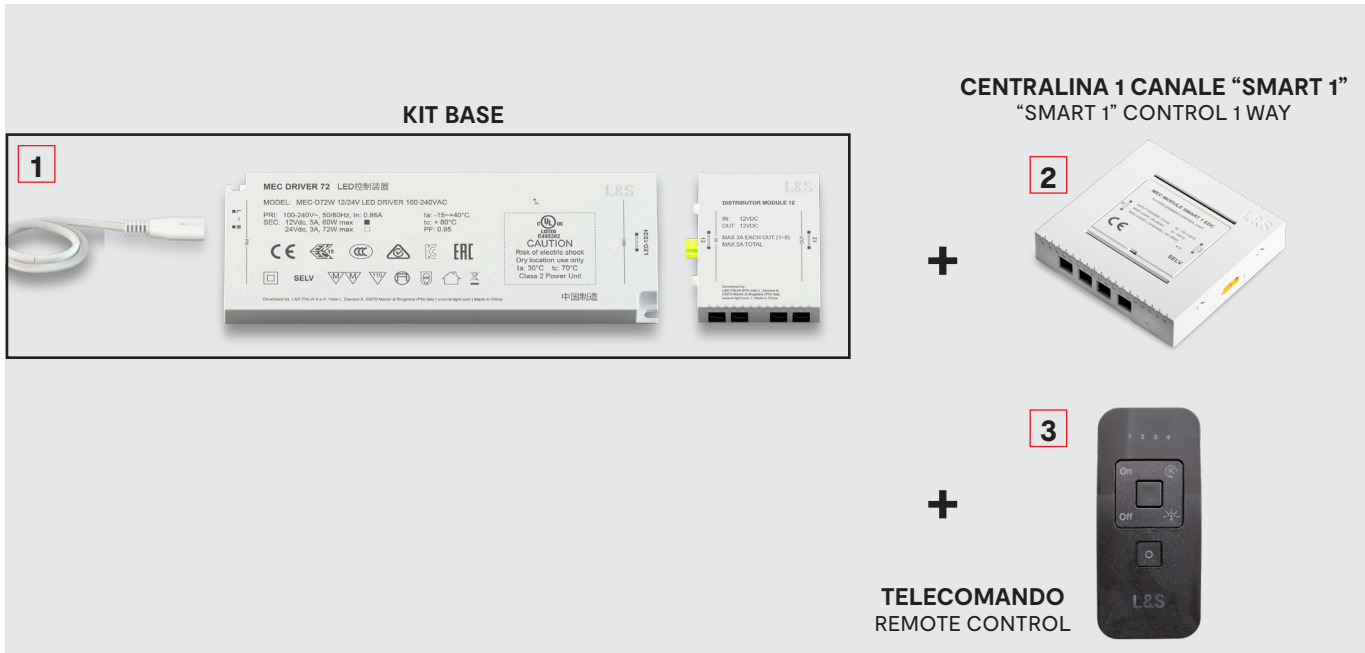

Composto da:

- 1) KIT BASE (EUROPA o USA/Canada)
- 2) CENTRALINA 1 CANALE "SMART 1"
- 3) TELECOMANDO

Composed of:

- 1) BASIC KIT (EUROPE or USA/Canada)
- 2) "SMART 1" CONTROL 1 WAY
- 3) REMOTE CONTROL

2 CENTRALINA 1 CANALE "SMART 1" "SMART 1" CONTROL 1 WAY



OUTPUT: Max 5 A total, max 3 A/output

SMART 1	TIPO	INPUT	WAYS	codice code
24201880100	EDC	24 V DC	8	08618031

La centralina *Smart 1* consente di controllare simultaneamente fino a 8 lampade in uscita con i telecomandi della linea *Smart Up 1* e *Smart Up 4*. I moduli possono essere connessi ad altri moduli di distribuzione o di controllo purché si mantenga la stessa tensione in uscita.

The *Smart 1* control unit allows you to simultaneously control up to 8 output lamps with the *Smart Up 1* and *Smart Up 4* remote controls. The modules can be connected to other distribution or control modules as long as the same output voltage is maintained.

3 TELECOMANDO 4 CANALI REMOTE CONTROL 4 WAYS



SMART UP 4

- \\ On/Off - Dimmerazione - Gestione del colore
- \\ 15 m portata all'interno di edifici
- \\ Batteria CR2032 (3 anni di durata)
- \\ On/Off - Dimming - Colour management
- \\ 15 m range indoor
- \\ Battery CR2032 (3 years lasting)

SMART UP 4 (4 CANALI)	TIPO	DIMENSIONI	codice code
 24203250300	EDC	82x37x10	08618035

Accensione con app "BlueSmart" o telecomando (4 zone) Switch on with "BlueSmart" app or remote control (4 areas)

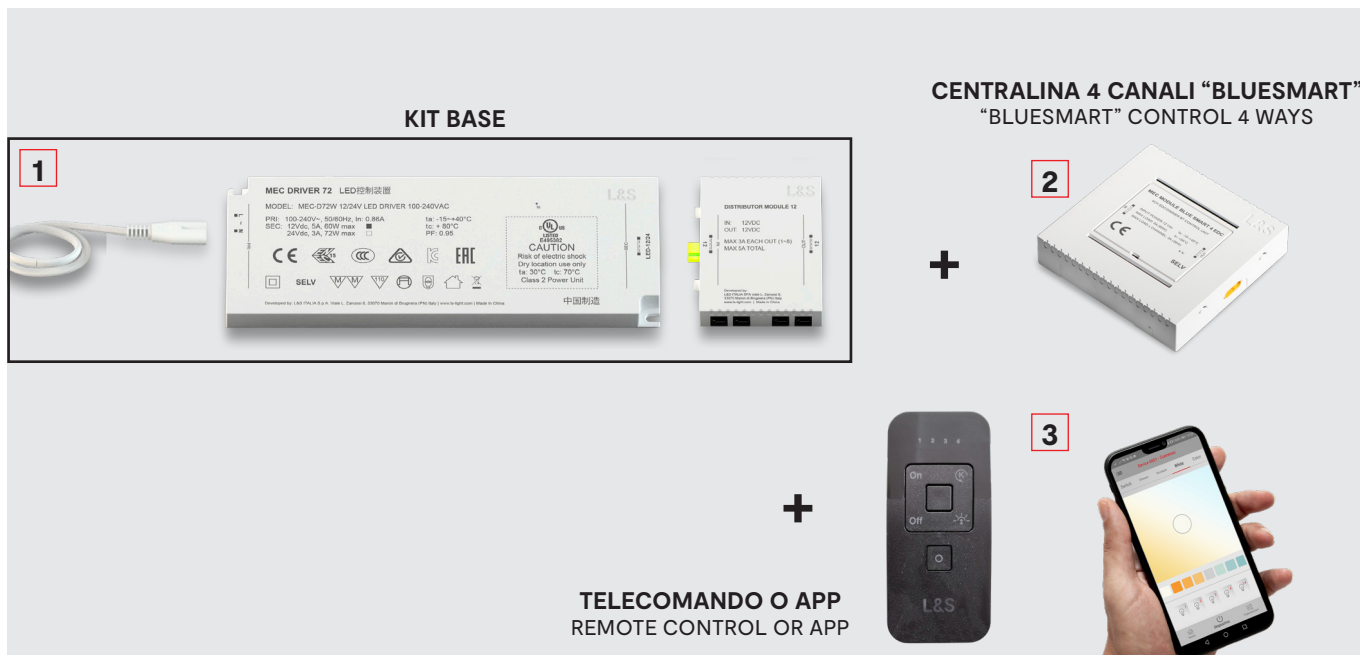

Composto da:

- 1) KIT BASE (EUROPA o USA/Canada)
- 2) CENTRALINA 4 CANALI "BLUESMART 4" (Bluetooth)
- 3) TELECOMANDO 4 CANALI "SMART UP 4" o App "BlueSmart"

Composed of:

- 1) BASIC KIT (EUROPE or USA/Canada)
- 2) "BLUESMART" CONTROL 4 WAYS (Bluetooth)
- 3) REMOTE CONTROL 4 WAYS "SMART UP 4" or "BlueSmart" App

2 CENTRALINA 4 CANALI "BLUESMART" "BLUESMART" CONTROL 4 WAYS



OUTPUT: Max 5 A total, max 3 A/output

BLUESMART	TIPO	INPUT	WAYS	codice code
24201770100	EDC	24 V DC	4	08618030

La centralina *BlueSmart* consente di controllare individualmente fino a 4 lampade in uscita tramite l'apposita app, scaricabile gratuitamente da *App Store* e *Google Play*. È inoltre compatibile con i telecomandi della linea *Smart Up 1* e *Smart Up 4*. I moduli possono essere connessi ad altri moduli di distribuzione o di controllo purché si mantenga la stessa tensione in uscita.

The *BlueSmart* control unit allows you to individually control up to 4 output lamps using the *BlueSmart* app, which can be downloaded for free from the *App Store* and *Google Play*. It is also compatible with the *Smart Up 1* and *Smart Up 4* remote controls. The modules can be connected to other distribution or control modules as long as the same output voltage is maintained.

3 TELECOMANDO 4 CANALI REMOTE CONTROL 4 WAYS



SMART UP 4

- ✓ On/Off - Dimmerazione - Gestione del colore
- ✓ 15 m portata all'interno di edifici
- ✓ Batteria CR2032 (3 anni di durata)
- ✓ On/Off - Dimming - Colour management
- ✓ 15 m range indoor
- ✓ Battery CR2032 (3 years lasting)

SMART UP 4 (4 CANALI)	TIPO	DIMENSIONI	codice code
03 24203250300	EDC	82x37x10	08618035

APP "BLUESMART" "BLUESMART" APP



Vedi spiegazioni a pagina 38.
See explanations on page 38.



ANDROID APP ON
Google Play



Download on the
App Store

MOLTIPLICATORE INGRESSI INPUT MULTIPLIER



Modalità di utilizzo
Use modality

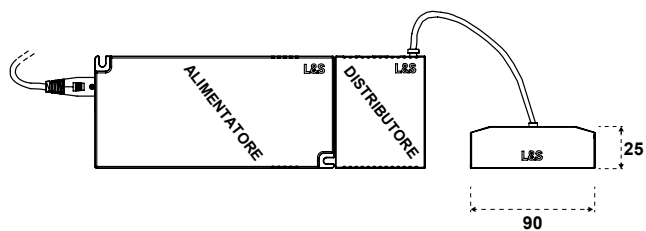

INPUT: 24 V DC

MOLTIPLICATORE	WAYS	CAVO	codice code
12606760000	10	200 mm	08618026

Il moltiplicatore di ingressi consente di collegare fino a 10 lampade per ogni ingresso del modulo. Può essere inserito su tutti i KIT.

The input multiplier allows up to 10 lamps to be connected to each input of the module. It can be inserted on all KIT.

PROLUNGA EXTENSION



INPUT: 24 V DC

PROLUNGA	CAVO	codice code
	2000 mm	08618029

Prolunga universale per tutti i prodotti. Da utilizzare in aggiunta ai cavi standard per distanze maggiori tra alimentatore e elemento luminoso.

Universal extension cable for all products. To be used in addition to standard cables for longer distances between ballast and lighting element.

COLORI IMPIALLACCIATI SP.18 VENEERED COLOURS SP.18



IMMAGINA WOOD

- FASCIA A
- Rovere naturale (opz.5442)
 - Rovere grey (opz.5443)
 - Rovere moscato (opz.5444)
 - Rovere fumè (opz.5445)
 - Rovere bianco (opz.5441)
 - Rovere nero (opz.5446)

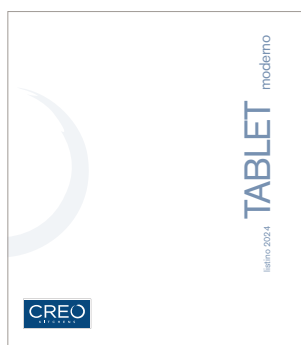

TABLET WOOD

- FASCIA A
- Rovere naturale (opz.5442)
 - Rovere grey (opz.5443)
 - Rovere moscato (opz.5444)
 - Rovere fumè (opz.5445)
 - Rovere bianco (opz.5441)
 - Rovere nero (opz.5446)

PANNELLO IMPIALLACCIATO VENATURA ORIZZONTALE HORIZONTAL GRAIN VENEERED PANEL

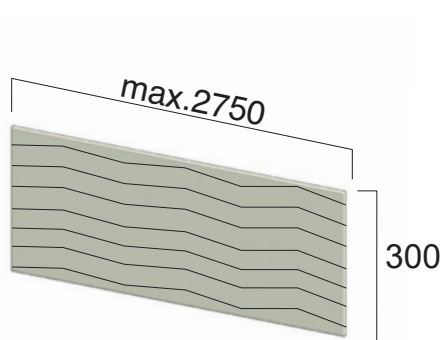

TIPOLOGIA
Type
Wood

CODICE
Code
094520MW

COSTO AL MQ
Cost per squadre meter

PANNELLO IMPIALLACCIATO VENATURA VERTICALE VERTICAL GRAIN VENEERED PANEL

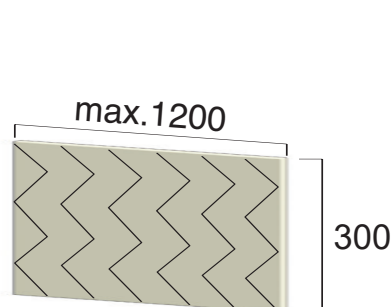

TIPOLOGIA
Type
Wood

CODICE
Code
094520MVW

COSTO AL MQ
Cost per squadre meter

N.B.: minimo fatturabile 0,5 mq.
Note: 0,5 square meter, min.quantity that can be invoiced

COLORI MATHERA
MATHERA COLOURS



IMMAGINA

- Areia beige (opz.MT02)
- Areia grigio (opz.MT03)
- Areia nero (opz.MT04)
- Gipso verde (opz.MT22)
- Gipso rosso (opz.MT24)
- Gipso grigio (opz.MT23)
- Selce grigio chiaro (opz.MT13)
- Selce nero (opz.MT14)

PANNELLO SP18 VENATURA VERTICALE E TINTA UNITA
PANEL SP18 VERTICAL GRAIN AND SOLID COLOR

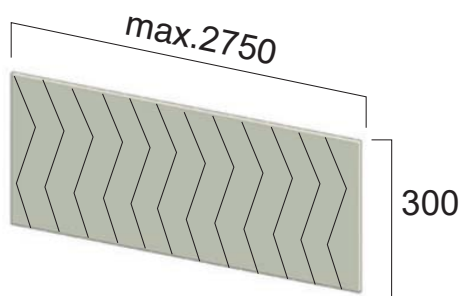

N.B.: solo per finiture selce
Note: only for flint finishes

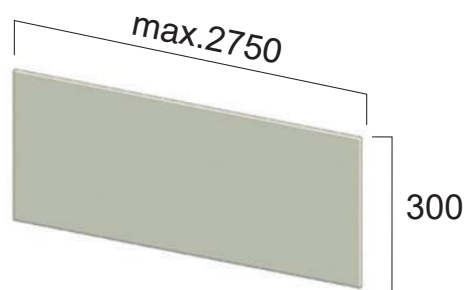

TIPOLOGIA
Type
Mathera

CODICE
Code
094513V

COSTO AL MQ
Cost per squadre meter

PANNELLO SP18 VENATURA ORIZZONTALE
SP18 PANEL HORIZONTAL GRAIN

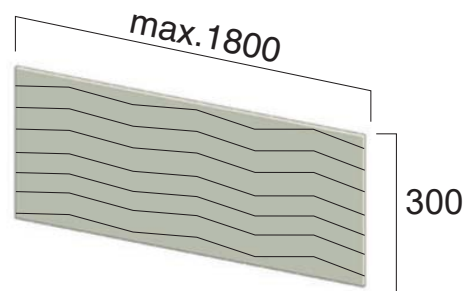

N.B.: solo per finiture selce
Note: only for flint finishes

TIPOLOGIA
Type
Mathera

CODICE
Code
094513

COSTO AL MQ
Cost per squadre meter

N.B.: minimo fatturabile 0,5 mq.
Note: 0,5 square meter, min.quantity that can be invoiced

COLORI MELAMINICI MELAMINE COLOURS



IMMAGINA

- FASCIA A**
- Salix brown (opz.1521)
 - Salix grey (opz.1522)
 - Rovere chiaro (opz.5325)
 - Rovere duna (opz.5326)
 - Abies moka (opz.4410)
 - Abies bistro (opz.4411)
 - Rovere grigio chiaro (opz.5328)
 - Rovere grafite (opz.5327)
 - Castagno bianco (opz.3055)
 - Cansiglio terra bruciata (opz.1562)
 - Verde marino (opz.8402N)
 - Rosso cardinale (opz.8123)
- FASCIA B**
- Marmo white yule (opz.9645)
 - Marmo venato grigio (opz.8870)
 - Ottone chiaro (opz.7707)
 - Rame brunito (opz.8868)
 - Peltro (opz.9666)

- Platino ossidato (opz.9661)
- Nichel ossidato (opz.9660)
- Oxide (opz.8871)
- Bianco cristallo malta (opz.7445)
- Grigio nebbia malta (opz.9626)
- Juta malta (opz.8863)
- Lavagna malta (opz.9627)
- Juta stone (opz.9634)
- Grey stone (opz.9635)
- Bronze stone (opz.8869)
- Kea (opz.9646)
- Bianco assoluto (opz.7450)

- Grigio chiaro (opz.9640)
- Dove grey (opz.8971)
- Antracite (opz.9643)
- Rigatino verticale arena (opz.9647V)
- Rigatino orizzontale arena (opz.9647O)
- Rigatino verticale laguna (opz.9648V)
- Rigatino orizzontale laguna (opz.9648O)
- Porcellana (opz.7703N)
- Light cream (opz.7706)
- Ebano (opz.8872)
- Ecrù (opz.9641)



READY

- FASCIA A**
- Frassino bianco (opz.2402)
 - Noce ghiaccio (opz.2366)
 - Noce biondo (opz.2367)
 - Noce termocotto (opz.2368)
 - Rovere naturale (opz.5329)
 - Bianco (opz.7447N)
 - Desert (opz.8914N)
 - Monumento (opz.9657)
 - Rosso minio (opz.8124)
 - Sale (opz.7451)
 - Roccia (opz.8877)
 - Piombo (opz.9649)

UNICA

- FASCIA A**
- Pagos nuvola (opz.1567)
 - Pagos bianco (opz.1566)
 - Rovere perla (opz.5314)
 - Platino (opz.9661)
 - Pietra grey (opz.9642)
 - Bianco assoluto (opz.7450)
 - Ecrù (opz.9641)
 - Antracite (opz.9643)
 - Dove grey (opz.8971)
 - Pagos Kapok (opz.1560)
- FASCIA B**
- Pietra fulvus (opz.8867)
 - Pietra musk (opz.8403)

- Pagos vulcano (opz.1568)
- Grigio chiaro (opz.9640)



TABLET

- FASCIA A**
- Sete antica (opz.7709)
 - Brina (opz.9656)
 - Monumento (opz.9657)
 - Urgano (opz.9658)
 - Nero (opz.7864)
 - Verde giada (opz.8915)
 - Verde rugiada (opz.8404)
 - Corniola (opz.8125)
 - Rosso minio (opz.8124)
 - Nativo (opz.4601)
 - Ghiaccio (opz.2372)
 - Barrique (opz.2374)
 - Nuvola (opz.2373)
 - Sale (opz.7451)
 - Rena (opz.7708)
 - Roccia (opz.8877)
 - Piombo (opz.9649)

- FASCIA B**
- Marmo white yule (opz.9645)
 - Marmo venato grigio (opz.8870)
 - Olio (opz.5323)
 - Botte (opz.5324)
 - Brown (opz.2371)
 - Tabià (opz.5309)
 - Ortisei (opz.5305)
 - Silver (opz.9654)
 - Bronze (opz.9655)
 - Caravella dark (opz.8876)
 - Caravella light (opz.8875)
 - Miele (opz.8215)
 - Cognac (opz.8878)
 - Pietra fulvus (opz.8867)
 - Pietra musk (opz.8403)
 - Ottone chiaro (opz.7707)
 - Rame brunito (opz.8868)
 - Peltro (opz.9666)
 - Elegant (opz.2409)
 - Dark (opz.2410)

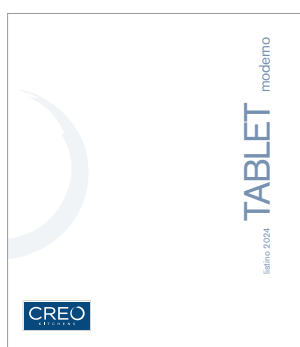

COLORI MELAMINICI
MELAMINE COLOURS

PANNELLO MELAMINICO TINTE UNITE E VENATURE ORIZZONTALI
MELAMINE PANEL WITH SOLID COLOURS AND HORIZONTAL GRAIN

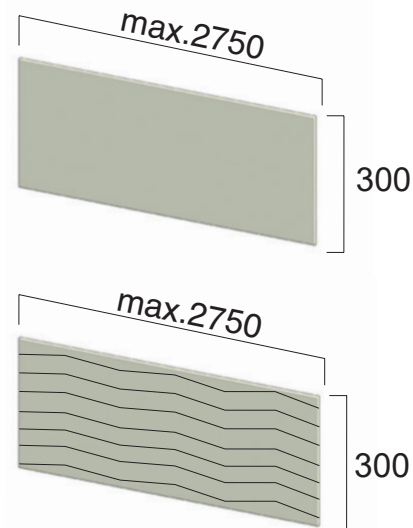

TIPOLOGIA Type	CODICE Code	COSTO AL MQ Cost per square meter
Melaminico melamine Tablet	094506M	
Melaminico melamine Ready	094506M	
Melaminico melamine Immagina	094506M	
Melaminico melamine Unica	094506M	

PANNELLO MELAMINICO VENATURE VERTICALI
MELAMINE PANEL WITH VERTICAL GRAIN

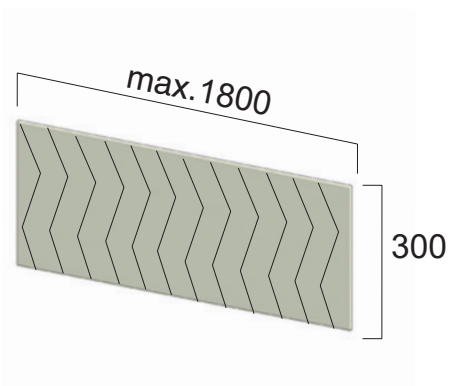

TIPOLOGIA Type	CODICE Code	COSTO AL MQ Cost per square meter
Melaminico melamine Tablet	094506MV	
Melaminico melamine Ready	094506MV	
Melaminico melamine Immagina	094506MV	
Melaminico melamine Unica	094506MV	

PANNELLO PET VENATURA VERTICALE
PET PANEL VERTICAL GRAIN

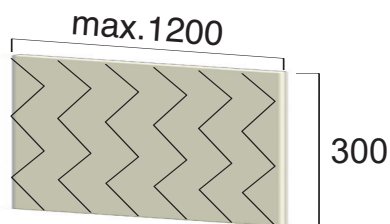

TIPOLOGIA Type	CODICE Code	COSTO AL MQ Cost per square meter
Pet pet Immagina	094640V	

N.B.: minimo fatturabile 0,5 mq.
Note: 0,5 square meter, min.quantity that can be invoiced

COLORI LACCATI UV UV LACQUERED COLOURS



IMMAGINA

FASCIA A		
	Bianco opaco (opz.7405)	Bianco lucido (opz.7406)
	Bianco neve opaco (opz.7407)	Desert lucido (opz.8942)
	Desert opaco (opz.8941)	Polvere lucido (opz.9530)
	Polvere opaco (opz.9529)	Antracite lucido (opz.9559)
	Beige colorado opaco (opz.7777)	Nero lucido (opz.7896)
	Antracite opaco (opz.9558)	Grigio minerale lucido (opz.9524)
	Nero opaco (opz.7895)	Rosso cameo lucido (opz.8164)
	Grigio minerale opaco (opz.9523)	Beige colorado lucido (opz.7778)
	Blu cobalto opaco (opz.8383)	
	Verde malga opaco (opz.8477)	
	Rosso cameo opaco (opz.8160)	
	Giallo cadmio opaco (opz.8255)	
	Verde nilo opaco (opz.8475)	
	Rosso velvet opaco (opz.8168)	

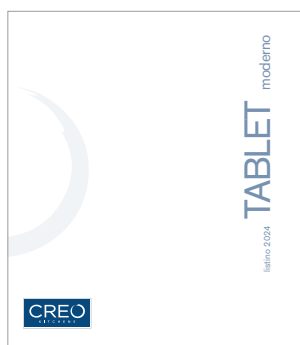

TABLET

FASCIA A		
	Bianco opaco (opz.7405)	Bianco lucido (opz.7406)
	Bianco neve opaco (opz.7407)	Desert lucido (opz.8942)
	Desert opaco (opz.8941)	Polvere lucido (opz.9530)
	Polvere opaco (opz.9529)	Antracite lucido (opz.9559)
	Beige colorado opaco (opz.7777)	Nero lucido (opz.7896)
	Antracite opaco (opz.9558)	Grigio minerale lucido (opz.9524)
	Nero opaco (opz.7895)	Rosso cameo lucido (opz.8164)
	Grigio minerale opaco (opz.9523)	Beige colorado lucido (opz.7778)
	Blu cobalto opaco (opz.8383)	
	Verde malga opaco (opz.8477)	
	Rosso cameo opaco (opz.8160)	
	Giallo cadmio opaco (opz.8255)	
	Verde nilo opaco (opz.8475)	
	Rosso velvet opaco (opz.8168)	

PANNELLO SP.19 LACCATO UV PANEL THICKNESS 19 UV LACQUERED

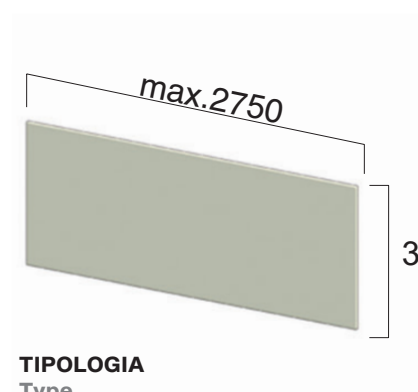

TIPOLOGIA Type

Laccato UV UV lacquered

CODICE Code

094529M

COSTO AL MQ Cost per square meter

N.B.: minimo fatturabile 0,3 mq.
Note: 0,3 square meter, min.quantity that can be invoiced

COLORI LACCATI OPACHI
MATT LACQUERED COLOURS



COLOR LAB

PER COLORI VEDI LISTINO

FOR COLOURS SEE PRICE LIST

PANNELLO SP 18 LACCATO OPACO
PET PANEL VERTICAL GRAIN

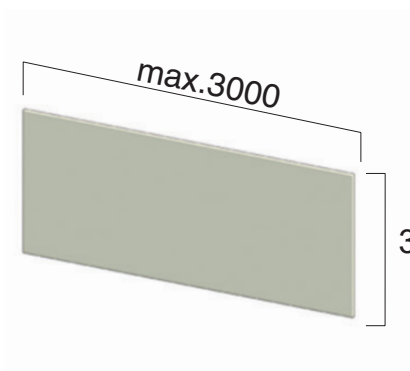

TIPOLOGIA
Type

CODICE
Code

COSTO AL MQ
Cost per square meter

Laccato

094528M

opaco super opaco

N.B.: minimo fatturabile 0,5 mq.
Note: 0,5 square meter, min.quantity that can be invoiced

Finiture Pannelli come top
Panels finishes for worktop

GRUPPOLUBE



TOP
LAMINATO
LISTINO 2024

COLORI LAMINATO COME TOP
LAMINATE COLOURS AS WORKTOP

ABS1 SP.10 mm
FENIX SP.20 mm
HPL SP.12 mm

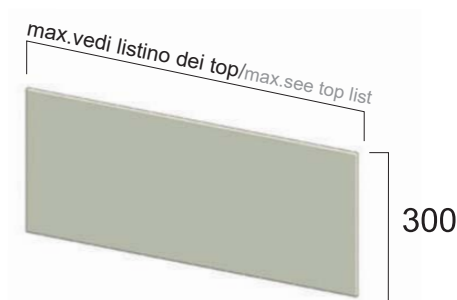

N.B. per il prezzo vedi listino top
Note: for the price see worktop price lists



N.B. pannelli sp.10 mm utilizzare gli appositi spessori forniti con spessore aggiuntivo sp.1 mm
Note: 10 mm thick panels use the appropriate shims supplied with additional 1 mm thick thickness

GRUPPOLUBE



TOP
SELECTION
LISTINO 2023

COLORI COME TOP
COLOURS AS WORKTOP

KERLITE	SP.12 mm	TKRS12
KOROS	SP.12 mm	TKSS12
GRES LAMINAM	SP.12 mm	TLNS12
INFINITY	SP.12 mm	TINS12
LITHUM	SP.12 mm	TLTS12
DEKTON	SP.20 mm	TDES20
OKITE	SP.20 mm	094022
QUARZI	SP.20 mm	TQRS20
SILESTONE	SP.20 mm	TSIS20
AGGLOMERATO DI MARMO	SP.20 mm	TAMS20

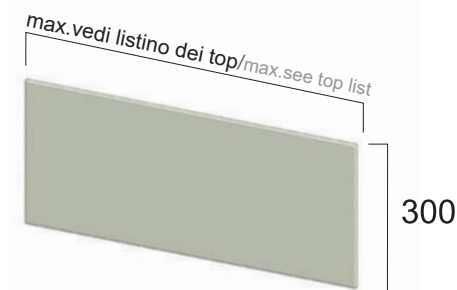

N.B. per il prezzo vedi listino top
Note: for the price see worktop price lists

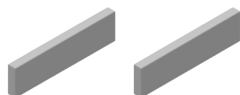

N.B. pannelli sp.12/20 mm. Per i pannelli sp.12 utilizzare gli appositi spessori forniti
Note: 12/20 mm thick panels. For 12 mm thick panels, use the appropriate shims supplied

N.B.: minimo fatturabile vedi listini top
Note: for worktop price list, min.quantity that can be invoiced

