

GRUPPOLUBE



BOISERIE HI-LINE

2023

La **Boiserie Hi-line** è un rivestimento funzionale.

Un elemento che dona al tuo arredamento un grande impatto estetico e ti permette di attrezzare la parete, personalizzandola secondo le tue esigenze. I suoi elementi modulari permettono di avere a portata di mano tutto ciò che ti serve. Le mensole ed i vari accessori, danno anche la possibilità di tenere a vista elementi decorativi e di design, valorizzando la tua composizione anche dal punto di vista estetico.

La **Boiserie**, inoltre, può essere arricchita di luci led e prese elettriche, senza la necessità di dover per forza canalizzare la parete per l'impianto elettrico.

Boiserie Hi-line is a functional covering.

An element that allow to have a great aesthetic impact and also to equip the wall, customizing it according to your needs. Its modular elements are thought for having everything you need on hand. The shelves and accessories give the possibility to keep in sights decorative and design elements, enphatizing the furniture also from aesthetical point of view.

Furthermore, the **Boiserie** can be enriched with LED lights and electrical sockets, without modify the electrical system.







La **Boiserie Hi-line**, permette di personalizzare e trasformare non solo la zona cucina ma tutti gli ambienti della casa rendendo gli spazi più eleganti e funzionali. Questa soluzione può diventare una scelta valida anche negli interni dallo stile più contemporaneo.

The **Boiserie Hi Line** allows you to customize not only the kitchen area but also all house spaces, making them more elegant and functional. This solution maybe become a valid choice for contemporary style interiors.

Categorie

categories

SOVRATOP OVERTOP



Soluzione inserita tra pensile e top.
Possibilità di variante con luce LED
nel profilo superiore.

Solution between kitchen cabinet
and top. Its possible to choose the
variant with LED light in the upper
profile.

ANGOLO CORNER



Modulo per soluzioni personalizzate
adattabili anche nelle situazioni in
cui sono presenti pareti con angolo.

Module for customized solutions,
adaptable for situations with
corner walls.

PARETE WALL



Pannellature attrezzate da terra,
pensate per trovare continuità con le
modularità della cucina.

Panels equipped from the ground,
designed to find continuity with the
kitchen's modularity.

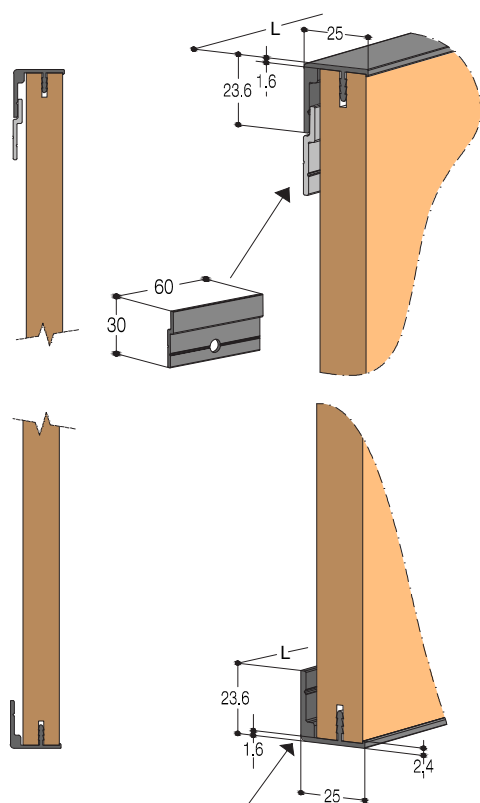

Profilo con fori asolati per fissaggio a parete
Profile with slotted holes for wall fixing

PROFILO CHIUSURA SUPERIORE/INFERIORE TOP/BOTTOM CLOSING PROFILE

Lunghezza max di taglio 3000 mm
Max cutting length 3000 mm

FINITURA Finish	A/V*	CODICE Code
■ Nero black	A	086BHL01AL11
■ Titanio titanium	A	086BHL01AL12

- Profilo di chiusura superiore - compresi N.2 piastrini per aggancio a muro ogni 50 cm;
- Top closing profile - including 2 wall attachment plates every 50 cm;

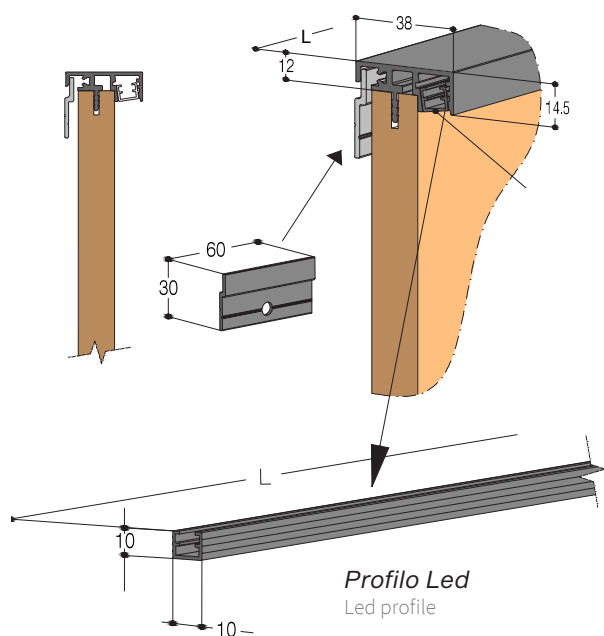

Profilo Led
Led profile

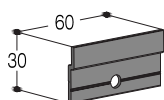

Kit piastrini fissaggio a parete
inclusi con il profilo Boiserie
(n.2 piastrini Mtl.)
Wall fixing plate kit
included with the Boiserie profile
(n.2 plates Mtl.)

PROFILO CHIUSURA SUPERIORE CON LED UPPER CLOSING PROFILE WITH LED

Lunghezza max di taglio 3000 mm
Max cutting length 3000 mm

FINITURA Finish	A/V*	CODICE Code
■ Nero black	A	086BHL06AL11
■ Titanio titanium	A	086BHL06AL12

- Profilo superiore e barra LED - Dual Color 3000/4000k compreso - NON INSTALLATA; assorbimento 11,4 Watt/M
- Prolunga di 4 mt lineari
- Upper profile and LED bar - Dual Color 3000/4000k included - but NOT INSTALLED; absorption 11.4 Watt/M
- Extension of 4 linear meters

*A/V: A=ANODIZZATO V=VERNICIATO
ANODIZED PAINTED

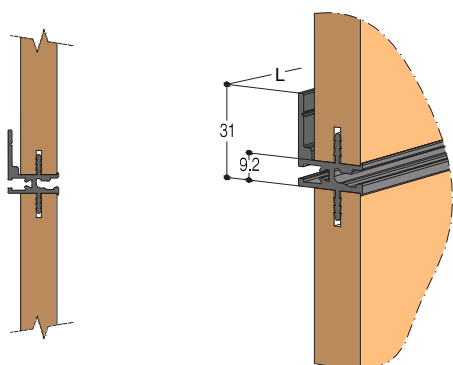

PROFILO INTERMEDIO PER PANNELLI LEGNO
INTERMEDIATE PROFILE FOR WOOD PANELS

Lunghezza max di taglio 3000 mm
Max cutting length 3000 mm

FINITURA Finish	A/V*	CODICE Code
■ Nero black	A	086BHL03AL11
■ Titanio titanium	A	086BHL03AL12

- Profilo intermedio CON SPINA SOPRA/SOTTO;
- Intermediate profile WITH PLUG ABOVE/BELOW,

Profilo con fori asolati per fissaggio a parete
Profile with slotted holes for wall fixing

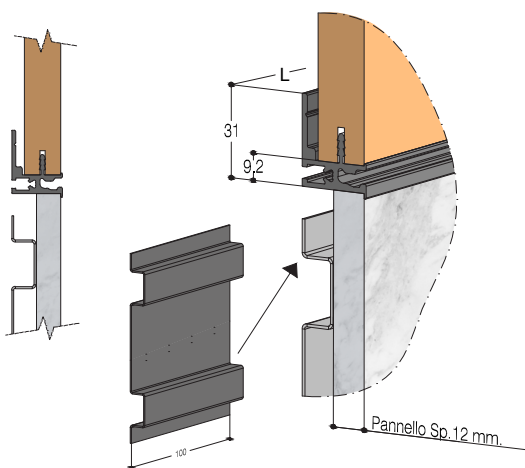

PROFILO INTERMEDIO PER PANNELLI IN COMPOSITO
INTERMEDIATE PROFILE FOR COMPOSITE PANELS

Lunghezza max di taglio 3000 mm
Max cutting length 3000 mm

FINITURA Finish	A/V*	CODICE Code
■ Nero black	A	086BHL04AL11
■ Titanio titanium	A	086BHL04AL12

- Profilo intermedio CON SPINA SOPRA- SENZA SPINA SOTTO;
- Intermediate profile WITH PLUG ABOVE - WITHOUT PLUG BELOW;

Profilo con fori asolati per fissaggio a parete
Profile with slotted holes for wall fixing

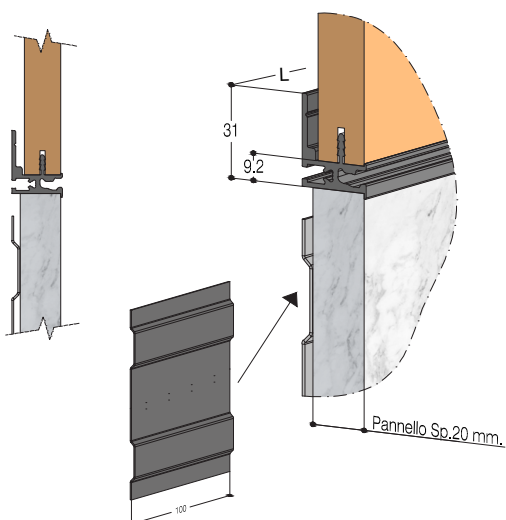

N.B.: Solo per boiserie sopratop
Note: Only for boiserie worktop

*A/V: A=ANODIZZATO V=VERNICIATO
ANODIZED PAINTED

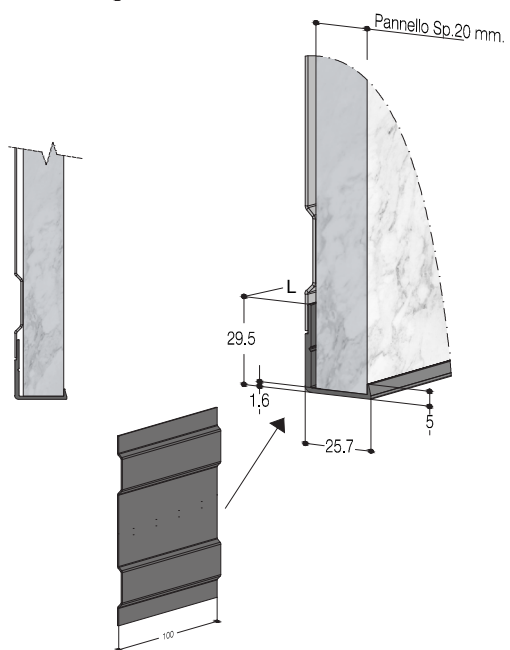
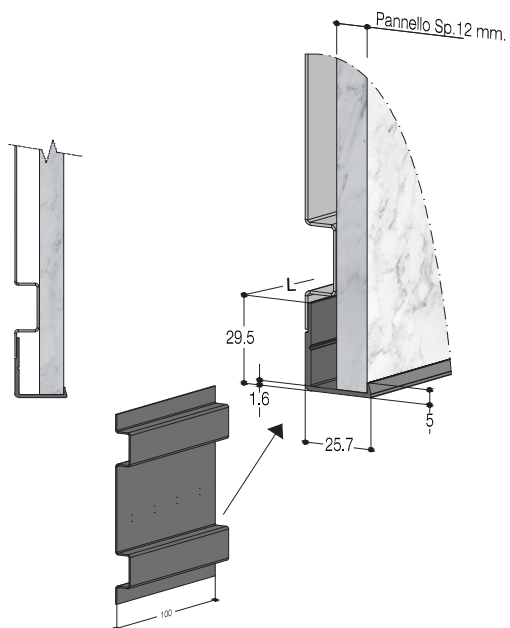

PROFILO CHIUSURA INF. PER MATERIALI COMPOSITI
BOTTOM CLOSING PROFILE FOR COMPOSITE MATERIALS

Lunghezza max di taglio 3200 mm
Max cutting length 3200 mm

FINITURA Finish	A/V*	CODICE Code
■ Nero black	A	086BHL02AL11
■ Titanio titanium	A	086BHL02AL12

- Profilo inferiore SENZA SPINA;
- Bottom profile WITHOUT PLUG

N.B.: Solo per boiserie sopratop
Note: Only for boiserie worktop

Lamiere compensazione Compensating sheets

N.B.: per pannello sp.20

Note: for panel th.20

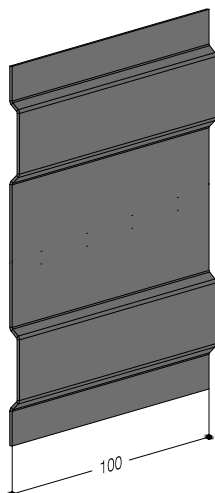

COPPIA DI COMPENSATORI PER PANNELLI SP.12-20 MM PAIR OF COMPENSATORS FOR PANELS THICKNESS 12-20 MM

FINITURA Finish	A/V'	CODICE Code
■ Grezzo raw	A	086BHL11

**N.B.: Considerare una coppia di compensatori ogni metro di
composizione**

Note: Consider a pair of compensators for every meter of composition

N.B.: per pannello sp.12

Note: for panel th.12

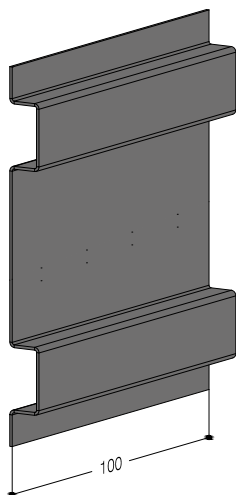

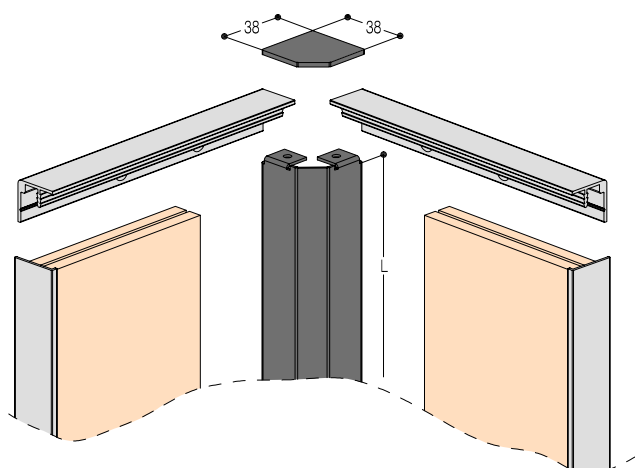

PROFILO ANGOLARE C/PIASTRINO DI CHIUSURA
ANGULAR PROFILE WITH CLOSING COVER

Dimensioni piastrino L.38xP.38 mm
Cover dimension L.38xP.38 mm.

FINITURA Finish	A/V*	CODICE Code
■ Nero black	A	086BHL08AL11
■ Titanio titanium	A	086BHL08AL12

- Profilo angolo con piastrino di chiusura;
- Corner profile with closing plate;

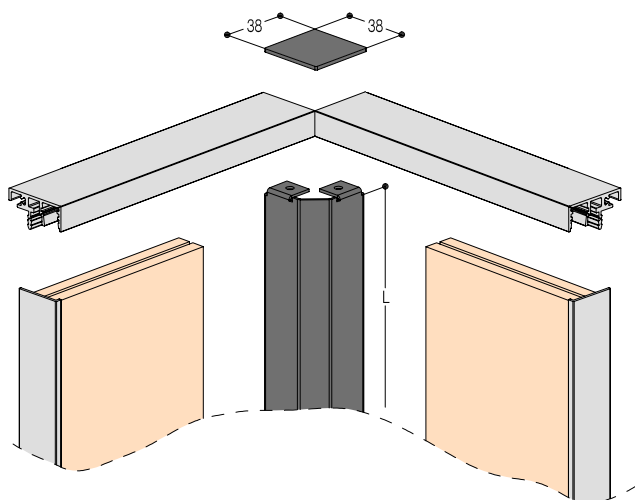

PROFILO ANGOLARE C/PIASTRINO DI CHIUSURA PER LED
ANGULAR PROFILE WITH CLOSING COVER FOR LED

Dimensioni piastrino L.38xP.38 mm
Cover dimension L.38xP.38 mm.

FINITURA Finish	A/V*	CODICE Code
■ Nero black	A	086BHL09AL11
■ Titanio titanium	A	086BHL09AL12

- Profilo angolo con piastrino di chiusura;
- Corner profile with closing plate;

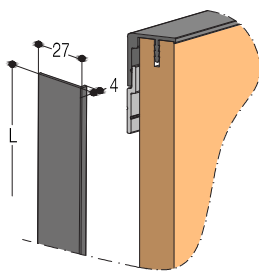

PROFILO INTERMEDIO DI CHIUSURA VERTICALE
VERTICAL INTERMEDIATE CLOSING PROFILE

FINITURA Finish	A/V'	CODICE Code
■ Nero black	A	086BHL07AL11
■ Titanio titanium	A	086BHL07AL12

N.B.: Se si supera la lunghezza massima dei pannelli e si vogliono accostare piu' moduli per allungare la composizione tra questi vanno sempre inseriti i profili intermedi in accosto.

Note: If you exceed the maximum length of the panels and you want to combine several modules to lengthen the composition between them the intermediate profiles must always be inserted side by side.

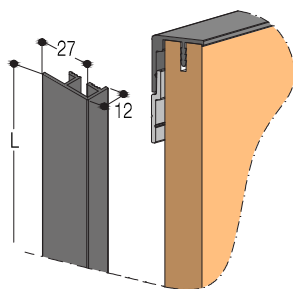

PROFILO DI CHIUSURA LATERALE L 12
LATERAL CLOSING W 12 PROFILE

FINITURA Finish	A/V'	CODICE Code
■ Nero black	A	086BHL12AL11
■ Titanio titanium	A	086BHL12AL12

N.B.: Profilo laterale obbligatorio ad inizio/fine composizione
Note: Mandatory side profile at the start/end of the composition

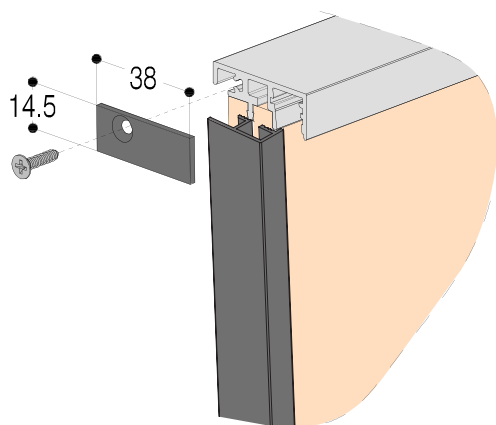

COPPIA TAPPI CHIUSURA (DX/SX) PER BARRA BOISERIE C/LED
CAPS PAIR OF CLOSURES (R/L) FOR WOODEN BAR W/LED

FINITURA Finish	A/V'	CODICE Code
■ Nero black	A	086BHL10AL11
■ Titanio titanium	A	086BHL10AL12

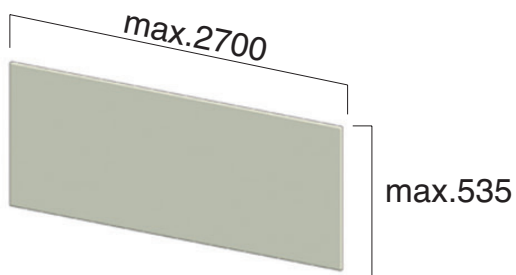

PANNELLO CON FRESATA SUPERIORE E INFERIORE
(Utilizzabile su tutte le tipologie di Boiserie)
PANEL WITH UPPER AND LOWER MILLING
(Can be used on all types of Boiserie)

TIPOLOGIA
Type

CODICE
Code

Melaminico melamine Tablet	086BHP01
Melaminico melamine Ready	086BHP01
Melaminico melamine Immagina	086BHP01
Melaminico melamine Unica	086BHP01
Laminato come top laminate same as worktop	086BHP01
Laccato UV UV lacquered	086BHP01
Fenix	086BHP01

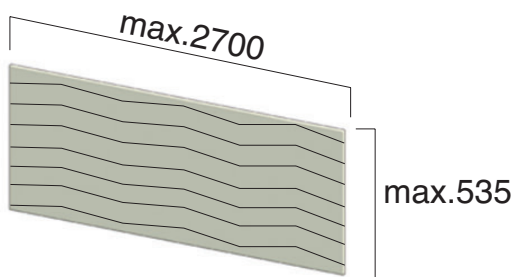

PANNELLO CON FRESATA SUP. E INF. VENATURA VERTICALE
(Utilizzabile su tutte le tipologie di Boiserie)
PANEL WITH UPPER AND LOWER MILLED VERTICAL GRAIN
(Can be used on all types of Boiserie)

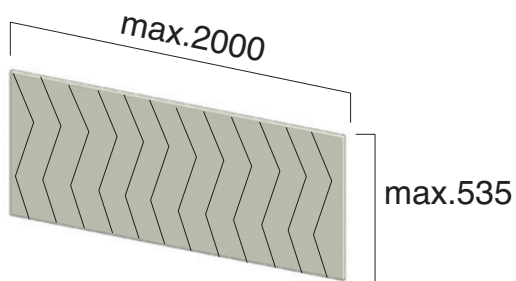

TIPOLOGIA
Type

CODICE
Code

Melaminico melamine Tablet	086BHP03
Melaminico melamine Ready	086BHP03
Melaminico melamine Immagina	086BHP03
Melaminico melamine Unica	086BHP03

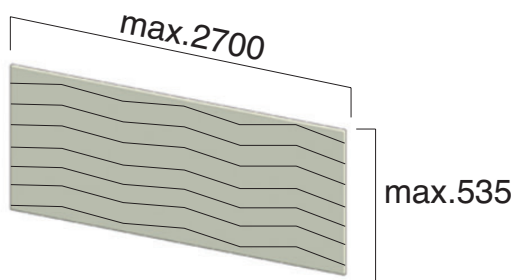

PANNELLO CON FRESATA SUP. E INF. IMPIALLACCIATO VENATURA ORIZZONTALE
(Utilizzabile su tutte le tipologie di Boiserie)
PANEL WITH MILLING UPPER AND LOWER HORIZONTAL GRAIN VENEERED
(Can be used on all types of Boiserie)

TIPOLOGIA Type	CODICE Code
Wood	086BHP04
Impiallacciato veneered Clover	086BHP04
Impiallacciato veneered Flavour	086BHP04
Impiallacciato veneered Luna	086BHP04
Impiallacciato veneered Oltre	086BHP04

N.B.: Costi riferiti al MQ
Note: Cost referred per squadre meter

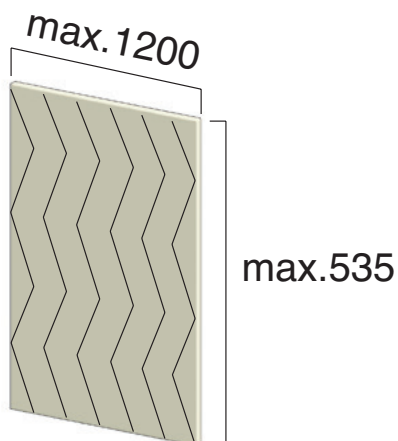

PANNELLO CON FRESATA SUP. E INF. IMPIALLACCIATO VENATURA VERTICALE
(Utilizzabile su tutte le tipologie di Boiserie)
PANEL WITH UPPER AND LOWER MILLED VEENERED VERTICAL GRAIN
(Can be used on all types of Boiserie)

TIPOLOGIA Type	CODICE Code
Wood	086BHP05
Impiallacciato veneered Clover	086BHP05
Impiallacciato veneered Flavour	086BHP05
Impiallacciato veneered Luna	086BHP05
Impiallacciato veneered Oltre	086BHP05

N.B.: Costi riferiti al MQ
Note: Cost referred per squadre meter

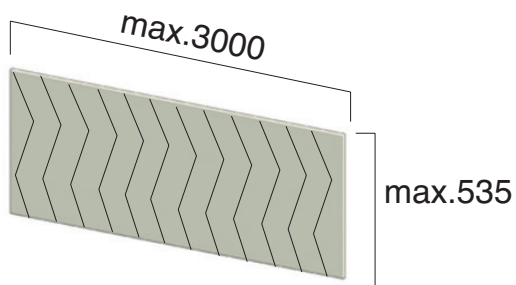

PANNELLO CON FRESATA SUPERIORE E INFERIORE
(Utilizzabile su tutte le tipologie di Boiserie)
PANEL WITH UPPER AND LOWER MILLED VERTICAL GRAIN
(Can be used on all types of Boiserie)

TIPOLOGIA
Type
Mathera

CODICE
Code
086BHP07

N.B.: solo per finiture selce
Note: only for flint finishes

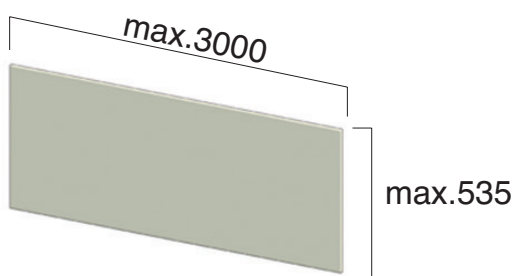

PANNELLO CON FRESATA SUP. E INF. VENATURA ORIZZONTALE
(Utilizzabile su tutte le tipologie di Boiserie)
PANEL WITH UPPER AND LOWER MILLED HORIZONTAL GRAIN
(Can be used on all types of Boiserie)

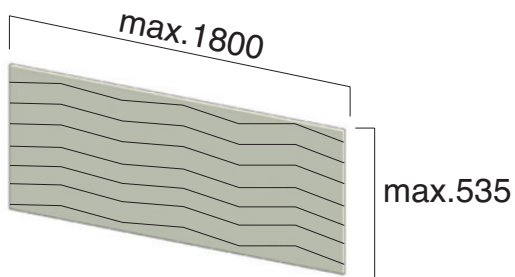

TIPOLOGIA
Type
Mathera

CODICE
Code
086BHP06

N.B.: solo per finiture selce
Note: only for flint finishes

Pannelli Panels

Durante la fase di progettazione bisogna tener presente sia del limite dimensionale del pannello (altezza e larghezza max.) che in caso di finiture materiche, dell'orientamento della venatura.

During the design phase, it is necessary to keep in mind both the panel dimensional limit (height and width max.) and in the case of finishes material, the grain orientation (vertical or horizontal).

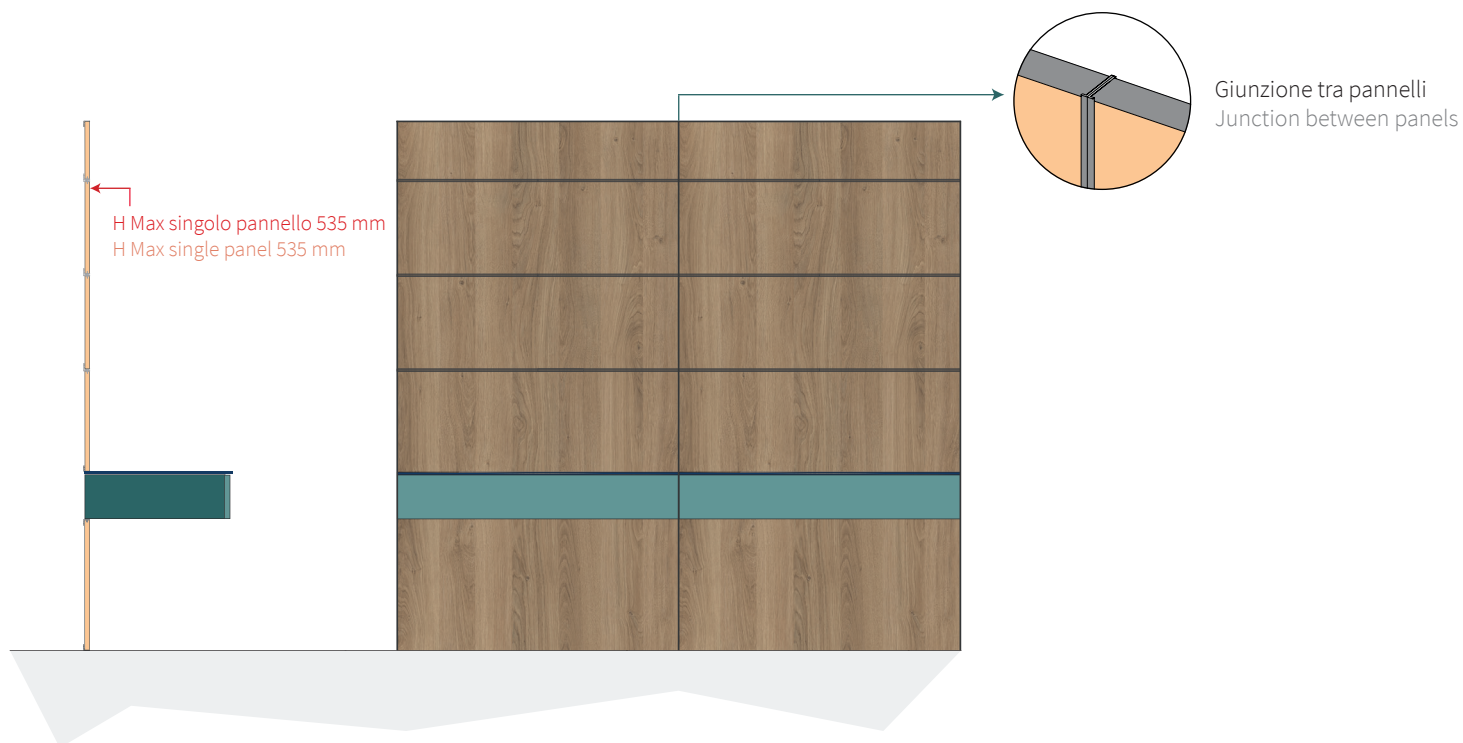

Pannelli in composito solo elemento inferiore per composizione sopratop
Composite panels only lower element for lay on worktop composition

N.B.: Solo per la tipologia di composizione tra base e top e' possibile inserire il pannello inferiore in composito nelle tipologie riportate di seguito.

Per i prezzi e caratteristiche di questi, vedi listino Top

Note: Only for the type of composition between base unit and worktop it is possible to insert the composite lower panel in the types listed below.

For the prices and features of these, see the Worktop price list

KERLITE	TKRS12
KOROS	TKSS12
GRES LAMINAM	TLNS12
INFINITY	TINS12
DEKTON	TDES20
OKITE	094022
QUARZI	TQRS20
SILESTONE	TSIS20
STRATIFICATO HPL	THPLS13
AGGLOMERATO DI MARMO	TAMS20

Finiture Pannelli

Panels finishes

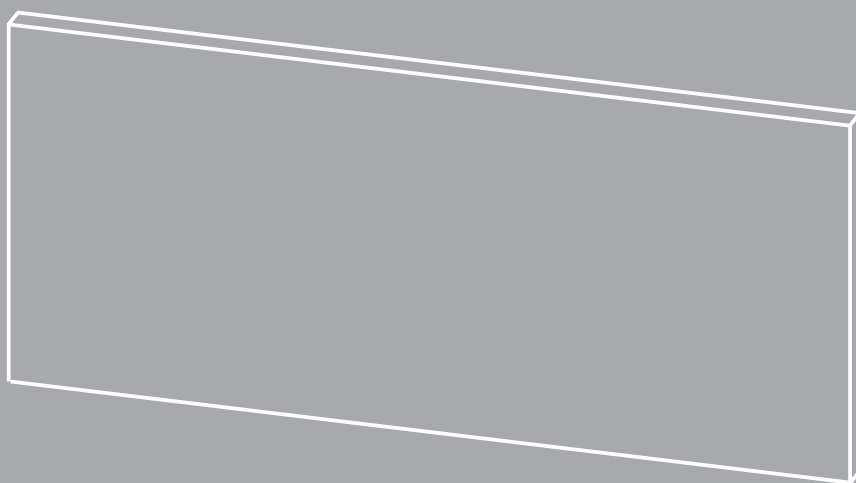

COLORI IMPIALLACCIATI VENEERED COLOURS



IMMAGINA WOOD

- FASCIA A
- Rovere naturale (opz.5442)
 - Rovere grey (opz.5443)
 - Rovere moscato (opz.5444)
 - Rovere fumè (opz.5445)
 - Rovere bianco (opz.5441)
 - Rovere nero (opz.5446)



FLAVOUR

- FASCIA A
- Frassino grigio reale (opz.2450)
 - Frassino lino (opz.2470)

- FASCIA C
- Rovere nuvola (opz.5375)
 - Rovere calce (opz.5376)
 - Rovere mielato (opz.5377)
 - Rovere asfalto (opz.5378)
 - Rovere cuoio (opz.5379)

- FASCIA B
- Frassino grigio lava (opz.2447)
 - Frassino nebbia (opz.2449)
 - Frassino bianco assoluto (opz.2466)
 - Frassino azzurro nube (opz.2467)
 - Frassino rosso persia (opz.2468)
 - Frassino nero seppia (opz.2469)

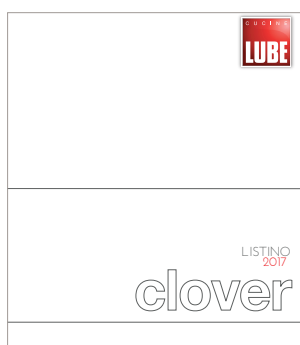

CLOVER

- FASCIA A
- Rovere grigio nebbia (opz.5401)
 - Rovere polvere (opz.5402)
 - Rovere grafite (opz.5403)
 - Rovere naturale (opz.5404)
 - Rovere tabacco (opz.5405)
 - Rovere tan (opz.5408)
 - Rovere cenere (opz.5409)

- FASCIA B
- Rovere termocotto (opz.5410)
 - Noce canaletto (opz.1324)

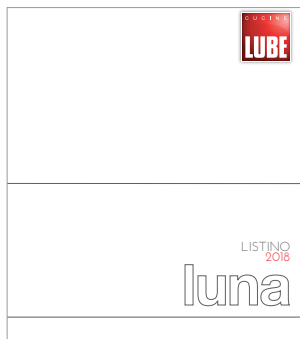

LUNA

FASCIA A

- Rovere bianco (opz.5429)
- Rovere lino (opz.5430)
- Rovere grigio traffico (opz.5431)
- Rovere grigio reale (opz.5432)
- Rovere moresco (opz.5433)
- Rovere carbon (opz.5434)
- Rovere natur (opz.5440)

FASCIA B

- Noce canaletto (opz.1331)



OLTRE

FASCIA A

- Rovere bianco invecchiato (opz.5380)
- Rovere juta invecchiato (opz.5381)
- Rovere corteccia invecchiato (opz.5382)
- Rovere mielato invecchiato (opz.5383)
- Rovere antracite invecchiato (opz.5384)
- Rovere argilla invecchiato (opz.5385)
- Rovere moro invecchiato (opz.5386)
- Rovere naturale invecchiato parquetato (opz.5387)
- Rovere madera termocotto con finto tarlo (opz.5388)
- Rovere grigio terra (opz.5389)

COLORI MELAMINICI MELAMINE COLOURS



IMMAGINA

- FASCIA A**
- Salix brown (opz.1521)
 - Salix grey (opz.1522)
 - Rovere chiaro (opz.5325)
 - Rovere duna (opz.5326)
 - Abies moka (opz.4410)
 - Abies bistro (opz.4411)
 - Rovere grigio chiaro (opz.5328)
 - Rovere grafite (opz.5327)
 - Castagno bianco (opz.3055)
 - Cansiglio terra bruciata (opz.1562)
 - Verde marino (opz.8402N)
 - Rosso cardinale (opz.8123)
- FASCIA B**
- Marmo white yule (opz.9645)
 - Marmo venato grigio (opz.8870)
 - Ottone chiaro (opz.7707)
 - Rame brunito (opz.8868)
 - Peltro (opz.9666)

- Platino ossidato (opz.9661)
- Nichel ossidato (opz.9660)
- Oxide (opz.8871)
- Bianco cristallo malta (opz.7445)
- Grigio nebbia malta (opz.9626)
- Juta malta (opz.8863)
- Lavagna malta (opz.9627)
- Juta stone (opz.9634)
- Grey stone (opz.9635)
- Bronze stone (opz.8869)
- Kea (opz.9646)
- Bianco assoluto (opz.7450)

- Grigio chiaro (opz.9640)
- Dove grey (opz.8971)
- Antracite (opz.9643)
- Rigatino verticale arena (opz.9647V)
- Rigatino orizzontale arena (opz.9647O)
- Rigatino verticale laguna (opz.9648V)
- Rigatino orizzontale laguna (opz.9648O)
- Porcellana (opz.7703N)
- Light cream (opz.7706)
- Ebano (opz.8872)
- Ecrù (opz.9641)



READY

- FASCIA A**
- Frassino bianco (opz.2402)
 - Noce ghiaccio (opz.2366)
 - Noce biondo (opz.2367)
 - Noce termocotto (opz.2368)
 - Rovere naturale (opz.5329)
 - Bianco (opz.7447N)
 - Desert (opz.8914N)
 - Monumento (opz.9657)
 - Rosso minio (opz.8124)
 - Sale (opz.7451)
 - Roccia (opz.8877)
 - Piombo (opz.9649)



UNICA

- FASCIA A**
- Pagos nuvola (opz.1567)
 - Pagos bianco (opz.1566)
 - Rovere perla (opz.5314)
 - Platino (opz.9661)
 - Pietra grey (opz.9642)
 - Bianco assoluto (opz.7450)
 - Ecrù (opz.9641)
 - Antracite (opz.9643)
 - Dove grey (opz.8971)
 - Pagos Kapok (opz.1560)
 - Pagos vulcano (opz.1568)
 - Grigio chiaro (opz.9640)
- FASCIA B**
- Pietra fulvus (opz.8867)
 - Pietra musk (opz.8403)

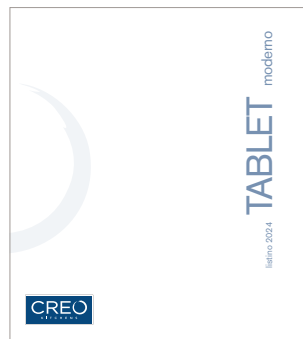

TABLET

FASCIA A	
	Sete antica (opz.7709)
	Brina (opz.9656)
	Monumento (opz.9657)
	Urgano (opz.9658)
	Nero (opz.7864)
	Verde giada (opz.8915)
	Verde rugiada (opz.8404)
	Corniola (opz.8125)
	Rosso minio (opz.8124)
	Nativo (opz.4601)
	Ghiaccio (opz.2372)
	Barrique (opz.2374)
	Nuvola (opz.2373)
	Sale (opz.7451)
	Rena (opz.7708)
	Roccia (opz.8877)
	Piombo (opz.9649)

FASCIA B	
	Marmo white yule (opz.9645)
	Marmo venato grigio (opz.8870)
	Olio (opz.5323)
	Botte (opz.5324)
	Brown (opz.2371)
	Tabià (opz.5309)
	Ortisei (opz.5305)
	Silver (opz.9654)
	Bronze (opz.9655)
	Caravella dark (opz.8876)
	Caravella light (opz.8875)
	Miele (opz.8215)
	Cognac (opz.8878)
	Pietra fulvus (opz.8867)
	Pietra musk (opz.8403)
	Ottone chiaro (opz.7707)
	Rame brunito (opz.8868)
	Peltro (opz.9666)
	Elegant (opz.2409)
	Dark (opz.2410)

COLORI LACCATI UV UV LACQUERED COLOURS



IMMAGINA

FASCIA A	Bianco opaco (opz.7405) Bianco neve opaco (opz.7407) Desert opaco (opz.8941) Polvere opaco (opz.9529) Beige colorado opaco (opz.7777) Antracite opaco (opz.9558) Nero opaco (opz.7895) Grigio minerale opaco (opz.9523) Blu cobalto opaco (opz.8383) Verde malga opaco (opz.8477) Rosso cameo opaco (opz.8160) Giallo cadmio opaco (opz.8255) Verde nilo opaco (opz.8475) Rosso velvet opaco (opz.8168)	Bianco lucido (opz.7406) Desert lucido (opz.8942) Polvere lucido (opz.9530) Antracite lucido (opz.9559) Nero lucido (opz.7896) Grigio minerale lucido (opz.9524) Rosso cameo lucido (opz.8164) Beige colorado lucido (opz.7778)
----------	--	--

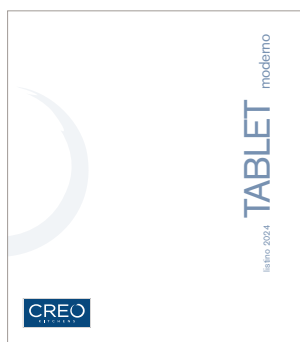

TABLET

FASCIA A	Bianco opaco (opz.7405) Bianco neve opaco (opz.7407) Desert opaco (opz.8941) Polvere opaco (opz.9529) Beige colorado opaco (opz.7777) Antracite opaco (opz.9558) Nero opaco (opz.7895) Grigio minerale opaco (opz.9523) Blu cobalto opaco (opz.8383) Verde malga opaco (opz.8477) Rosso cameo opaco (opz.8160) Giallo cadmio opaco (opz.8255) Verde nilo opaco (opz.8475) Rosso velvet opaco (opz.8168)	Bianco lucido (opz.7406) Desert lucido (opz.8942) Polvere lucido (opz.9530) Antracite lucido (opz.9559) Nero lucido (opz.7896) Grigio minerale lucido (opz.9524) Rosso cameo lucido (opz.8164) Beige colorado lucido (opz.7778)
----------	--	--











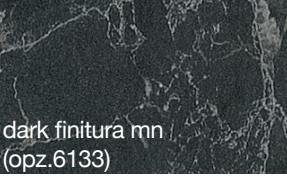
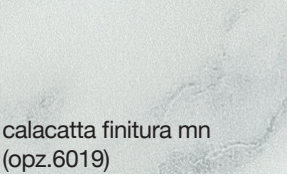
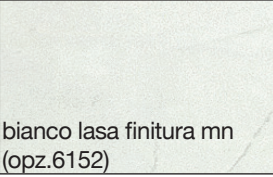
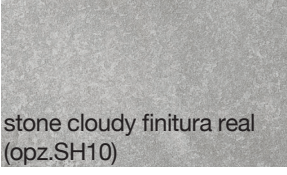
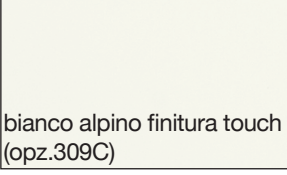
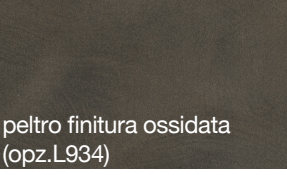

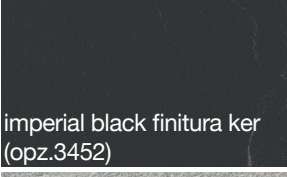
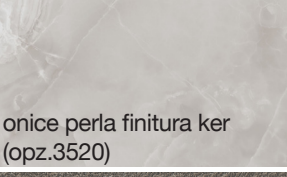

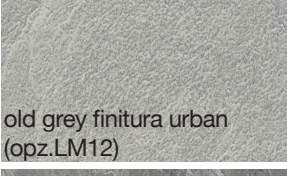
COLORI MATHERA MATHERA COLOURS

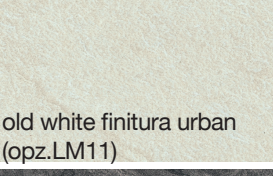
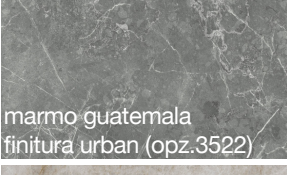



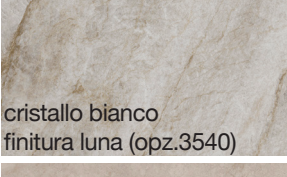
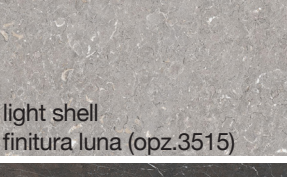
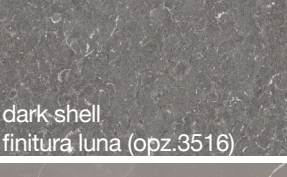
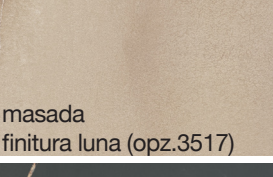
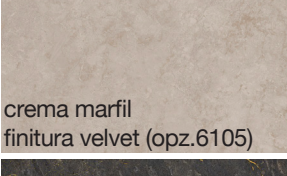

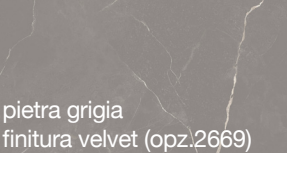
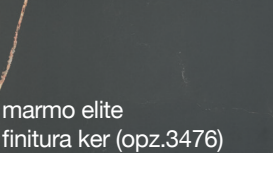

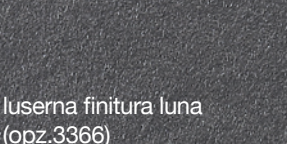



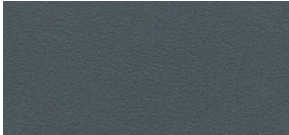
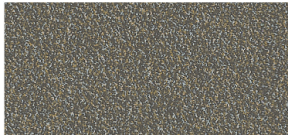

IMMAGINA

- Areia beige (opz.MT02)
- Areia grigio (opz.MT03)
- Areia nero (opz.MT04)
- Gipso verde (opz.MT22)
- Gipso rosso (opz.MT24)
- Gipso grigio (opz.MT23)
- Selce grigio chiaro (opz.MT13)
- Selce nero (opz.MT14)

COLORI LAMINATO COME TOP
LAMINATE COLOURS AS WORKTOP

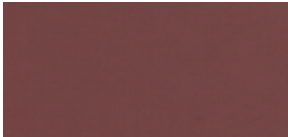
 malta visone vintage finitura plamky (opz.5568)	 dark finitura mn (opz.6133)	 calacatta finitura mn (opz.6019)	 bianco lasa finitura mn (opz.6152)
 stone cloudy finitura real (opz.SH10)	 bianco alpino finitura touch (opz.309C)	 peltro finitura ossidata (opz.L934)	 ferro finitura ossidata (opz.L933)
 imperial black finitura ker (opz.3452)	 onice perla finitura ker (opz.3520)	 kaspio oro finitura flash (opz.6089)	 brass finitura flash (opz.5025)
 old grey finitura urban (opz.LM12)	 old dark finitura urban (opz.LM13)	 old black finitura urban (opz.LM14)	 old white finitura urban (opz.LM11)
 marmo guatemala finitura urban (opz.3522)	 samas finitura urban (opz.3482)	 iron finitura touch (opz.2765)	 marmo nuvolato finitura plamky (opz.6074)
 cristallo bianco finitura luna (opz.3540)	 light shell finitura luna (opz.3515)	 dark shell finitura luna (opz.3516)	 masada finitura luna (opz.3517)
 crema marfil finitura velvet (opz.6105)	 breccia imperiale finitura velvet (opz.6101)	 pietra grigia finitura velvet (opz.2669)	 marmo elite finitura ker (opz.3476)
 vulcano oro finitura luna (opz.3536)	 luserna finitura luna (opz.3366)		

COLORI FENIX
FENIX COLOURS

 bianco caldo (opz.0032)	 castoro (opz.0717)	 fumo (opz.0718)	 nero (opz.0720)
 grigio bromo (opz.0724)	 bronzo doha (opz.2629)	 beige arizona (opz.0748)	 verde kitami (opz.0794)
 verde commodoro (opz.0750)	 rosso askya (opz.0770)	 grigio antrim (opz.0752)	 grigio aragona (opz.0793)
 blu shaba (opz.0792)			

Box alimentazione

Power supply box

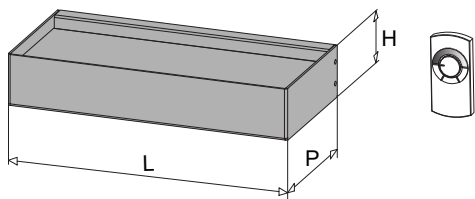

BOX ALIMENTAZIONE MENSOLA

SHELF POWER SUPPLY BOX

FINITURA Finish	A/V*	CODICE Code
■ Nero black	A	086BHM01AL11
■ Titanio titanium	A	086BHM01AL12

N.B.: disponibile solo per il mercato Europeo
Note: only available for the European market

COMPONENTI INTERNI CABLATI:

Driver 24V 100W
Dimmer
Cavetto variazione gradi K (3000\4000)
Radiocomando 12/24 V
Certificazione internazionale
Ogni box ha un massimo da collegare di 8 Led

WIRED INTERNAL COMPONENTS:

Driver 24V 100W
Dimmer
K degree variation cable (3000\4000)
12/24 V radio control
International Certification
Each box has a maximum of 8 LEDs to connect

ACCESSORI ELETTRICI (N.B.: da usare solo con punto luce comado a parete)

ELECTRICAL ACCESSORIES (Note: to be used only with wall-mounted light point)

DUAL COLOR

Distributore a 4 uscite / 4-way distribution box

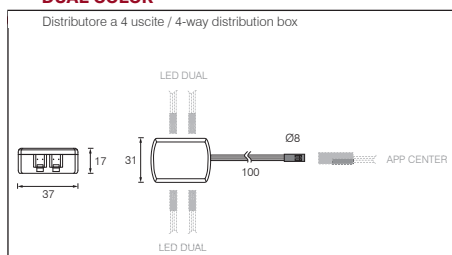

24V - 100W - CE V V V V SELV C UL US

V IN	Hz	V OUT	W	L x P x H (mm)	EU PLUG	US PLUG
110V	50..60Hz	24V	100W	184 x 61 x 32	3T494504	24V - Cavo per connessione singola / Single connecting cable / Einzelverbindun

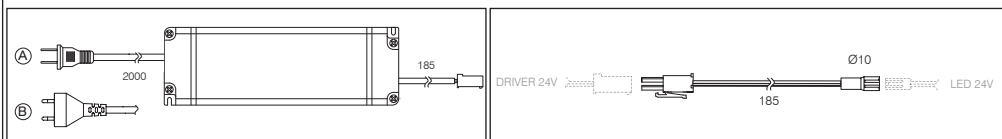

DESCRIZIONE

Description

Distributore 4 uscite distributor 4 outputs
Alimentatore US/Canada power supply
Alimentatore EU power supply
Cavo alimentazione power cable

*A/V: A=ANODIZZATO V=VERNICIATO
ANODIZED PAINTED

Box alimentazione Power supply box

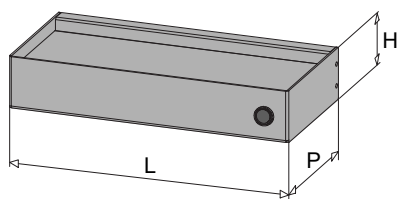

N.B.: disponibile solo per il mercato Europeo
Note: only available for the European market

BOX ALIMENTAZIONE MENSOLA C/PULSANTE POWER SUPPLY BOX SHELF WITH BUTTON

FINITURA Finish	A/V*	CODICE Code
■ Nero black	A	086BHM03AL11
■ Titanio titanium	A	086BHM03AL12

COMPONENTI INTERNI CABLATI:

Driver 24V 100W

Dimmer

Cavetto variazione gradi K (3000\4000)

Interruttore cablato

Certificazione internazionale

Ogni box ha un massimo da collegare di 8 Led

WIRED INTERNAL COMPONENTS:

Driver 24V 100W

Dimmer

K degree variation cable (3000\4000)

Wired switch

International Certification

Each box has a maximum of 8 LEDs to connect

NB: I Box vanno inseriti nella parte piu' estrema dx o sx della barra

Note: The Boxes must be inserted in the most extreme right or left part of the bar

Accessori alluminio Aluminium accessories

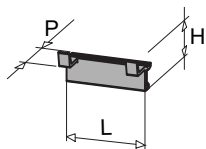

GANCIO PORTAOGGETTI DOPPIO L.80 P.38,5 H.37 DOUBLE STORAGE HOOK L.80 D.38,5 H.37

FINITURA Finish	A/V*	CODICE Code
■ Nero black	A	086BHM10AL11
■ Titanio titanium	A	086BHM10AL12

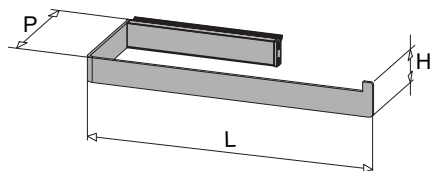

PORTAROTOLO L.294 P.115 H.25 ROLL HOLDER L.294 D.115 H.25

FINITURA Finish	A/V*	CODICE Code
■ Nero black	A	086BHM11AL11
■ Titanio titanium	A	086BHM11AL12

MENSOLA PIANA ALLUMINIO L.300 P.120 H.3 FLAT ALUMINUM SHELF L.300 D.120 H.3

FINITURA Finish	A/V*	CODICE Code
■ Nero black	A	086BHM20AL11
■ Titanio titanium	A	086BHM20AL12

MENSOLA PIANA ALLUMINIO L.450 P.120 H.3 FLAT ALUMINUM SHELF L.450 D.120 H.3

FINITURA Finish	A/V*	CODICE Code
■ Nero black	A	086BHM21AL11
■ Titanio titanium	A	086BHM21AL12

MENSOLA PIANA ALLUMINIO L.600 P.120 H.3 FLAT ALUMINUM SHELF L.600 D.120 H.3

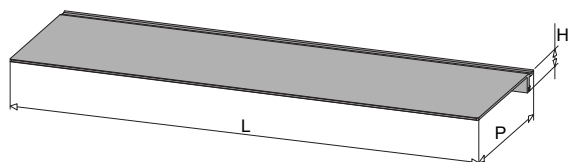

FINITURA Finish	A/V*	CODICE Code
■ Nero black	A	086BHM22AL11
■ Titanio titanium	A	086BHM22AL12

MENSOLA PIANA ALLUMINIO L.900 P.120 H.3 FLAT ALUMINUM SHELF L.900 D.120 H.3

FINITURA Finish	A/V*	CODICE Code
■ Nero black	A	086BHM23AL11
■ Titanio titanium	A	086BHM23AL12

MENSOLA PIANA ALLUMINIO L.1200 P.120 H.3 FLAT ALUMINUM SHELF L.1200 D.120 H.3

FINITURA Finish	A/V*	CODICE Code
■ Nero black	A	086BHM24AL11
■ Titanio titanium	A	086BHM24AL12

MENSOLA PIANA ALLUMINIO L.1500 P.120 H.3 FLAT ALUMINUM SHELF L.1500 D.120 H.3

FINITURA Finish	A/V*	CODICE Code
■ Nero black	A	086BHM25AL11
■ Titanio titanium	A	086BHM25AL12

*A/V: A=ANODIZZATO V=VERNICIATO
ANODIZED PAINTED

Accessori alluminio Aluminium accessories

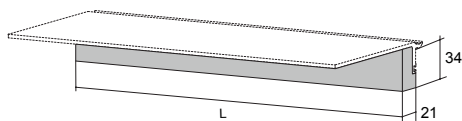

*N.B.: prima del montaggio forare il pannello per passaggio cavo.
Non inseribile con pannello in composito.*

Prolunga di 4 mt lineari

Note: before assembly, drill the panel for cable passage
Cannot be inserted with composite panel

Extension of 4 linear meters

PROFILO LUCE PER MENSOLA PROFILE LIGHT FOR SHELF

FINITURA Finish	Lunghezza Length	A/V*	CODICE Code
■ Nero black	L 30	A	086BHM70AL11
■ Titanio titanium	L 30	A	086BHM70AL12
■ Nero black	L 45	A	086BHM71AL11
■ Titanio titanium	L 45	A	086BHM71AL12
■ Nero black	L 60	A	086BHM72AL11
■ Titanio titanium	L 60	A	086BHM72AL12
■ Nero black	L 90	A	086BHM73AL11
■ Titanio titanium	L 90	A	086BHM73AL12
■ Nero black	L 120	A	086BHM74AL11
■ Titanio titanium	L 120	A	086BHM74AL12
■ Nero black	L 150	A	086BHM75AL11
■ Titanio titanium	L 150	A	086BHM75AL12

Accessori alluminio e legno Aluminium and wood accessories

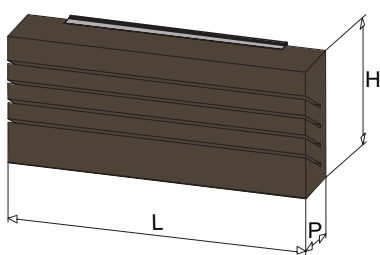

PORTACOLTELLI LEGNO SCURO + aggancio in finitura anodica L.300 P.60 H.130 KNIFE HOLDER IN DARK WOOD + anodic finish hook L.300 D.60 H.130

FINITURA Finish	A/V*	CODICE Code
■ ■ L. Scuro - Nero dark wood - black	A	086BHM12AL11
■ ■ L. Scuro - Titanio dark wood - titanium	A	086BHM12AL12

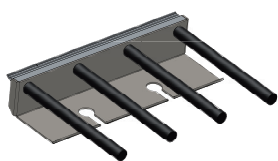

PORTABOTTIGLIE+CALICI L.267 P.193 H.43 BOTTLE+GLASS RACK L.267 D.193 H.43

FINITURA Finish	A/V*	CODICE Code
■ Nero black	A	086BHM14AL11
■ Titanio titanium	A	086BHM14AL12

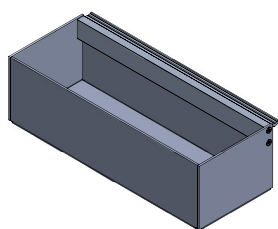

VASCHETTA PORTA PIANTINE L.285 P.110 H.85 SEEDLING TRAY L.285 D.110 H.85

FINITURA Finish	A/V*	CODICE Code
■ Nero black	A	086BHM47AL11
■ Titanio titanium	A	086BHM47AL12

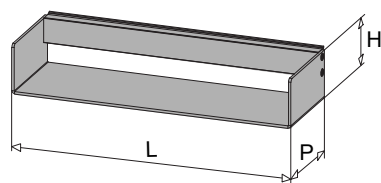

MENSOLA PORTAOGGETTI L.300 P.90 H.50 GLOVE SHELF L.300 D.90 H.50

FINITURA Finish	A/V*	CODICE Code
■ Nero black	A	086BHM40AL11
■ Titanio titanium	A	086BHM40AL12

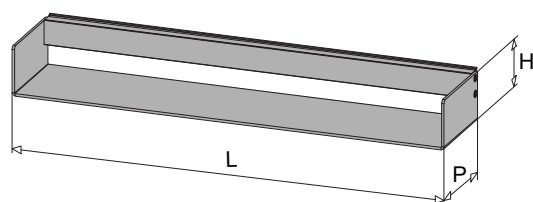

MENSOLA PORTAOGGETTI L.450 P.90 H.50 GLOVE SHELF L4500 D.90 H.50

FINITURA Finish	A/V*	CODICE Code
■ Nero black	A	086BHM41AL11
■ Titanio titanium	A	086BHM41AL12

*A/V: A=ANODIZZATO V=VERNICIATO
ANODIZED PAINTED

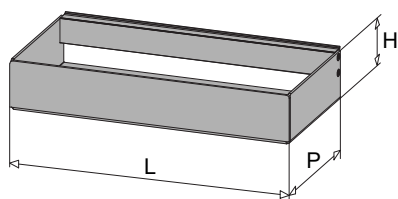

MENSOLA PORTAOGGETTI L.300 P.140 H.50
GLOVE SHELF L300 D.140 H.50

FINITURA Finish	A/V*	CODICE Code
■ Nero black	A	086BHM45AL11
■ Titanio titanium	A	086BHM45AL12

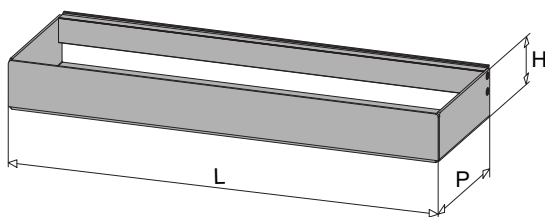

MENSOLA PORTAOGGETTI L.450 P.140 H.50
GLOVE SHELF L450 D.140 H.50

FINITURA Finish	A/V*	CODICE Code
■ Nero black	A	086BHM46AL11
■ Titanio titanium	A	086BHM46AL12

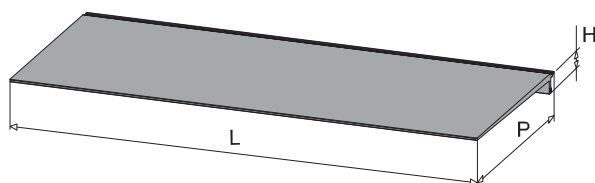

MENSOLA PIANA ALLUMINIO L.600 P.250 H.3
FLAT ALUMINUM SHELF L.600 D.250 H.3

FINITURA Finish	A/V*	CODICE Code
■ Nero black	A	086BHM32AL11
■ Titanio titanium	A	086BHM32AL12

SOLO PER COMPOSIZIONI LIVING
ONLY FOR LIVING COMPOSITIONS

NB: Nell'inserimento della mensola P 250, assicurarsi che il fissaggio dei pannelli a muro sia adeguato.

Note: When inserting the W 250 shelf, make sure the fixing of the panels to the wall is adequate.

MENSOLA PIANA ALLUMINIO L.900 P.250 H.3
FLAT ALUMINUM SHELF L.900 D.250 H.3

FINITURA Finish	A/V*	CODICE Code
■ Nero black	A	086BHM33AL11
■ Titanio titanium	A	086BHM33AL12

MENSOLA PIANA ALLUMINIO L.1200 P.250 H.3
FLAT ALUMINUM SHELF L.1200 D.250 H.3

FINITURA Finish	A/V*	CODICE Code
■ Nero black	A	086BHM34AL11
■ Titanio titanium	A	086BHM34AL12

MENSOLA PIANA ALLUMINIO L.1500 P.250 H.3
FLAT ALUMINUM SHELF L.1500 D.250 H.3

FINITURA Finish	A/V*	CODICE Code
■ Nero black	A	086BHM35AL11
■ Titanio titanium	A	086BHM35AL12

*A/V: A=ANODIZZATO V=VERNICIATO
ANODIZED PAINTED

PANNELLO SCHIENALE PER FUOCHI ALLUMINIO L.600 P.12 H.310
BACK PANEL FOR ALUMINUM FIREPLACE L.600 D.12 H.310

FINITURA Finish	A/V*	CODICE Code
■ Nero black	A	086BHM16AL11
■ Titanio titanium	A	086BHM16AL12

PANNELLO SCHIENALE PER FUOCHI ALLUMINIO L.600 P.12 H.340
BACK PANEL FOR ALUMINUM FIREPLACE L.600 D.12 H.340

FINITURA Finish	A/V*	CODICE Code
■ Nero black	A	086BHM50AL11
■ Titanio titanium	A	086BHM50AL12

PANNELLO SCHIENALE PER FUOCHI ALLUMINIO L.750 P.12 H.310
BACK PANEL FOR ALUMINUM FIREPLACE L.750 D.12 H.310

FINITURA Finish	A/V*	CODICE Code
■ Nero black	A	086BHM17AL11
■ Titanio titanium	A	086BHM17AL12

PANNELLO SCHIENALE PER FUOCHI ALLUMINIO L.750 P.12 H.340
BACK PANEL FOR ALUMINUM FIREPLACE L.750 D.12 H.340

FINITURA Finish	A/V*	CODICE Code
■ Nero black	A	086BHM51AL11
■ Titanio titanium	A	086BHM51AL12

PANNELLO SCHIENALE PER FUOCHI ALLUMINIO L.900 P.12 H.310
BACK PANEL FOR ALUMINUM FIREPLACE L.900 D.12 H.310

FINITURA Finish	A/V*	CODICE Code
■ Nero black	A	086BHM19AL11
■ Titanio titanium	A	086BHM19AL12

PANNELLO SCHIENALE PER FUOCHI ALLUMINIO L.900 P.12 H.340
BACK PANEL FOR ALUMINUM FIREPLACE L.900 D.12 H.340

FINITURA Finish	A/V*	CODICE Code
■ Nero black	A	086BHM53AL11
■ Titanio titanium	A	086BHM53AL12

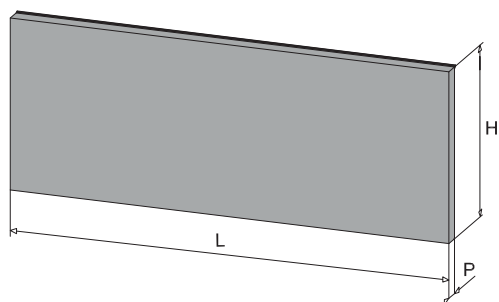

GANCIO DOPPIO
Double Hook

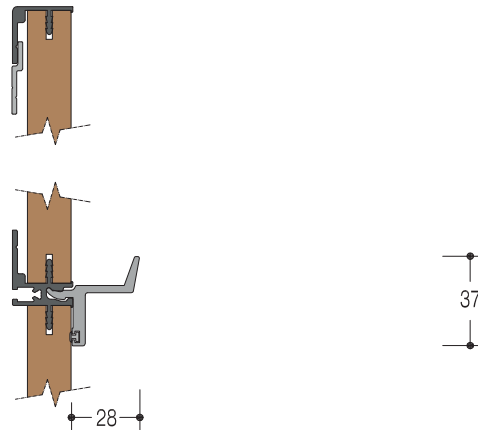

PORTAROTOLO
Roll Holder

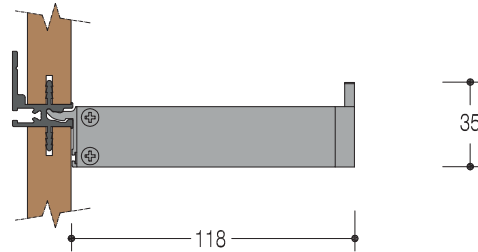

PORTAOGGETTI
Glove Holder

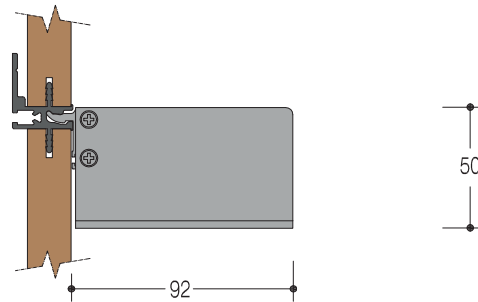

PORTACOLTELLI
Knife Holder

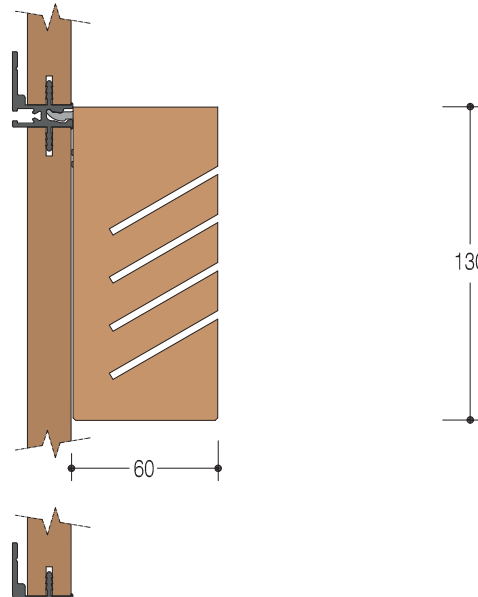

MENSOLA PROF. 130
Shelf Depth.130

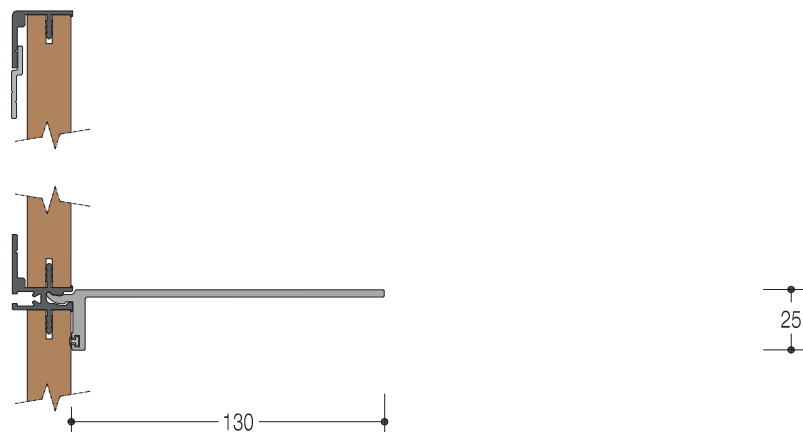

MENSOLA PROF. 250
Shelf Depth.250

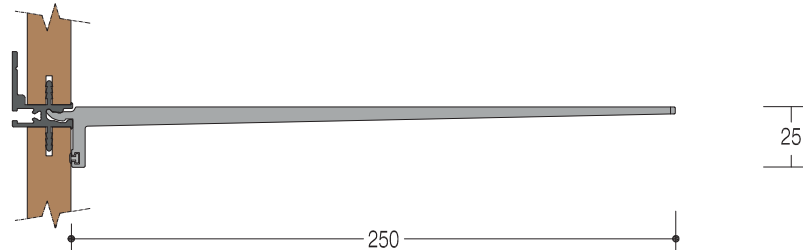

**PROFILO LED PER MENSOLA
PROF. 130/250**
Led Profile for Shelf Depth.130/250

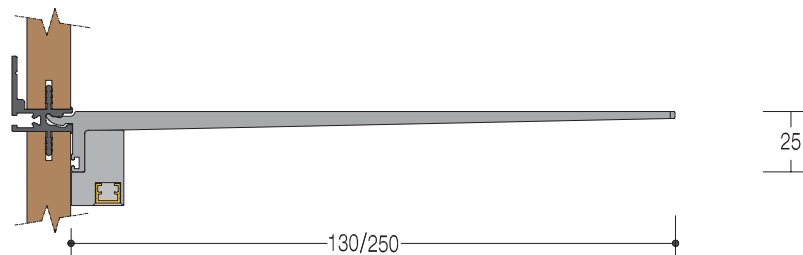

BOX ILLUMINAZIONE
Lighting Box

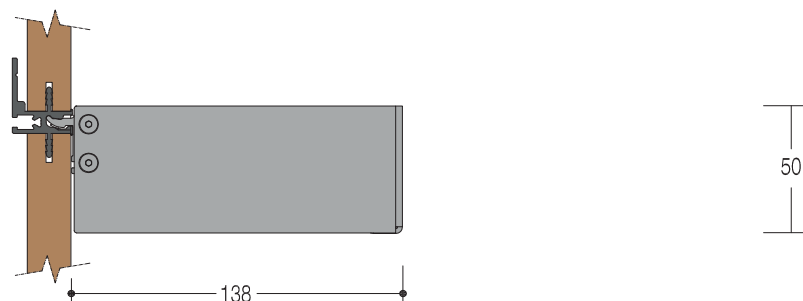

CATEGORIA PARETE WALL CATEGORY

Rappresentazione di soluzioni per rivestimento parete, in funzione degli allineamenti dei pensili della cucina di riferimento. Le quote sono puramente indicative e vanno adattate alla reale condizione reali di installazione (irregolarità della pavimentazione/regolazione dei piedi).

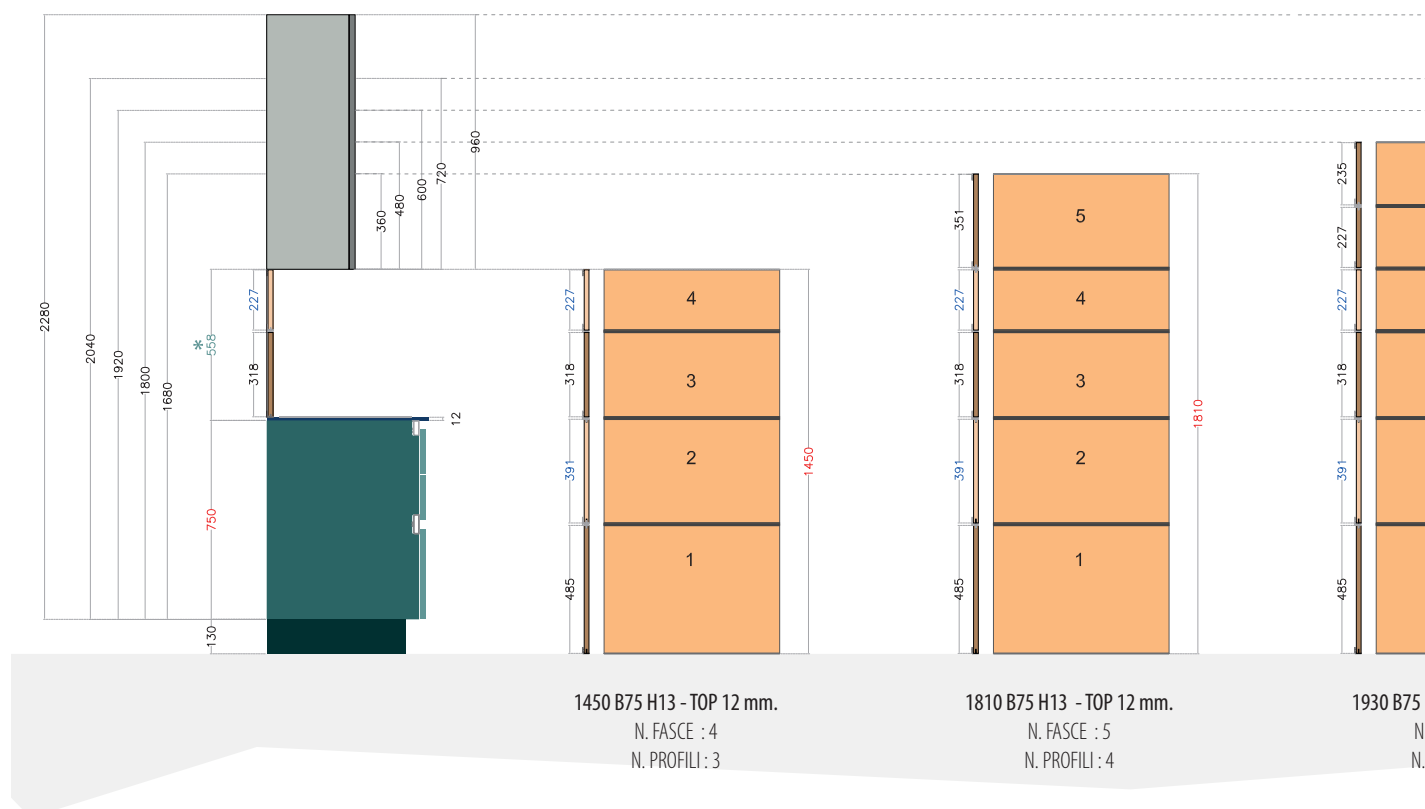

QUOTE JOLLY AD ALTEZZA VARIABILE

Le altezze indicate nelle fasce n. 2 e n.4 possono variare la loro altezza in relazione allo spessore del piano. Questo per mantenere sempre gli allineamenti per ogni tipologia di top.

Nel disegno presente nella parte superiore vengono riportati gli allineamenti considerando il top spessore 12 mm. Per le altre tipologie occorre considerare le seguenti differenze:

TOP H 20 = H + 8 mm per FASCIA 2
H - 8 mm per FASCIA 4

TOP H 22 = H + 10 mm per FASCIA 2
H - 10 mm per FASCIA 4

TOP H 30 = H + 18 mm per FASCIA 2
H - 18 mm per FASCIA 4

TOP H 40 = H + 28 mm per FASCIA 2
H - 28 mm per FASCIA 4

BASE H 75 bridge ZOCCOLO 13
BASE H 75 bridge PLINTH 13

Representation of solutions for wall covering, depending on the alignments of the reference kitchen wall units. The dimensions are purely indicative and should be adapted to the actual condition of installation (unevenness of flooring/footing adjustment).

- **QUOTE DI RIFERIMENTO**
REFERENCE QUOTE
- **QUOTE JOLLY (H VARIABILE)**
JOLLY QUOTE (H VARIABLE)
- **QUOTE FISSE**
FIXED DIMENSION
- **QUOTE H TRA BASE E PENSILE**
DIMENSIONS BETWEEN BASE AND CABINET

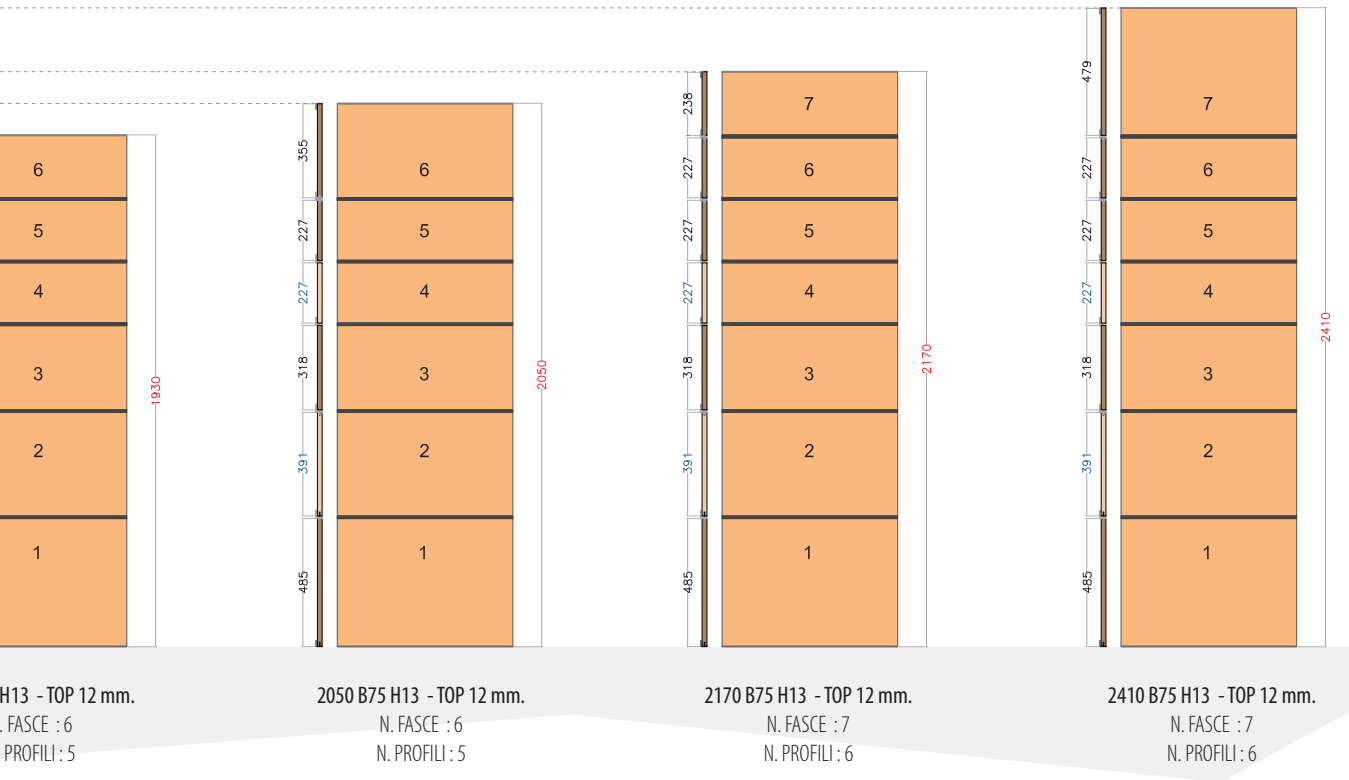

DIMENSIONS WITH VARIABLE HEIGHT

The heights indicated in the bands n. 2 and n.4 can change their height in relation to the top thickness. This solution it was designed for maintaining alignments for each type of top.

The drawings in the upper, consider the top with thick 12 mm. For the other types, must be considered the difference below:

TOP H 20 = H + 8 mm for band 2
H - 8 mm for band 4

TOP H 22 = H + 10 mm for band 2
H - 10 mm for band 4

TOP H 30 = H + 18 mm for band 2
H - 18 mm for band 4

TOP H 40 = H + 28 mm for band 2
H - 28 mm for band 4

CATEGORIA PARETE WALL CATEGORY

Rappresentazione di soluzioni per rivestimento parete, in funzione degli allineamenti dei pensili della cucina di riferimento. Le quote sono puramente indicative e vanno adattate alla reale condizione reali di installazione (irregolarità della pavimentazione/regolazione dei piedi).

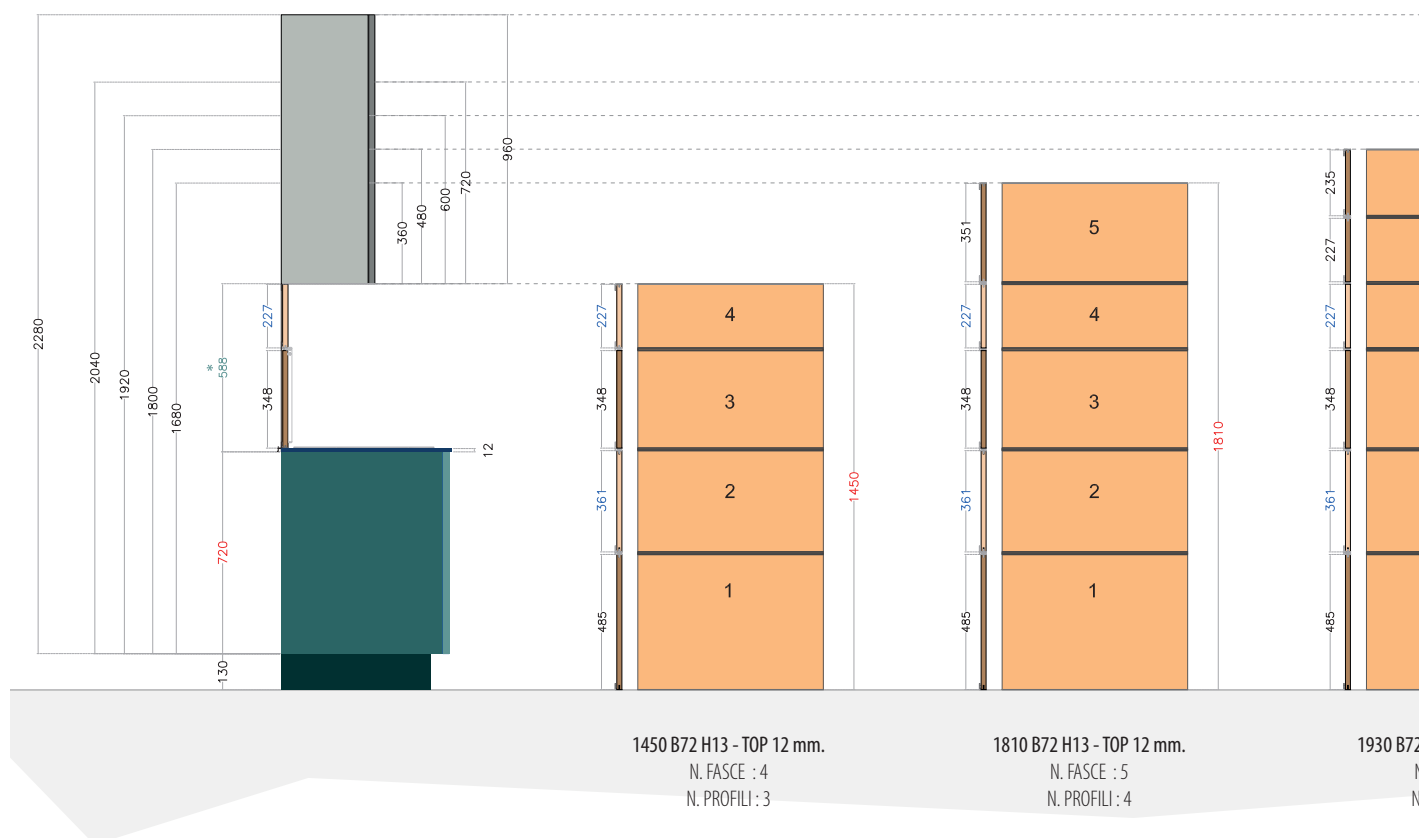

QUOTE JOLLY AD ALTEZZA VARIABILE

Le altezze indicate nelle fasce n. 2 e n.4 possono variare la loro altezza in relazione allo spessore del piano. Questo per mantenere sempre gli allineamenti per ogni tipologia di top.

Nel disegno presente nella parte superiore vengono riportati gli allineamenti considerando il top spessore 12 mm. Per le altre tipologie occorre considerare le seguenti differenze:

TOP H 20 = H + 8 mm per FASCIA 2
H - 8 mm per FASCIA 4

TOP H 22 = H + 10 mm per FASCIA 2
H - 10 mm per FASCIA 4

TOP H 30 = H + 18 mm per FASCIA 2
H - 18 mm per FASCIA 4

TOP H 40 = H + 28 mm per FASCIA 2
H - 28 mm per FASCIA 4

BASE H 72 neck ZOCCOLO 13
BASE H 72 neck PLINTH 13

Representation of solutions for wall covering, depending on the alignments of the reference kitchen wall units. The dimensions are purely indicative and should be adapted to the actual condition of installation (unevenness of flooring/footing adjustment).

- **QUOTE DI RIFERIMENTO**
REFERENCE QUOTE
- **QUOTE JOLLY (H VARIABILE)**
JOLLY QUOTE (H VARIABLE)
- **QUOTE FISSE**
FIXED DIMENSION
- **QUOTE H TRA BASE E PENSILE**
DIMENSIONS BETWEEN BASE AND CABINET

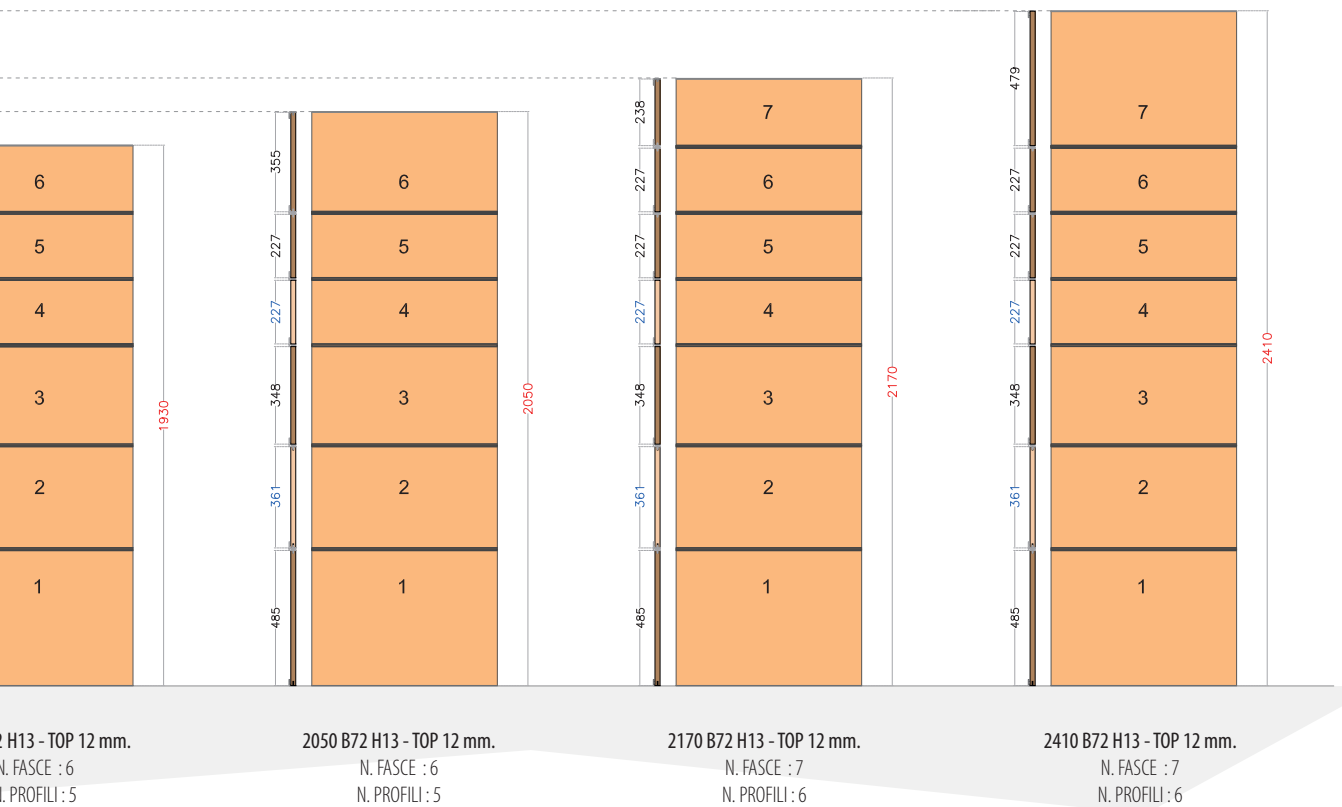

DIMENSIONS WITH VARIABLE HEIGHT

The heights indicated in the bands n. 2 and n. 4 can change their height in relation to the top thickness. This solution it was designed for maintaining alignments for each type of top.

The drawings in the upper, consider the top with thick 12 mm. For the other types, must be considered the difference below:

- TOP H 20** = H + 8 mm for band 2
H - 8 mm for band 4
- TOP H 22** = H + 10 mm for band 2
H - 10 mm for band 4
- TOP H 30** = H + 18 mm for band 2
H - 18 mm for band 4
- TOP H 40** = H + 28 mm for band 2
H - 28 mm for band 4

CATEGORIA PARETE WALL CATEGORY

Rappresentazione di soluzioni per rivestimento parete, in funzione degli allineamenti dei pensili della cucina di riferimento. Le quote sono puramente indicative e vanno adattate alla reale condizione reali di installazione (irregolarità della pavimentazione/regolazione dei piedi).

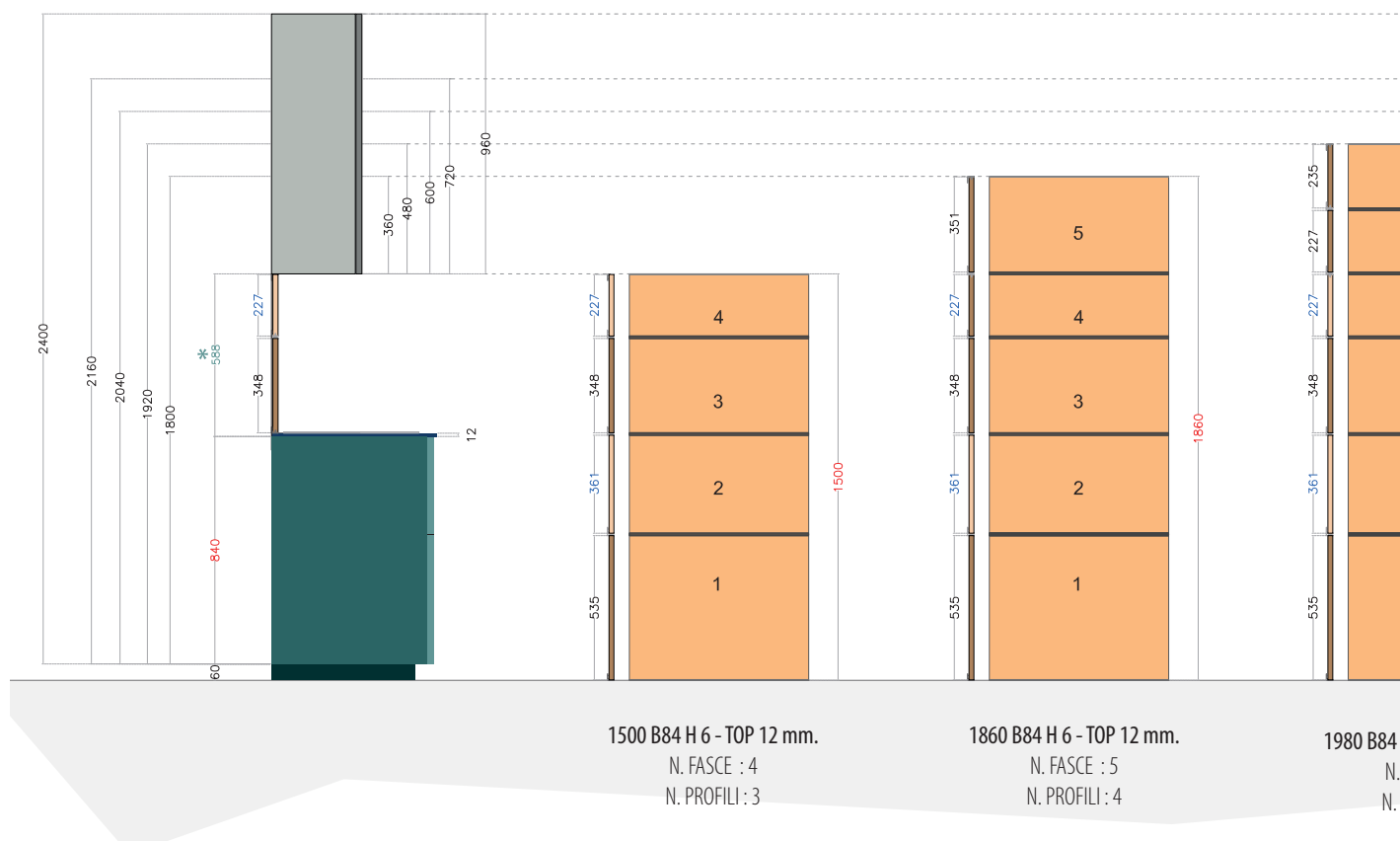

QUOTE JOLLY AD ALTEZZA VARIABILE

Le altezze indicate nelle fasce n. 2 e n.4 possono variare la loro altezza in relazione allo spessore del piano. Questo per mantenere sempre gli allineamenti per ogni tipologia di top.

Nel disegno presente nella parte superiore vengono riportati gli allineamenti considerando il top spessore 12 mm. Per le altre tipologie occorre considerare le seguenti differenze:

TOP H 20 = H + 8 mm per FASCIA 2
H - 8 mm per FASCIA 4

TOP H 22 = H + 10 mm per FASCIA 2
H - 10 mm per FASCIA 4

TOP H 30 = H + 18 mm per FASCIA 2
H - 18 mm per FASCIA 4

TOP H 40 = H + 28 mm per FASCIA 2
H - 28 mm per FASCIA 4

BASE H 84 bridge ZOCCOLO 13
BASE H 84 bridge PLINTH 13

Representation of solutions for wall covering, depending on the alignments of the reference kitchen wall units. The dimensions are purely indicative and should be adapted to the actual condition of installation (unevenness of flooring/footing adjustment).

- QUOTE DI RIFERIMENTO
REFERENCE QUOTE
- QUOTE JOLLY (H VARIABILE)
JOLLY QUOTE (H VARIABLE)
- QUOTE FISSE
FIXED DIMENSION
- QUOTE H TRA BASE E PENSILE
DIMENSIONS BETWEEN BASE AND CABINET

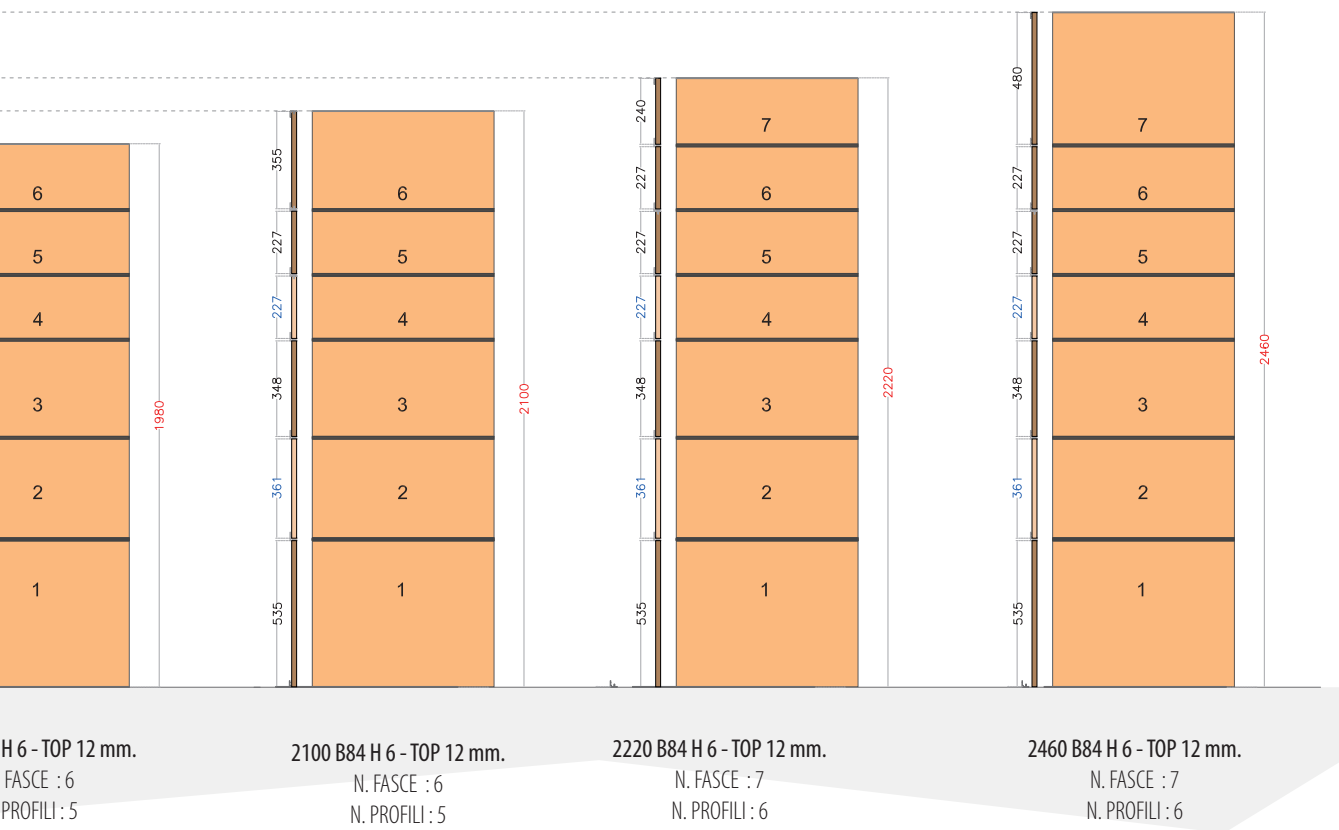

DIMENSIONS WITH VARIABLE HEIGHT

The heights indicated in the bands n. 2 and n.4 can change their height in relation to the top thickness. This solution it was designed for maintaining alignments for each type of top.

The drawings in the upper, consider the top with thick 12 mm. For the other types, must be considered the difference below:

- TOP H 20** = H + 8 mm for band 2
H - 8 mm for band 4
- TOP H 22** = H + 10 mm for band 2
H - 10 mm for band 4
- TOP H 30** = H + 18 mm for band 2
H - 18 mm for band 4
- TOP H 40** = H + 28 mm for band 2
H - 28 mm for band 4

CATEGORIA PARETE WALL CATEGORY

Rappresentazione di soluzioni per rivestimento parete, in funzione degli allineamenti dei pensili della cucina di riferimento. Le quote sono puramente indicative e vanno adattate alla reale condizione reali di installazione (irregolarità della pavimentazione/regolazione dei piedi).

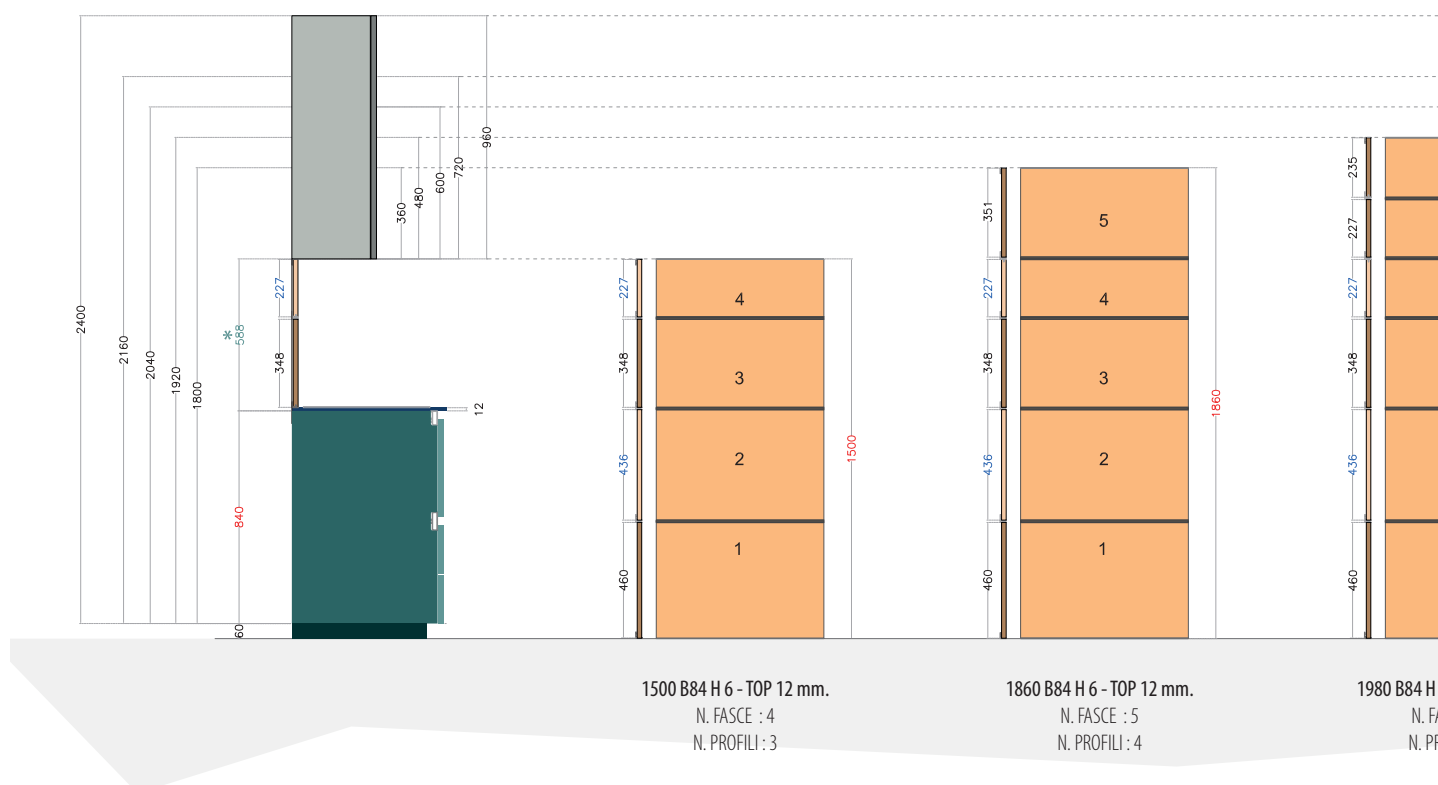

QUOTE JOLLY AD ALTEZZA VARIABILE

Le altezze indicate nelle fasce n. 2 e n.4 possono variare la loro altezza in relazione allo spessore del piano. Questo per mantenere sempre gli allineamenti per ogni tipologia di top.

Nel disegno presente nella parte superiore vengono riportati gli allineamenti considerando il top spessore 12 mm. Per le altre tipologie occorre considerare le seguenti differenze:

TOP H 20 = H + 8 mm per FASCIA 2
H - 8 mm per FASCIA 4

TOP H 22 = H + 10 mm per FASCIA 2
H - 10 mm per FASCIA 4

TOP H 30 = H + 18 mm per FASCIA 2
H - 18 mm per FASCIA 4

TOP H 40 = H + 28 mm per FASCIA 2
H - 28 mm per FASCIA 4

BASE H 84 neck ZOCCOLO 13
BASE H 84 neck PLINTH 13

Representation of solutions for wall covering, depending on the alignments of the reference kitchen wall units. The dimensions are purely indicative and should be adapted to the actual condition of installation (unevenness of flooring/footing adjustment).

- **QUOTE DI RIFERIMENTO**
REFERENCE QUOTE
- **QUOTE JOLLY (H VARIABLE)**
JOLLY QUOTE (H VARIABLE)
- **QUOTE FISSE**
FIXED DIMENSION
- **QUOTE H TRA BASE E PENSILE**
DIMENSIONS BETWEEN BASE AND CABINET

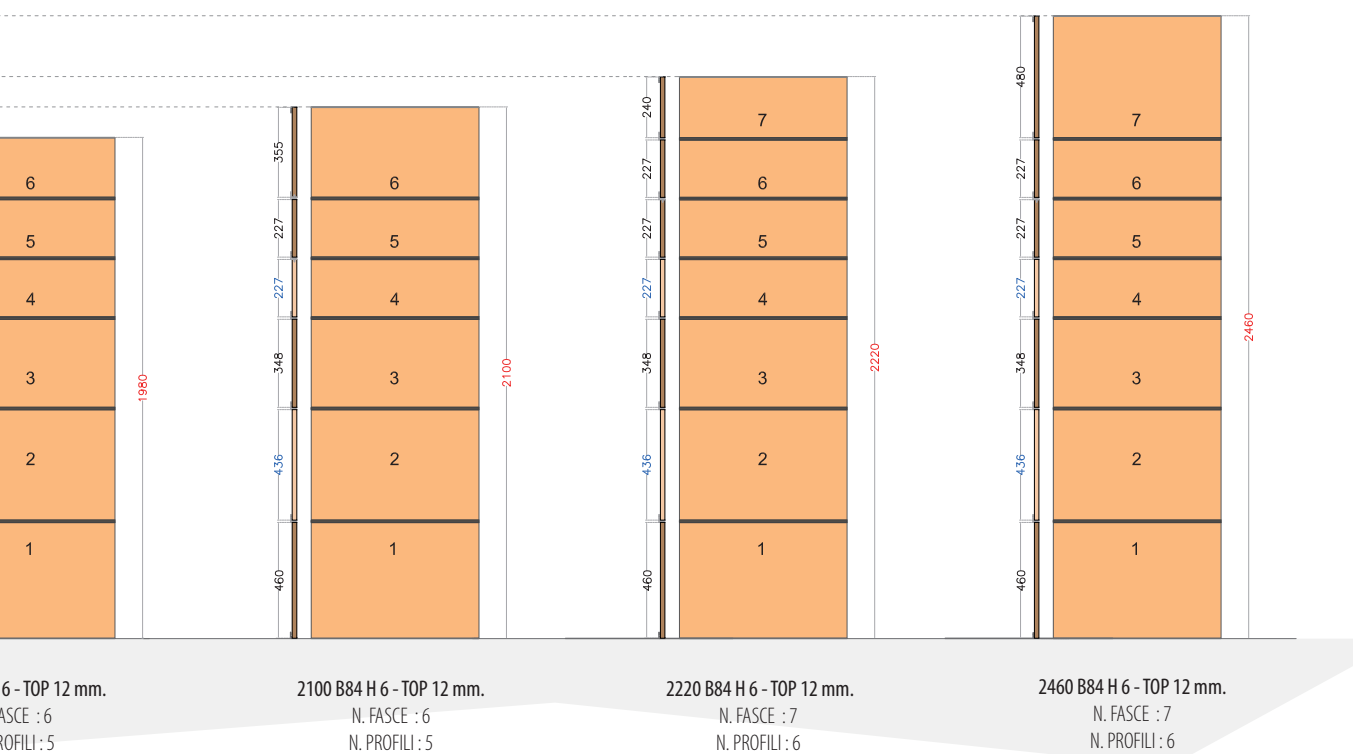

DIMENSIONS WITH VARIABLE HEIGHT

The heights indicated in the bands n. 2 and n.4 can change their height in relation to the top thickness. This solution it was designed for maintaining alignments for each type of top.

The drawings in the upper, consider the top with thick 12 mm. For the other types, must be considered the difference below:

TOP H 20 = H + 8 mm for band 2
H - 8 mm for band 4

TOP H 22 = H + 10 mm for band 2
H - 10 mm for band 4

TOP H 30 = H + 18 mm for band 2
H - 18 mm for band 4

TOP H 40 = H + 28 mm for band 2
H - 28 mm for band 4

LIVING LIVING AREA

La categoria living rappresenta la soluzione di massima personalizzazione. E' pensata per dare la possibilità di scegliere liberamente il numero di profili e di pannelli nella composizione.

The living category is the solution for the maximum customization. Its designed to give the possibility to choose the composition, freely, both the number of profiles and panels.

ESPLOSO COMPONENTI PER COMPOSIZIONE LIVING - BLOWN-UP COMPONENTS FOR LIVING COMPOSITION

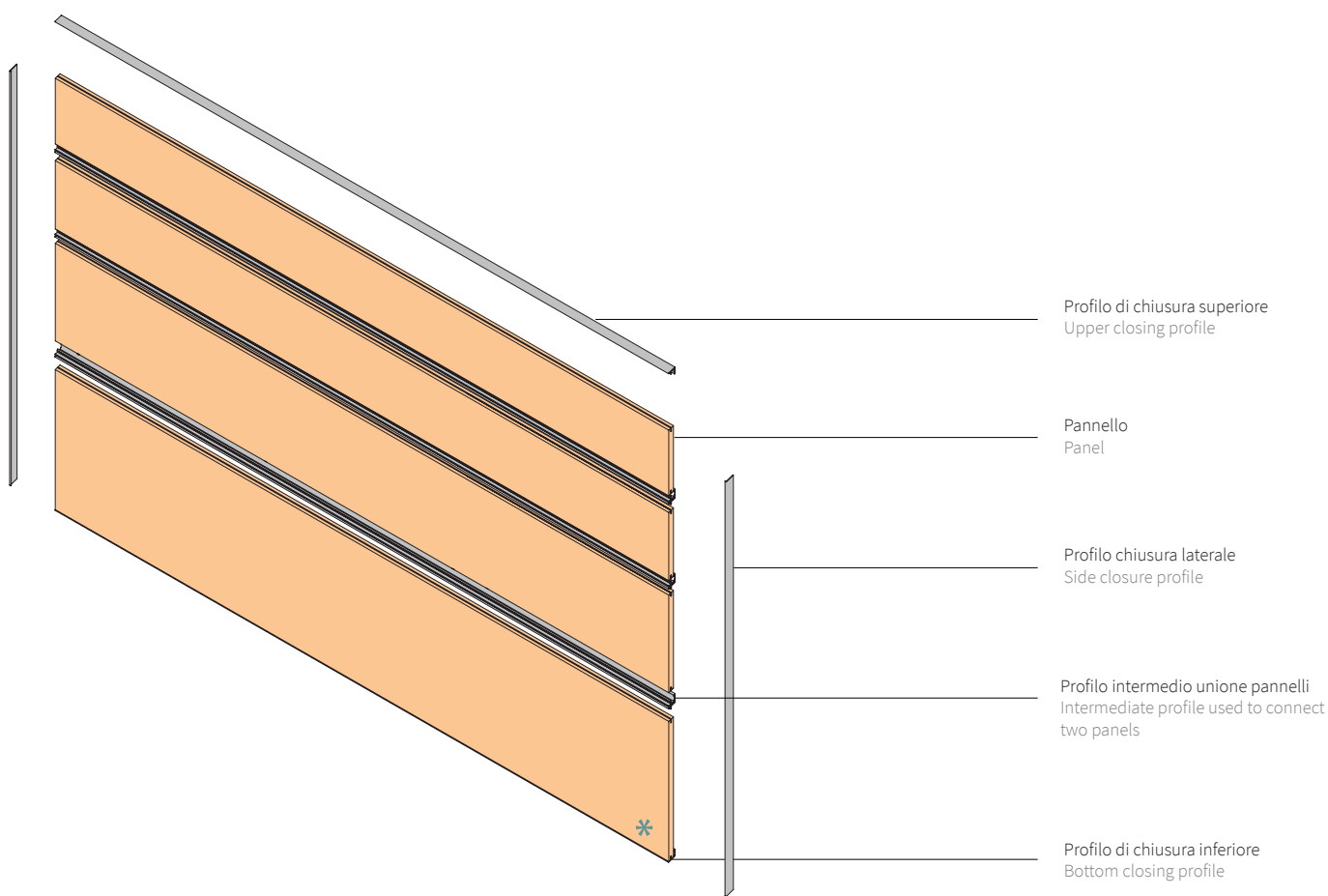

*
Opzione pannello inferiore in GRES, QUARZO o HPL solo per categoria CUCINA
Option bottom panel in STONEWARE ,QUARTZ or HPL is available only for KITCHEN category

FINITURE PANNELLI - PANEL FINISHES

Le finiture dei pannelli possono essere delle seguenti categorie:
MELAMINICO - LAMINATO - LACCATO UV - FENIX - WOOD - MATHERA - IMPIALLACCIATO

The panel finishes can be made in the categories below:
MELAMINE - LAMINATE - UV LACQUERED - FENIX - WOOD - MATHERA - VENEERED

Finiture Alluminio
Aluminum Finishes

Nero
Anodizzato
Black
anodized



Titanio
Anodizzato
Titanium
anodized



Finiture Legno
Wood Finishes

Legno
Scuro
Wood
dark

