

GRUPPOLUBE



TIEKO

2025

GRUPPO **LUBE**

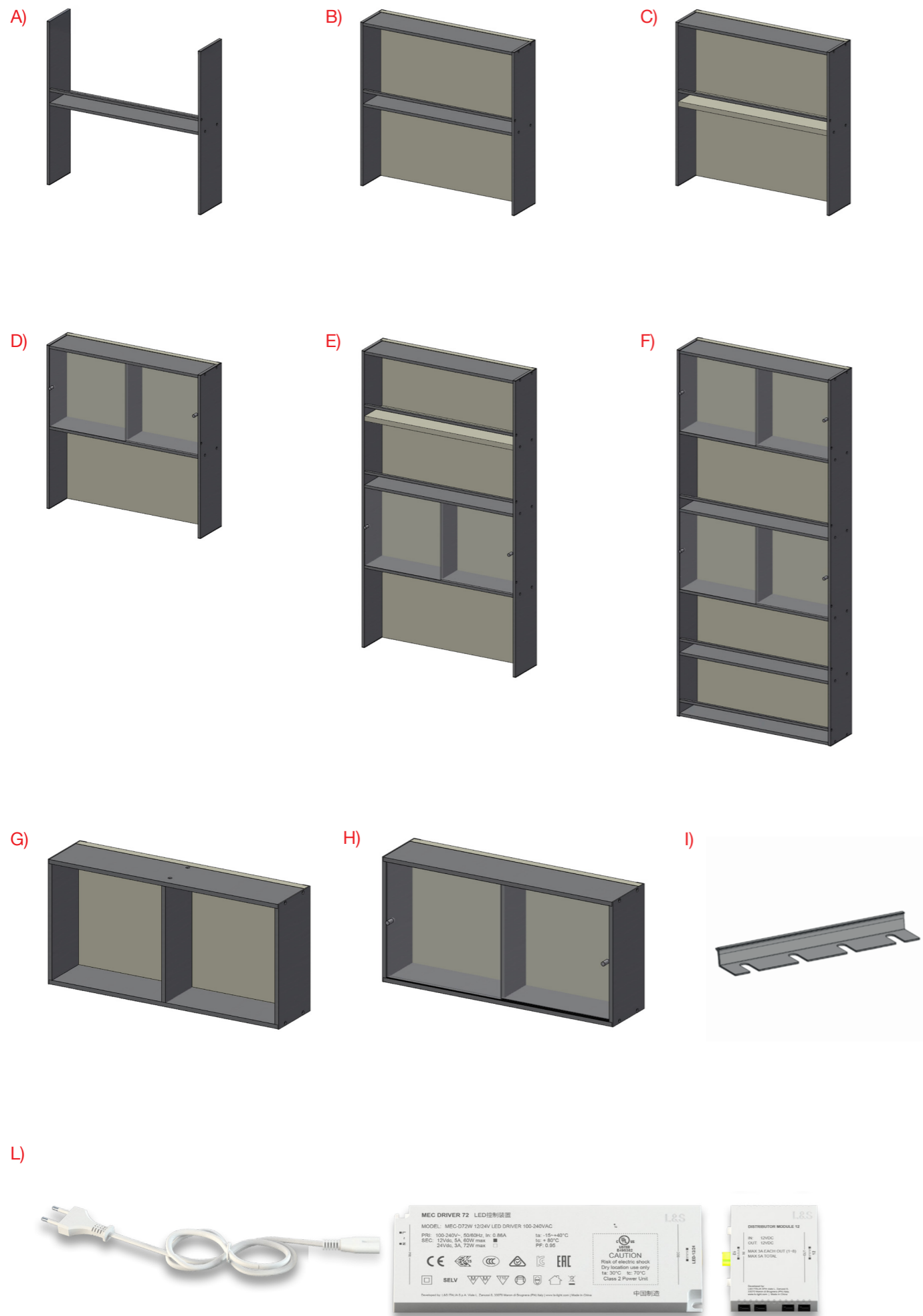

# INDICE

FINITURE FINISHES	pag.6
<b>A)</b> TIEKO STRUTTURA E RIPIANI IN ALLUMINIO SENZA SCHIENA	pag.44
<b>A)</b> TIEKO ALUMINIUM STRUCTURE AND SHELVES WITHOUT BACK PANEL	
<b>B)</b> TIEKO STRUTTURA E RIPIANI IN ALLUMINIO, SCHIENA NELLE FINITURE	
INSERITE A LISTINO CON O SENZA LUCI	pag.56
<b>B)</b> TIEKO ALUMINIUM STRUCTURE AND SHELVES, BACK PANEL IN THE FINISHES INCLUDED IN THE PRICE LIST WITH OR WITHOUT LIGHTS	
<b>C)</b> TIEKO STRUTTURA IN ALLUMINIO, SCHIENA E RIPIANI LEGNO NELLE FINITURE	
INSERITE A LISTINO CON O SENZA LUCI	pag.72
<b>C)</b> TIEKO ALUMINIUM STRUCTURE, BACK PANEL AND WOODEN SHELVES IN THE FINISHES INCLUDED IN THE PRICE LIST WITH OR WITHOUT LIGHTS	
<b>D)</b> TIEKO CON VETRINA ANTE SCORREVOLI STRUTTURA IN ALLUMINIO, RIPIANI IN ALLUMINIO	
SCHIENA NELLE FINITURE INSERITE A LISTINO CON O SENZA LUCI	pag.88
<b>D)</b> TIEKO WITH DISPLAY CABINET SLIDING DOORS ALUMINUM STRUCTURE, ALUMINUM SHELVES	
BACK PANEL IN THE FINISHES INCLUDED IN THE PRICE LIST WITH OR WITHOUT LIGHTS	
<b>E)</b> TIEKO CON VETRINA ANTE SCORREVOLI STRUTTURA IN ALLUMINIO, SCHIENA E RIPIANI LEGNO NELLE FINITURE	
INSERITE A LISTINO CON O SENZA LUCI	pag.104
<b>E)</b> TIEKO WITH DISPLAY CABINET SLIDING DOORS ALUMINUM STRUCTURE, BACK PANEL AND SHELVES	
WOOD IN THE FINISHES INCLUDED IN THE PRICE LIST WITH OR WITHOUT LIGHTS	
<b>F)</b> TIEKO CON DOPPIA VETRINA ANTE SCORREVOLI STRUTTURA E RIPIANI ALLUMINIO/LEGNO	
SCHIENA NELLE FINITURE INSERITE A LISTINO CON O SENZA LUCI	pag.116
<b>F)</b> TIEKO WITH DOUBLE GLASS CABINET SLIDING DOORS ALUMINUM/WOODEN STRUCTURE AND SHELVES, BACK PANEL IN THE FINISHES INCLUDED IN THE PRICE LIST WITH OR WITHOUT LIGHTS	
<b>G)</b> TIEKO SOTTOPENSILE H 30 CON SCHIENA NELLE FINITURE	
INSERITE A LISTINO	pag.123
SENZA LUCI	
<b>G)</b> TIEKO UNDER-CABINET H 30 WITH BACK PANEL IN THE FINISHES INCLUDED IN THE PRICE LIST WITHOUT LIGHTS	
<b>H)</b> TIEKO SOTTOPENSILE H 30 CON VETRINA E SCHIENA NELLE FINITURE	
INSERITE A LISTINO CON O SENZA LUCI	pag.125
<b>H)</b> TIEKO UNDER CABINET H 30 WITH DISPLAY CASE AND BACK PANEL IN THE FINISHES INCLUDED IN THE PRICE LIST WITH OR WITHOUT LIGHTS	
<b>I)</b> ACCESSORI	pag.126
<b>I)</b> ACCESSORIES	
<b>L)</b> ACCESSORI PER LUCI	pag.128
<b>L)</b> ACCESSORIES FOR LIGHT	
<b>M)</b> SCHEMA MONTAGGIO LUCI	pag.132
<b>M)</b> LIGHT ASSEMBLY DIAGRAM	

## Funzionalità ed estetica.

Disponibili in diverse finiture e design, i nostri accessori sono la soluzione ideale per valorizzare e completare la tua composizione in cucina.

## Functionality and aesthetics.

Available in different finishes and designs, our accessories are the ideal solution to enhance and complete your kitchen composition.

# STRUTTURA ALLUMINIO

ALUMINUM STRUCTURE

## COLORI DISPONIBILI

AVAILABLE COLOURS

---

NERO VERNICIATO OPZ. NV



RAME BRUNITO VERNICIATO OPZ. RBV



TITANIO VERNICIATO OPZ. TV



OTTONE VERNICIATO OPZ. OV



UMBER VERNICIATO OPZ. UV



# VETRI SCORREVOLI

SLIDING GLASSES

## COLORI DISPONIBILI

AVAILABLE COLOURS

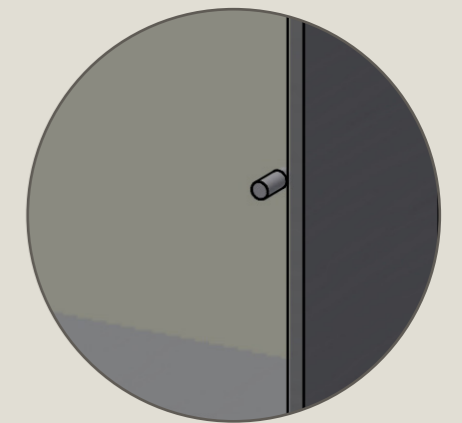

PARTICOLARE POMELLO VETRINA  
DETAIL OF THE SHOWCASE KNOB

## FINITURA TRASPARENTE

FINISH TRANSPARENT

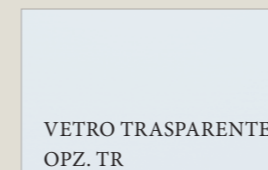

VETRO TRASPARENTE  
OPZ. TR

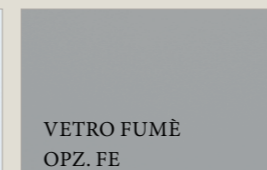

VETRO FUMÈ  
OPZ. FE



VETRO BRONZO  
OPZ. BZ

## FINITURA SATINATA CANNETTATA

FINISH SATIN REEDED



VETRO SATINATO  
BIANCO OPZ. BNC

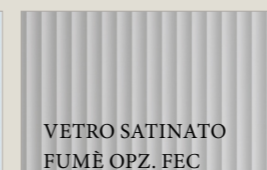

VETRO SATINATO  
FUMÈ OPZ. FEC



VETRO SATINATO  
BRONZO OPZ. BZC



VETRO SATINATO  
RAME BRUNITO OPZ. RBC

# LACCATO

LACQUERED

**N.B.: laccato opaco e super opaco  
disponibile per schienali e ripiani.  
Laccato uv solo per gli schienali, non  
disponibile per i ripiani.**

Note: matt and super matt lacquer  
available for back panel and shelves.

UV lacquer only for back panel, not  
available for shelves.

# COLORI DISPONIBILI

AVAILABLE COLOURS



# FINITURA LACCATO OPACO

MATT LACQUERED FINISH

BIANCO ASSOLUTO OPZ. 740S	BIANCO CALDO OPZ. 7401	LINO OPZ. 9513	CONCHIGLIA OPZ. 7403	TORTORA OPZ. 8993
CENERE OPZ. 9547	GRIGIO TRAFFICO OPZ. 9511	ARGILLA OPZ. 9503	GRIGIO REALE OPZ. 95F3	FUMO OPZ. 9531
GRIGIO QUARZO OPZ. 95F7	CUOIO OPZ. 8897	CARRUBA OPZ. 89L1	GRIGIO PIOMBO OPZ. 9537	GRIGIO LAVA OPZ. 95F1
GRIGIO BROMO OPZ. 9533	BLU CRISTAL OPZ. 8381	BISTRO OPZ. 9535	NERO SEPPIA OPZ. 7897	NERO OPZ. 7892
PLATINO OPZ. 7773	GRIGIO KENYA OPZ. 9501	CRETA OPZ. 9515	NOCCIOLA OPZ. 7775	GIALLO ZAFFERANO OPZ. 8253
GIALLO DIGIONE OPZ. 8257	CANNELLA OPZ. 8893	COTTO OPZ. 8887	ROSSO PERSIA OPZ. 8165	GRANATO OPZ. 8633
ROSSO OPZ. 125S	AZZURRO NUBE OPZ. 8379	AZZURRO OTTANIO OPZ. 8385	VERDE CELADON OPZ. 8485	VERDE BORNEO OPZ. 8483
VERDE CINABRO OPZ. 8481				

# FINITURA LACCATO SUPER OPACO

SUPER MATT LACQUERED FINISH

BIANCO ARTICO OPZ. E002	BIANCO 9010 OPZ. E010	BISCOTTO OPZ. E021	SILICIO OPZ. E081	FOSSILE OPZ. E751
TARTUFO OPZ. E651	GRIGIO ISLANDA OPZ. E121	GRIGIO LUNA OPZ. E122	GRIGIO ETNA OPZ. E124	NERO OPZ. E101
VERDE CARAIBI OPZ. E551	VERDE KITAMI OPZ. E552	VERDE AGAVE OPZ. E553	GIALLO AUTUNNO OPZ. E301	GIALLO EVORA OPZ. E302
ROSA CASALE OPZ. E251	PAPRIKA OPZ. E271	ROSSO FIAMMA OPZ. E201	BLU DENIM OPZ. E401	BLU SHABA OPZ. E402
GRIGIO NETTUNO OPZ. E123				

# FINITURA LACCATO UV OPACO *immagina*

MATT UV LACQUERED FINISH

BIANCO OPACO OPZ. 7405	BIANCO NEVE OPACO OPZ. 7407	DESERT OPACO OPZ. 8941	POLVERE OPACO OPZ. 9529
BEIGE COLORADO OPACO OPZ. 7777	GIALLO CADMIO OPACO OPZ. 8255	ROSSO CAMMEO OPACO OPZ. 8160	ROSSO VELVET OPACO OPZ. 8168
GRIGIO MINERALE OPACO OPZ. 9523	BLU COBALTO OPACO OPZ. 8383	VERDE MALGA OPACO OPZ. 8477	VERDE NILO OPACO OPZ. 8475
ANTRACITE OPACO OPZ. 9558	NERO OPACO OPZ. 7895		



# MELAMINICO

MELAMINE

**N.B.: per le finiture effetto legno le venature degli schienali sono sempre in senso verticale, mentre per i ripiani in senso orizzontale.**

**Note: for wood-effect finishes the grain of the back panels is always vertical, while for the shelves it is horizontal.**

# COLORI DISPONIBILI

AVAILABLE COLOURS

Per le finiture disponibili vedere le texture presenti nei seguenti listini dei modelli.  
For available finishes see the textures in the model pricelists.



#### IMMAGINA

Disponibili tutte le finiture melaminiche

N.B.: finiture pet disponibili solo per schienale non per i ripiani

All Melamine finishes available.

Note: pet finishes available only for backrest not for shelves



#### READY

Disponibili tutte le finiture melaminiche

All Melamine finishes available.



#### TABLET

Disponibili tutte le finiture melaminiche

All Melamine finishes available.



#### SMART

Disponibili tutte le finiture melaminiche

All Melamine finishes available.



#### UNICA

Disponibili tutte le finiture melaminiche

All Melamine finishes available.

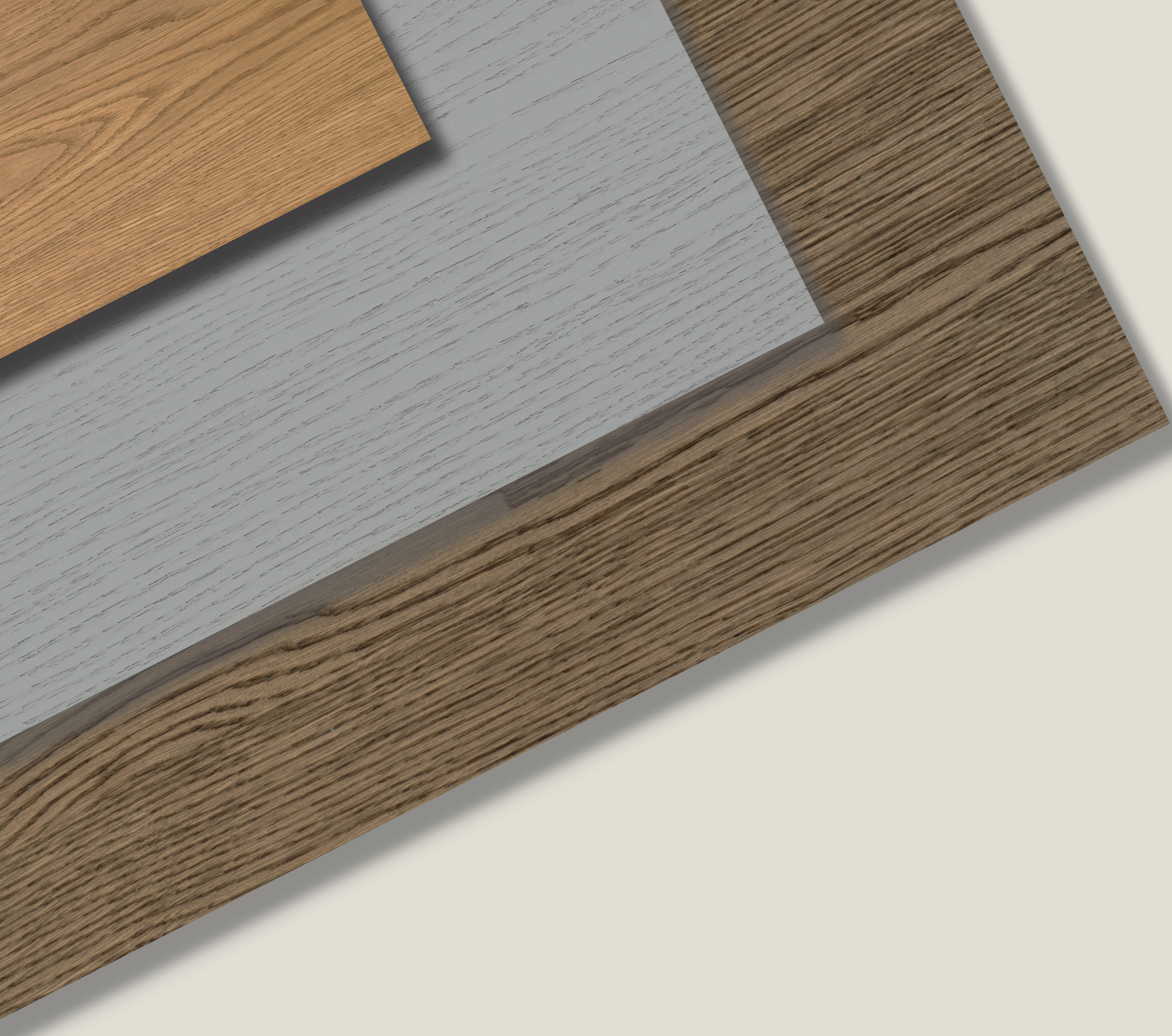

# IMPIALLACCIATO

VENEERED

**N.B.: disponibile per schienali e ripiani.  
Versione WOOD disponibili solo per schienali, no ripiani.  
Per gli schienali le venature sono sempre in senso verticale,  
mentre per i ripiani in senso orizzontale**

Note: available for backrests and shelves.

WOOD version available only for back panel, no shelves.

For the back panels the grain is always vertical,  
while for the shelves it is horizontal

## COLORI DISPONIBILI

AVAILABLE COLOURS

Per le finiture impiallacciate disponibili vedere le texture presenti nei seguenti listini dei modelli.  
For available veneered finishes see the textures in the model pricelists.



#### IMMAGINA WOOD

Disponibili tutte le finiture Wood.  
All Wood finishes available.

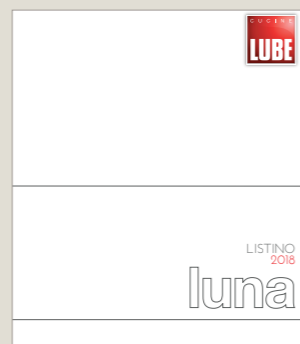

#### LUNA FASCIA "A"

Disponibili tutte le finiture impiallacciate.  
All veneered finishes available.



#### OLTRE FASCIA "A"

Disponibili tutte le finiture impiallacciate.  
All veneered finishes available.

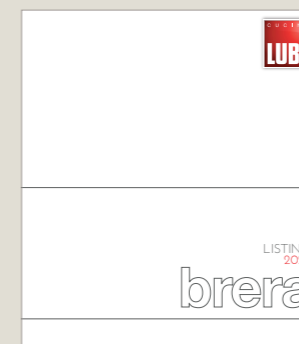

#### BRERA FASCIA "A" finiture rovere - FASCIA "B" finiture eucalipto e paulovnia

Disponibili tutte le finiture impiallacciate.  
All veneered finishes available.



#### CLOVER FASCIA "A"

Disponibili tutte le finiture impiallacciate.  
All veneered finishes available.

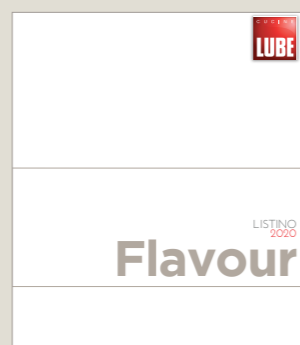

#### FLAVOUR FASCIA "A"

Disponibili tutte le finiture impiallacciate.  
All veneered finishes available.



#### TABLET WOOD

Disponibili tutte le finiture impiallacciate.  
All veneered finishes available.

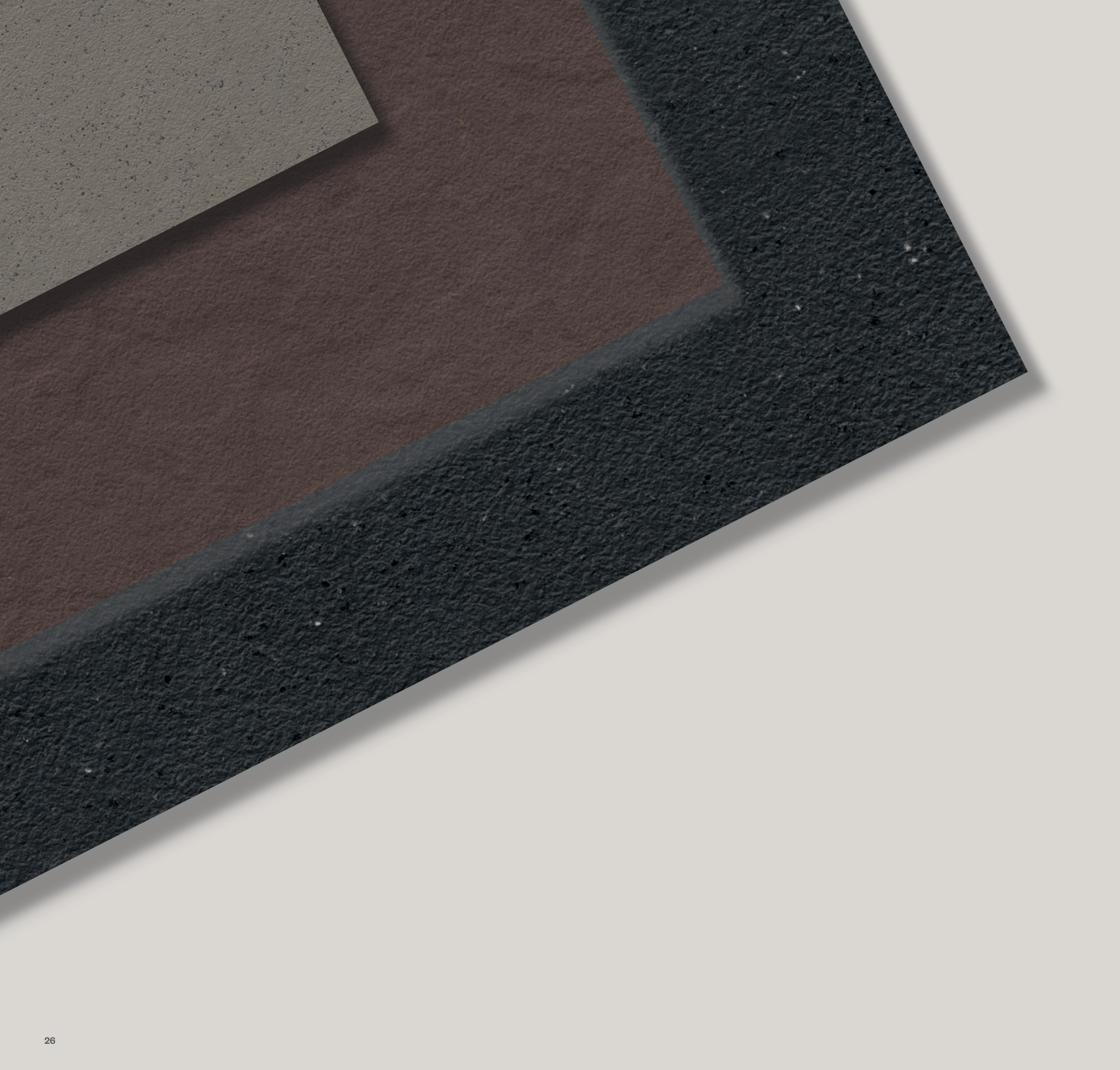

# MATHERA-PET IMMAGINA

**N.B.: solo per schienali, non disponibile per ripani.**  
Note: only for backrests, not available for shelves.

**COLORI**  
DISPONIBILI  
AVAILABLE COLOURS

# MATHERA

---

AREJA BEIGE OPZ. MT02



AREJA GRIGIO OPZ. MT03



AREJA NERO OPZ. MT04

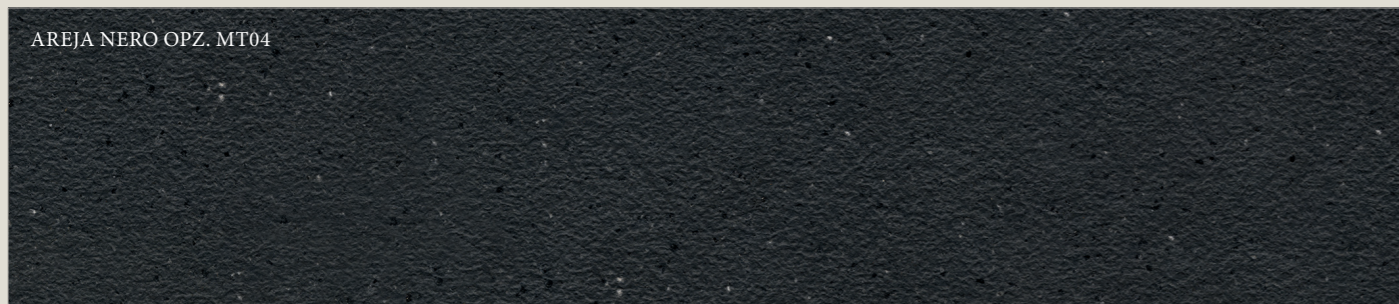

GIPSO GRIGIO OPZ. MT23

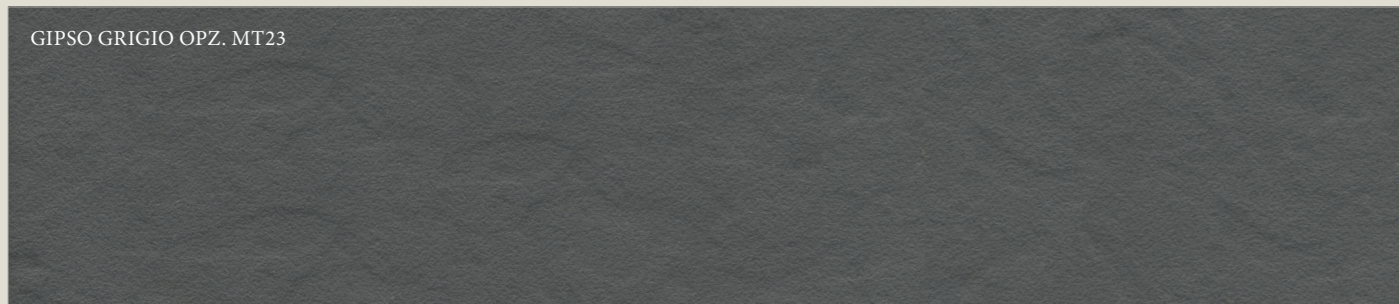

GIPSO ROSSO OPZ. MT24



GIPSO VERDE OPZ. MT22



SELCE GRIGIO CHIARO OPZ. MT13



SELCE NERO OPZ. MT14



# PET

---

PET METAL BRASS OPZ. 8848

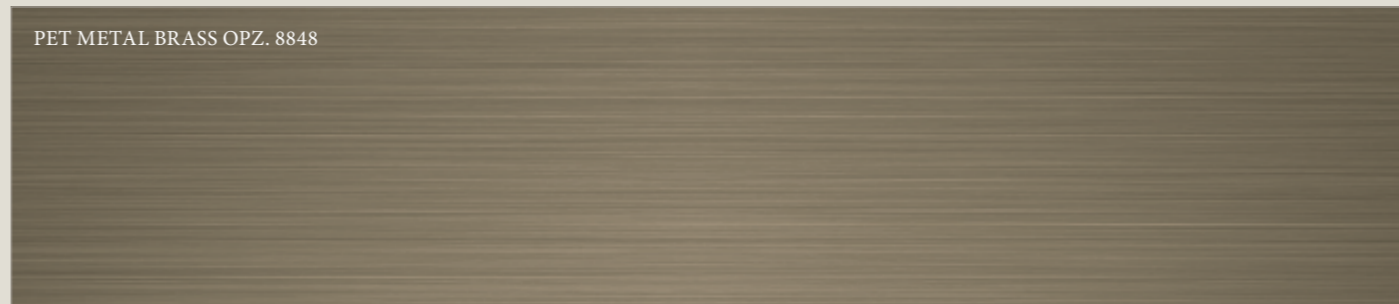

PET METAL BROWN OPZ. 8849

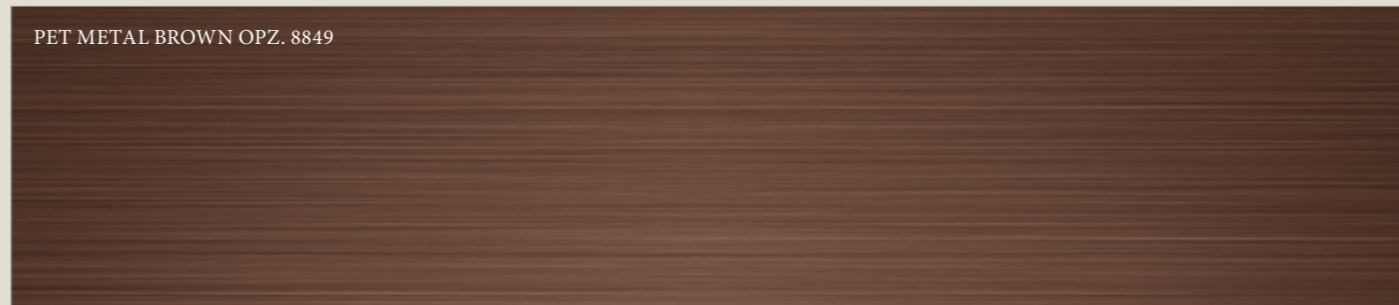

PET METAL DARK NIGHT OPZ. 7871

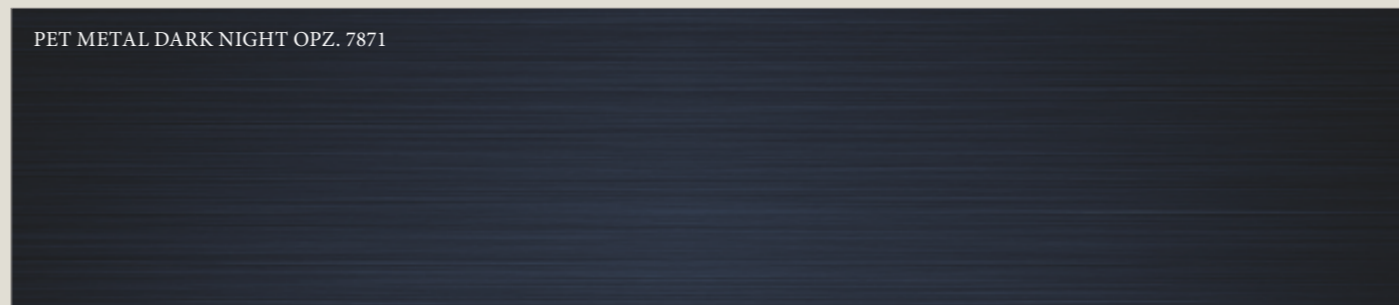





# FINITURE COME TOP

FINISHES WORKTOP

**N.B.: solo per schienali, non disponibile per ripani.  
Per le finiture effetto marmo e effetto legno  
la venatura è sempre in senso verticale**

**Note: only for backrests, not available for shelves.  
For marble effect and wood effect finishes  
the grain is always vertical**

LAMINATO LAMINATE

**COLORI**  
**DISPONIBILI**  
AVAILABLE COLOURS

# FINITURA EFFETTO MATERICO

TEXTURED EFFECT FINISH

MALTA VISIONE VINTAGE FINITURA PLAMKY OPZ. 5568



LUSERNA FINITURA LUNA OPZ. 3366



FERRO FINITURA OSSIDATA OPZ. L933



PELTRO FINITURA OSSIDATA OPZ. L934

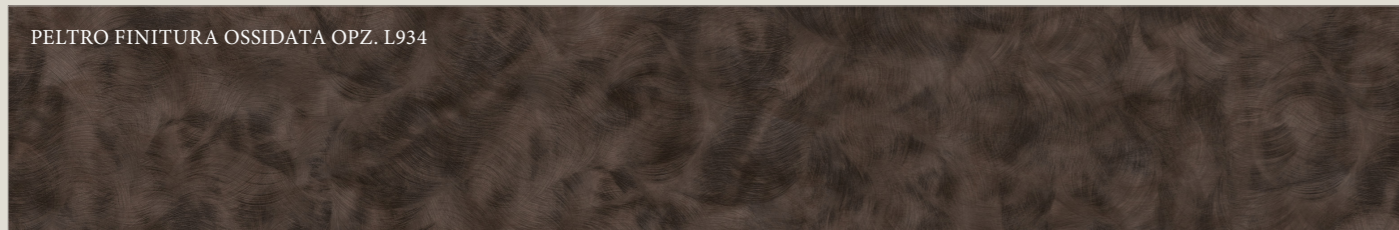

BIANCO ALPINO FINITURA TOUCH OPZ. 309C

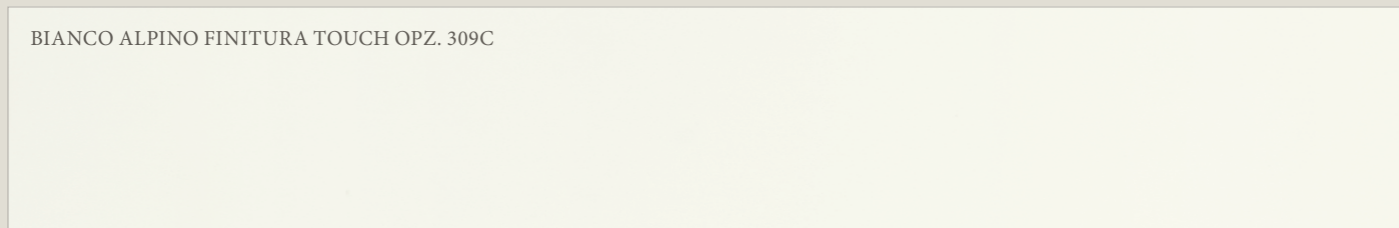

OLD WHITE FINITURA URBAN OPZ. LM11

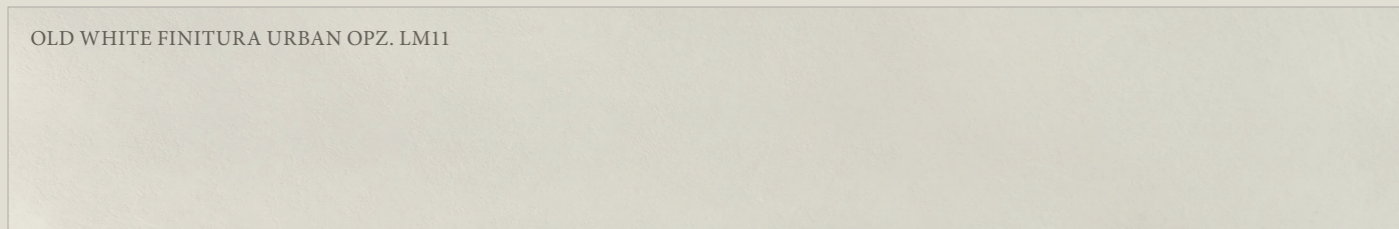

OLD GREY FINITURA URBAN OPZ. LM12



OLD DARK FINITURA URBAN OPZ. LM13



OLD BLACK FINITURA URBAN OPZ. LM14

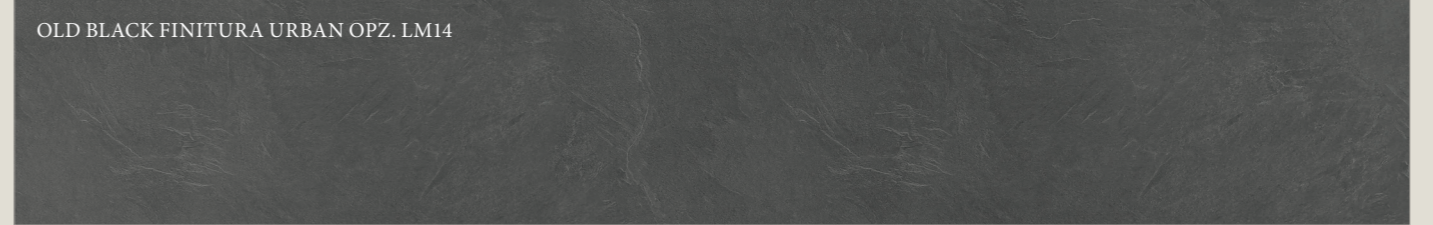

BRASS FINITURA FLASH OPZ. 5025

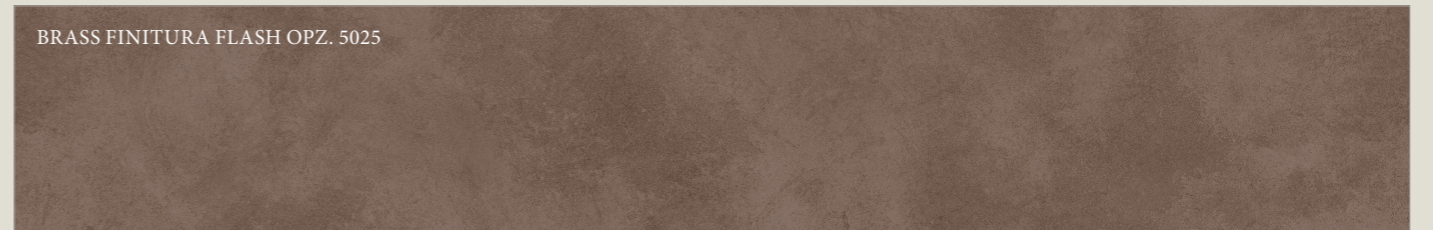

IRON FINITURA TOUCH OPZ. 2765



STONE CLOUDY FINITURA REAL OPZ. SH10



# FINITURA EFFETTO MARMO

MARBLE-EFFECT FINISH

BIANCO LASA FINITURA MN OPZ. 6152

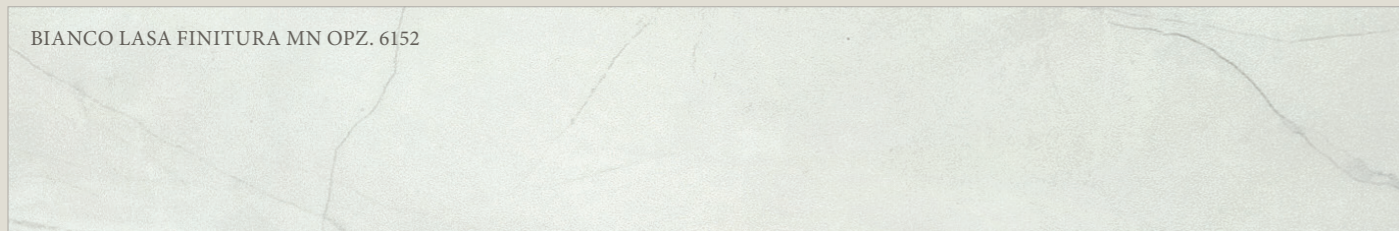

DARK FINITURA MN OPZ. 6133



IMPERIAL BLACK FINITURA KER OPZ. 3452

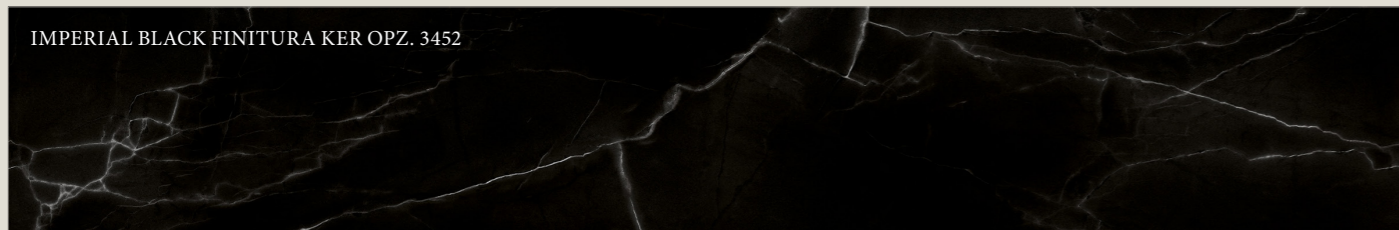

CALACATTA FINITURA MN OPZ. 6019

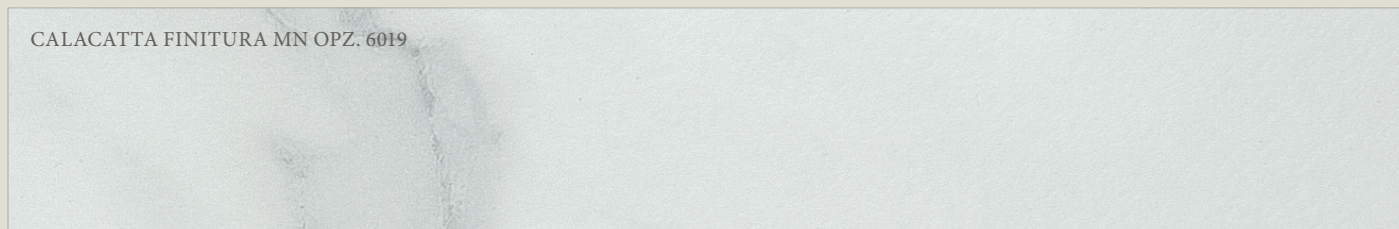

MARMO NUVOLATO FINITURA PLAMKY OPZ. 6074



MARMO ELITE FINITURA KER OPZ. 3476

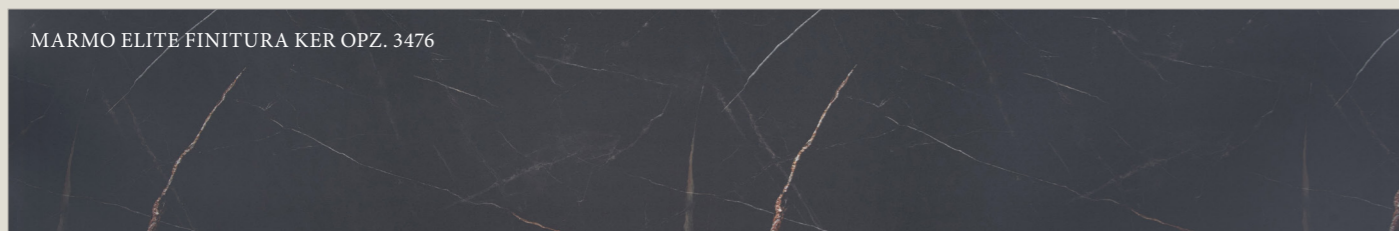

KASPIO ORO FINITURA FLASH OPZ. 6089

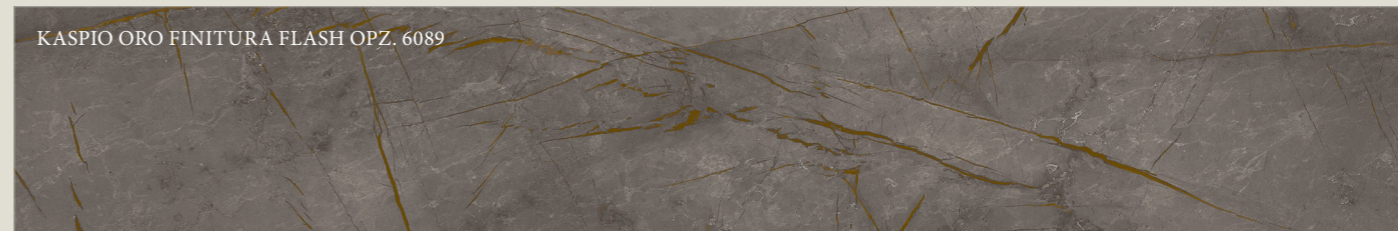

CREMA MARFIL FINITURA VELVET OPZ. 6105

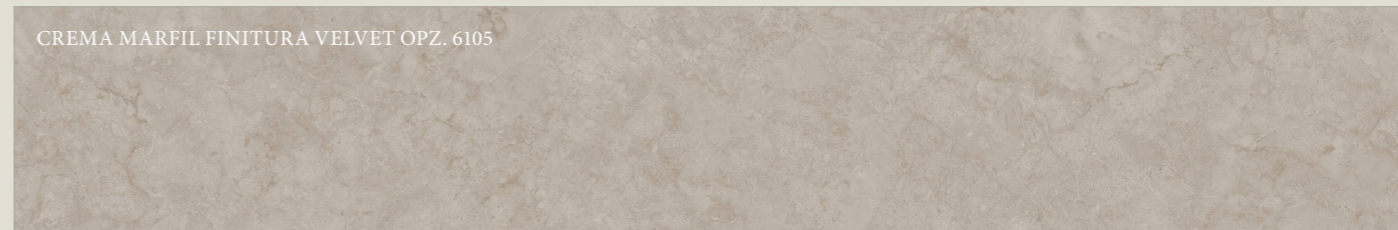

ONICE PERLA FINITURA KER OPZ. 3520

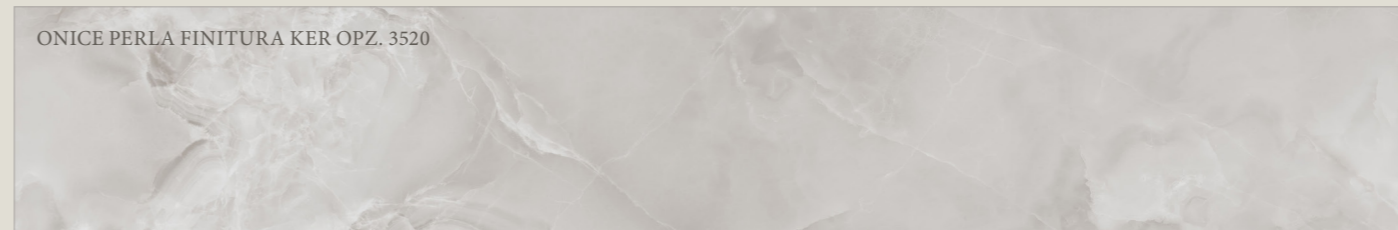

CALACATTA ORO OPZ. OL09

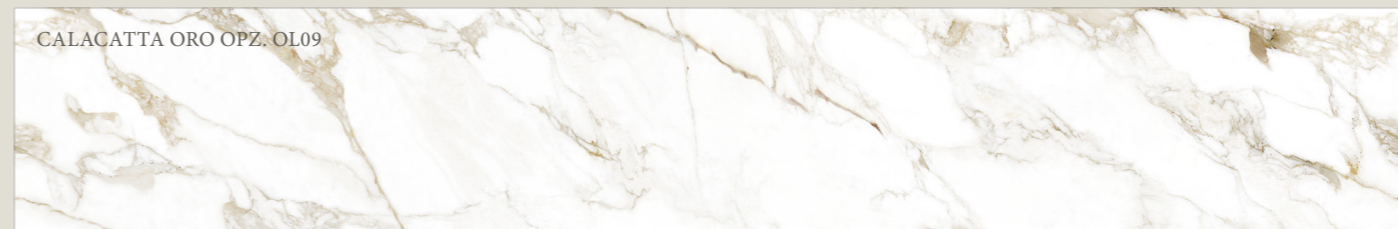

# FINITURA EFFETTO MARMO

MARBLE-EFFECT FINISH

BRECCIA IMPERIALE FINITURA VELVET OPZ. 6101



PIETRA GRIGIA FINITURA VELVET OPZ. 2669

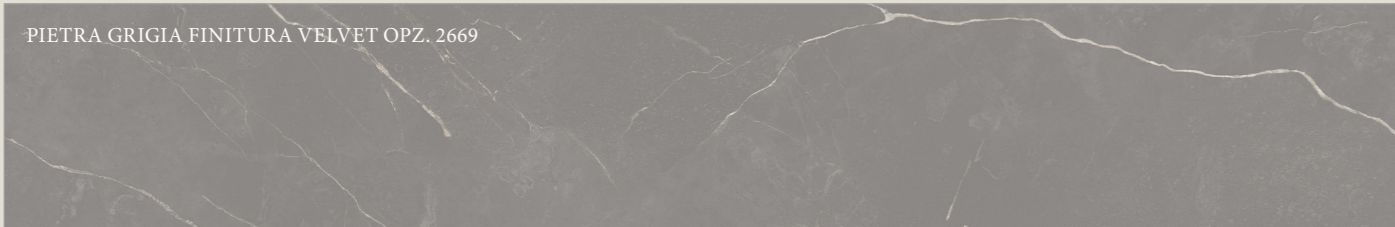

MARMO GUATEMALA FINITURA URBAN OPZ. 3522



DARK SHELL FINITURA LUNA OPZ. 3516



LIGHT SHELL FINITURA LUNA OPZ. 3515

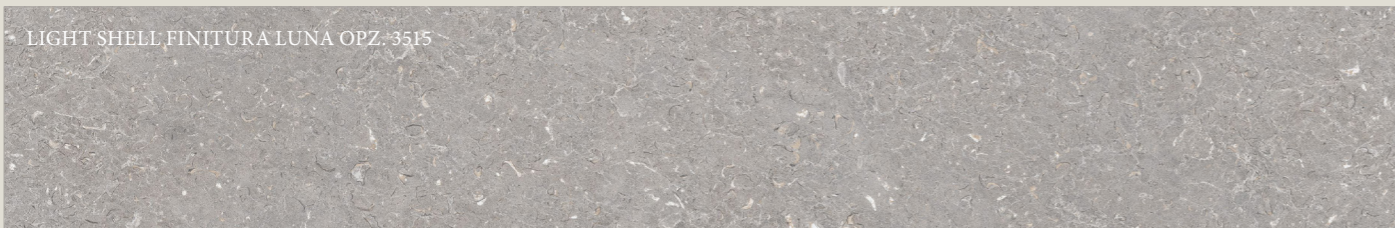

CRISTALLO BIANCO FINITURA LUNA OPZ. 3540

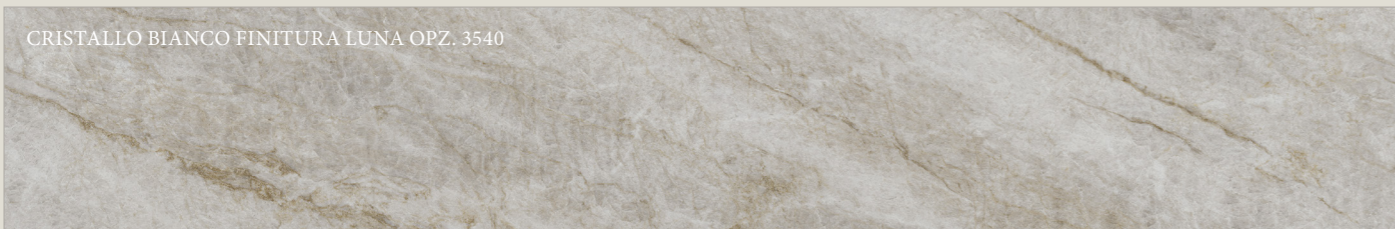

MASADA FINITURA LUNA OPZ. 3517



SAMAS FINITURA URBAN OPZ. 3482



VULCANO ORO FINITURA LUNA OPZ. 3536

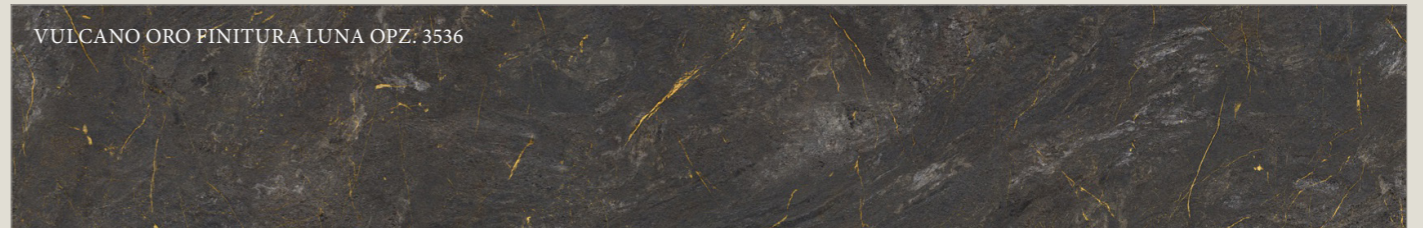

# FINITURA EFFETTO LEGNO

WOOD-EFFECT FINISH

ROVERE GRIGIO OPZ. 3264



NOCE SINFONIA OPZ. 4625



NOCE CANALETTO OPZ. 5501



ROVERE LAND OPZ. C007

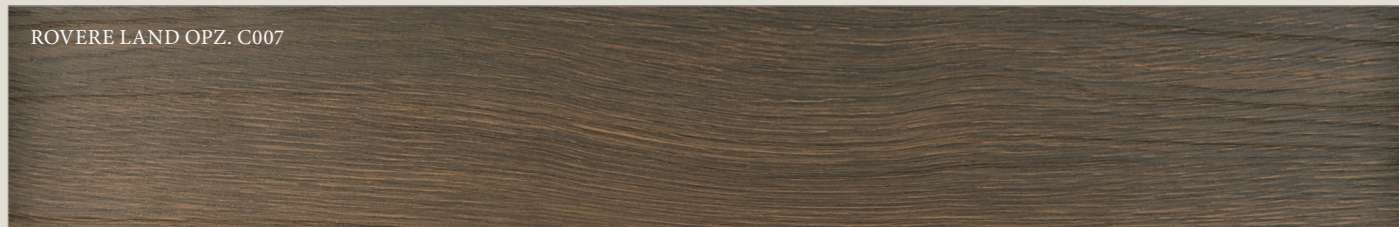

BRAMBLE FINITURA ALEVÈ OPZ. 4611



ROVERE ANTICO FINITURA WOOD OPZ. 2415

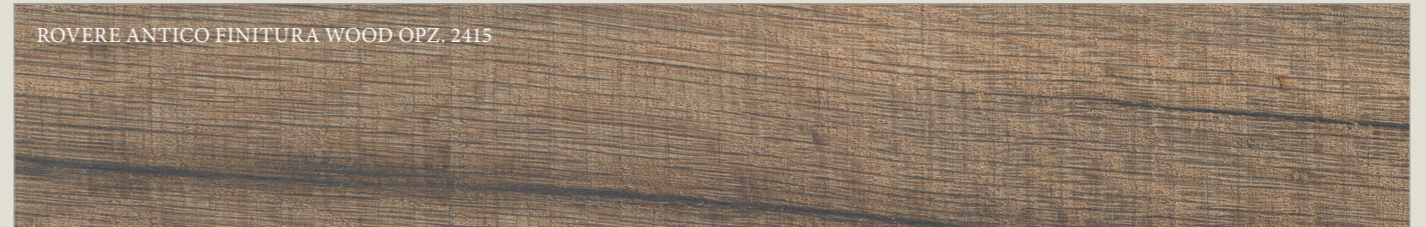

ROVERE SLAVONIA FINITURA ALEVÈ OPZ. 4587



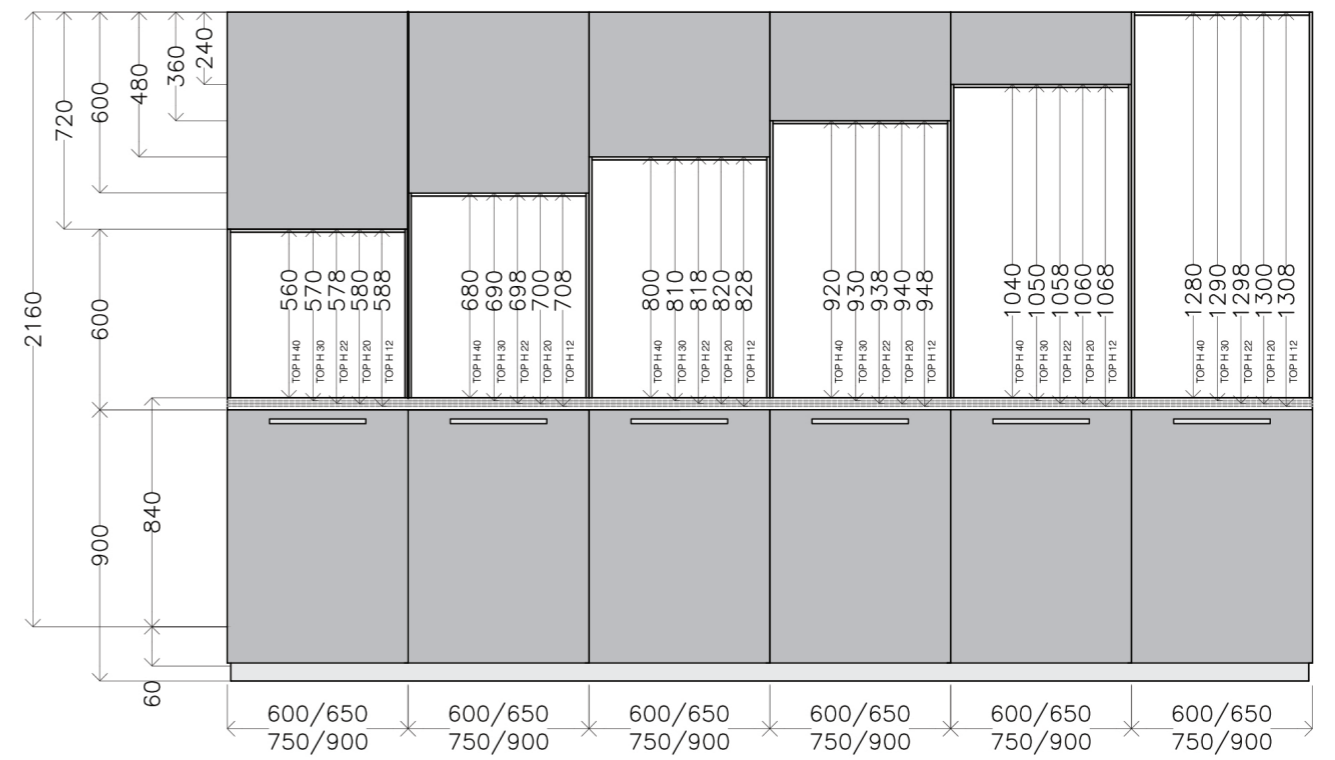
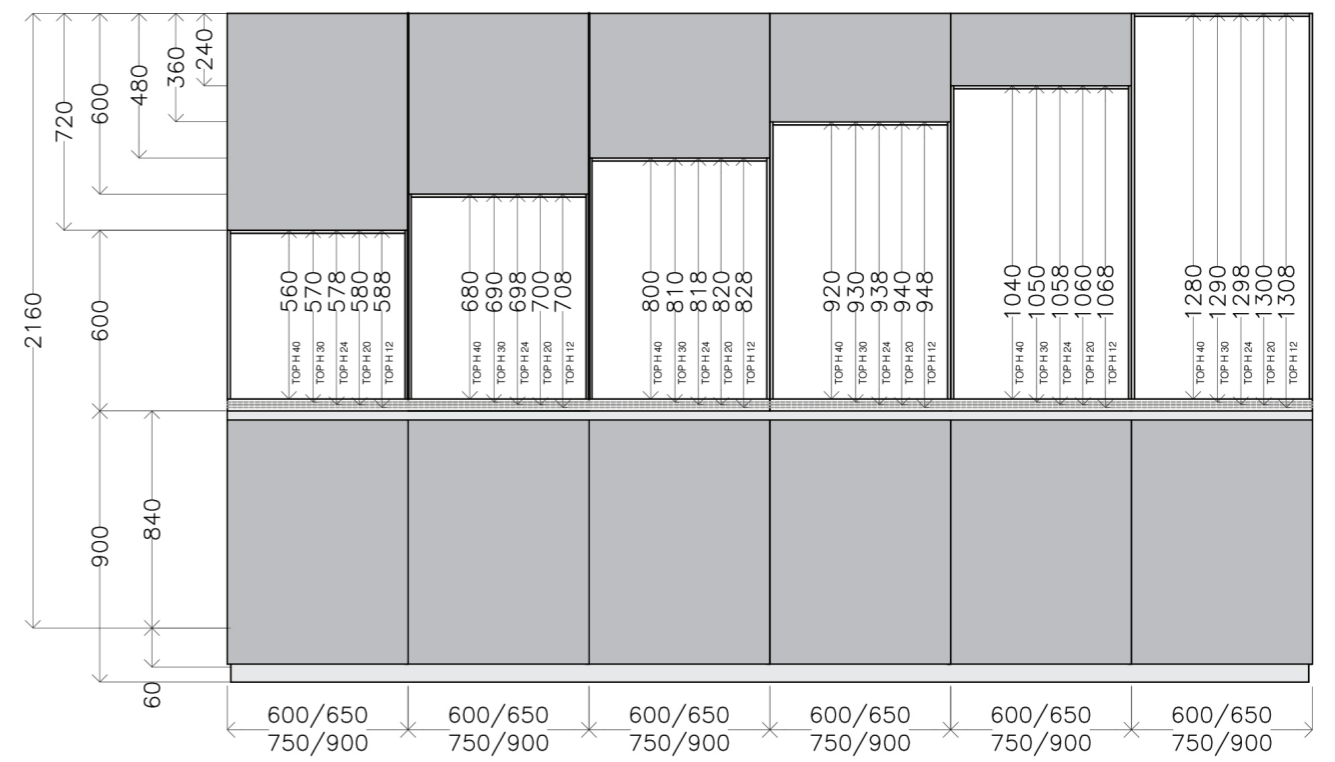
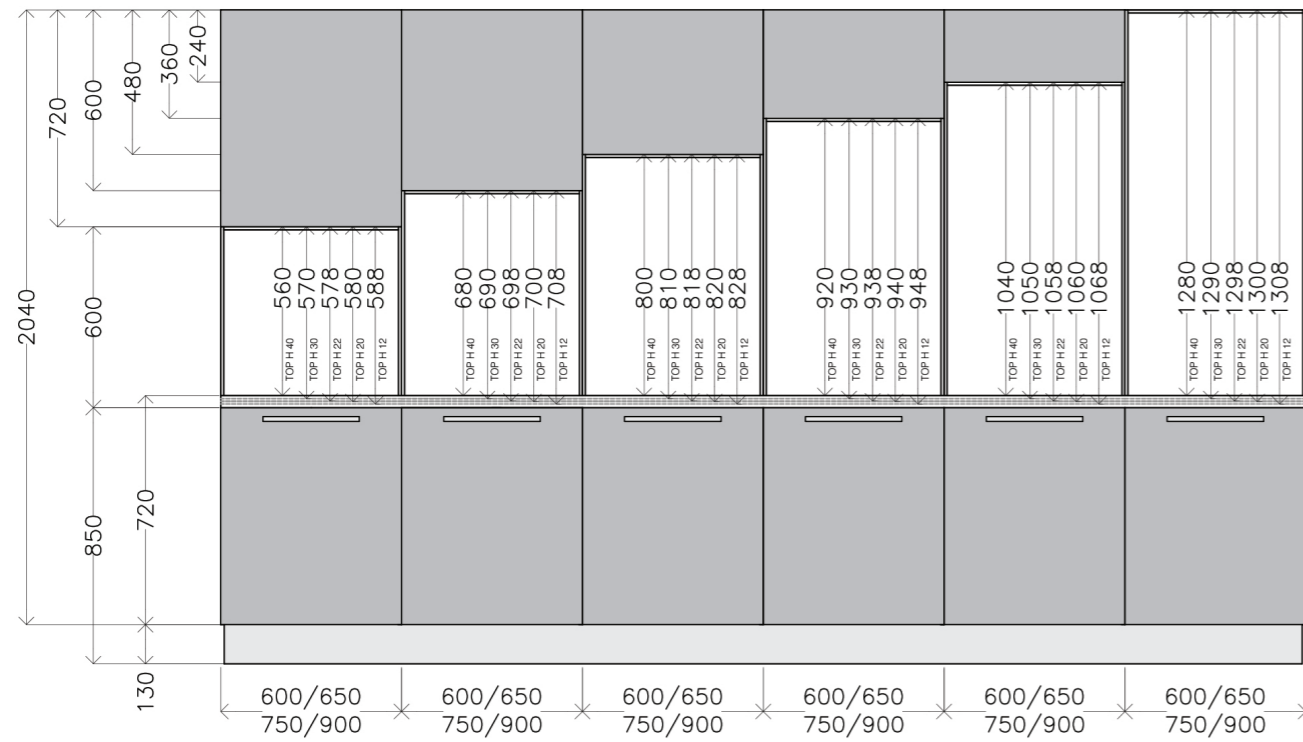
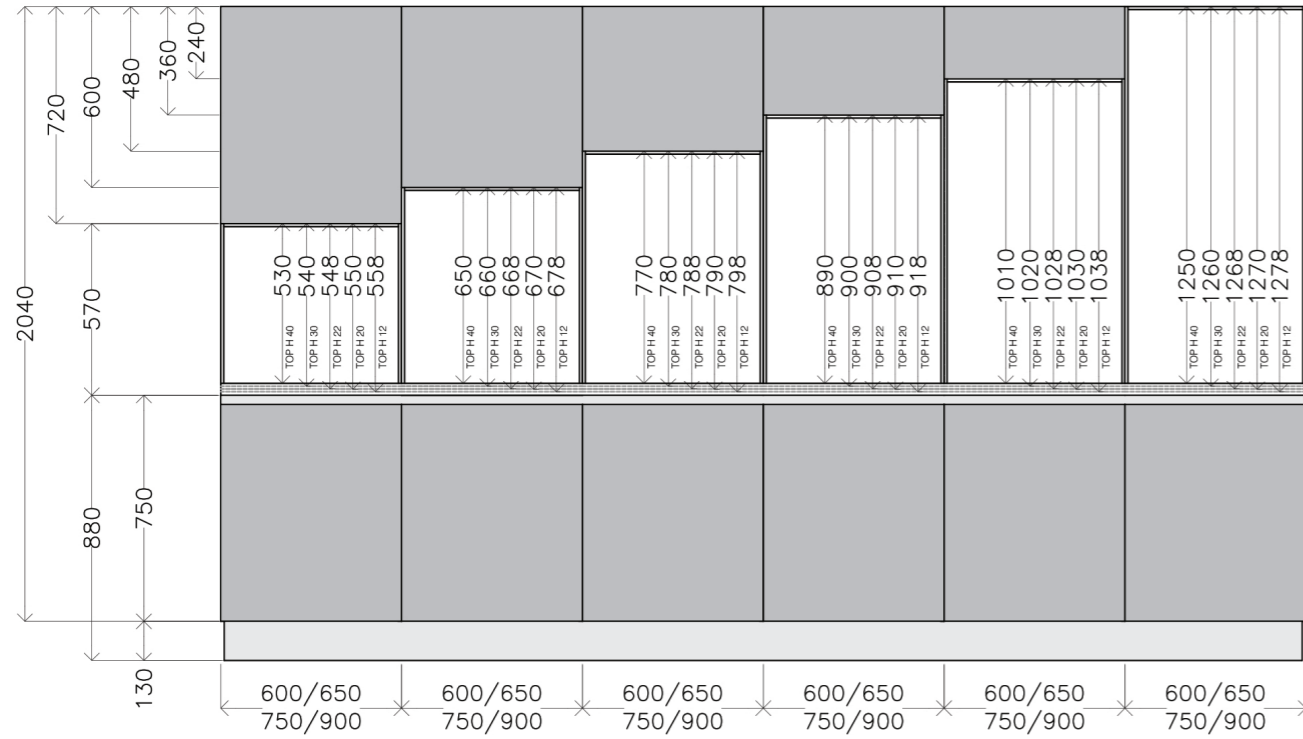

**STRUTTURA E RIPIANI ALLUMINIO SENZA SCHIENA**  
**BACK PANEL ALUMINUM FRAME AND SHELVES**



COD.

modulo P.14,2 in appoggio  
con ripiano alluminio, senza schiena

**N.B.: si effettuano fuori misura solo in larghezza  
per gli stessi considerare prezzo dell'elemento  
di misura immediatamente superiore.**

module D.14.2 in support  
with aluminum shelf, without back panel

**Note: they are made out of size only in width  
for the same consider the price of the element  
of the immediately larger size.**

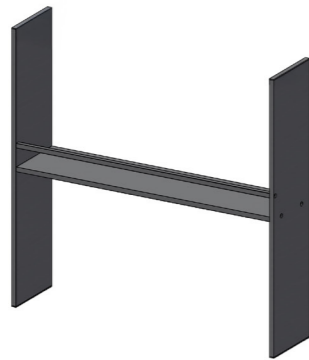

<b>L 60</b> da H 53 a H 58,8	086TK2A60
<b>L 65</b> da H 53 a H 58,8	086TK2A65
<b>L 75</b> da H 53 a H 58,8	086TK2A75
<b>L 90</b> da H 53 a H 58,8	086TK2A90

COD.

modulo P.14,2 in appoggio con 2 ripiani  
alluminio, senza schiena

**N.B.: si effettuano fuori misura solo in larghezza  
per gli stessi considerare prezzo dell'elemento  
di misura immediatamente superiore.**

module D.14.2 supported with 2 shelves  
aluminum, without back panel

**Note: they are made out of size only in width  
for the same consider the price of the element  
of the immediately larger size.**

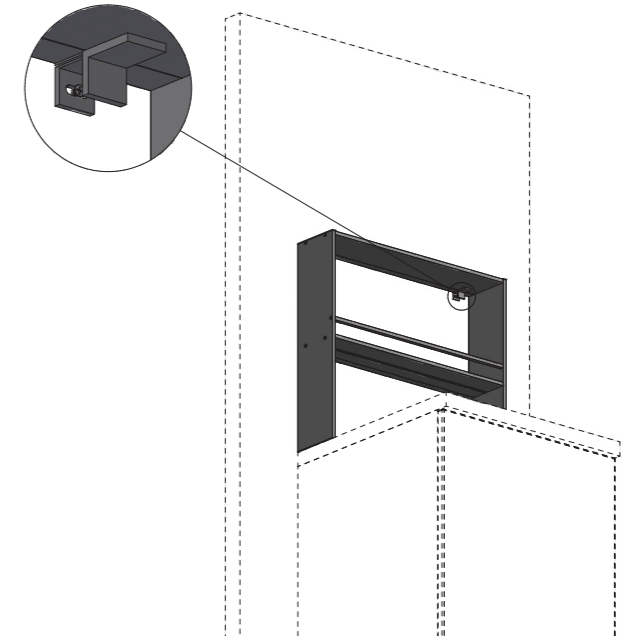

Particolare fissaggio a muro  
Wall fixing detail



<b>L 60</b> da H 65 a H 70,8	086TK2B60
<b>L 65</b> da H 65 a H 70,8	086TK2B65
<b>L 75</b> da H 65 a H 70,8	086TK2B75
<b>L 90</b> da H 65 a H 70,8	086TK2B90



COD.

modulo P.14,2 in appoggio con 2 ripiani alluminio, senza schiena

**N.B.: si effettuano fuori misura solo in larghezza per gli stessi considerare prezzo dell'elemento di misura immediatamente superiore.**

module D.14.2 supported with 2 shelves aluminum, without back panel

**Note: they are made out of size only in width for the same consider the price of the element of the immediately larger size.**

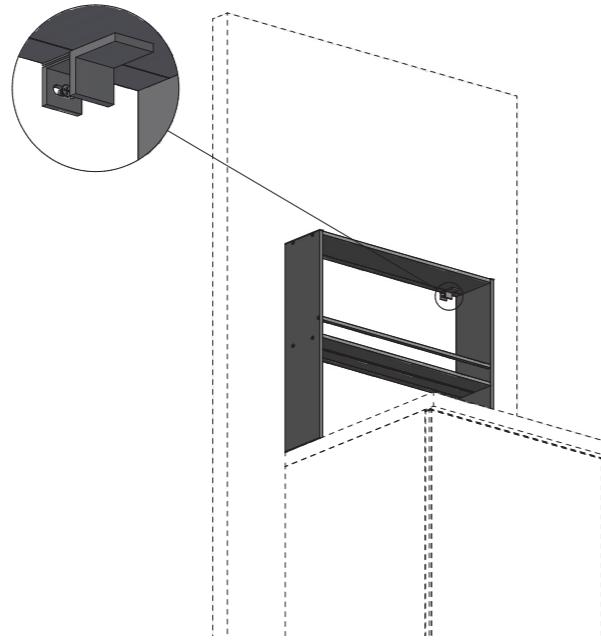

Particolare fissaggio a muro  
Wall fixing detail

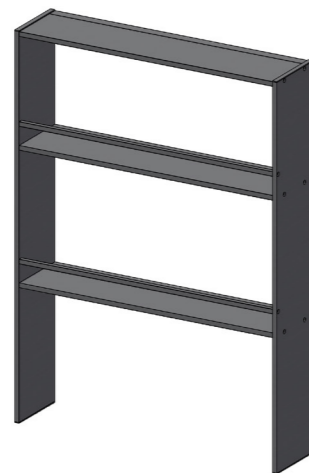

L 60	086TK2C60
da H 77 a H 82,8	
L 65	086TK2C65
da H 77 a H 82,8	
L 75	086TK2C75
da H 77 a H 82,8	
L 90	086TK2C90
da H 77 a H 82,8	

COD.

modulo P.14,2 in appoggio con 2 ripiani alluminio, senza schiena

**N.B.: si effettuano fuori misura solo in larghezza per gli stessi considerare prezzo dell'elemento di misura immediatamente superiore.**

module D.14.2 supported with 2 shelves aluminum, without back panel

**Note: they are made out of size only in width for the same consider the price of the element of the immediately larger size.**

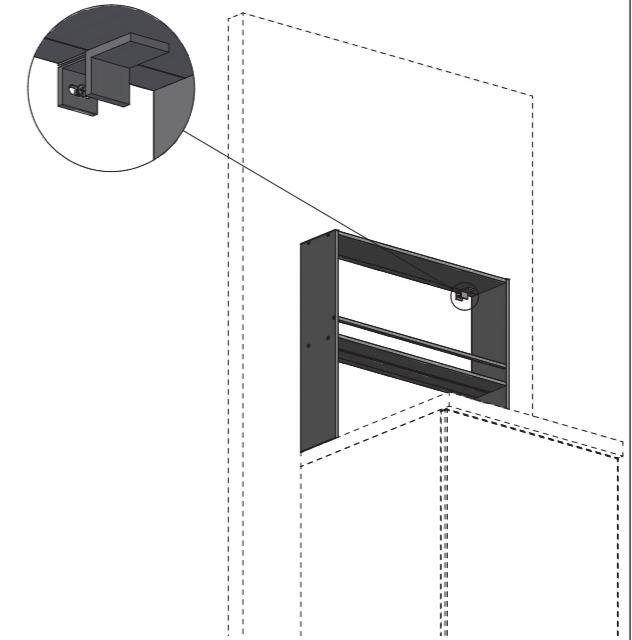

Particolare fissaggio a muro  
Wall fixing detail



L 60	086TK2D60
da H 89 a H 94,8	
L 65	086TK2D65
da H 89 a H 94,8	
L 75	086TK2D75
da H 89 a H 94,8	
L 90	086TK2D90
da H 89 a H 94,8	

COD.

modulo P.14,2 in appoggio con 3 ripiani alluminio, senza schiena

**N.B.: si effettuano fuori misura solo in larghezza per gli stessi considerare prezzo dell'elemento di misura immediatamente superiore.**

module D.14.2 supported with 3 shelves aluminum, without back panel

**Note: they are made out of size only in width for the same consider the price of the element of the immediately larger size.**

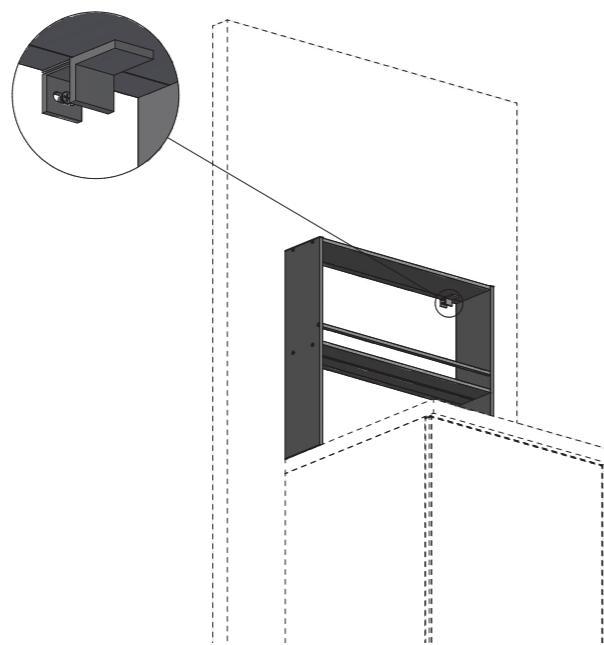

Particolare fissaggio a muro  
Wall fixing detail

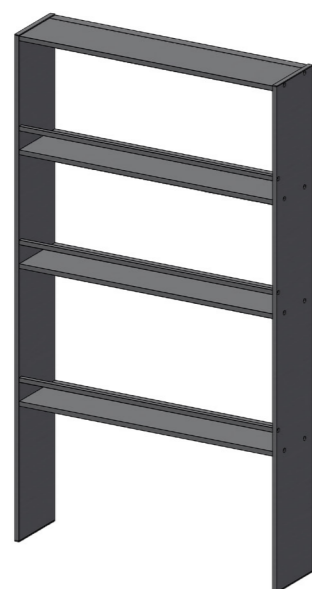

L 60	086TK2E60
da H 101 a H 106,8	
L 65	086TK2E65
da H 101 a H 106,8	
L 75	086TK2E75
da H 101 a H 106,8	
L 90	086TK2E90
da H 101 a H 106,8	

COD.

modulo P.14,2 in appoggio con 4 ripiani alluminio, senza schiena

**N.B.: si effettuano fuori misura solo in larghezza per gli stessi considerare prezzo dell'elemento di misura immediatamente superiore.**

module D.14.2 supported with 4 shelves aluminum, without back panel

**Note: they are made out of size only in width for the same consider the price of the element of the immediately larger size.**

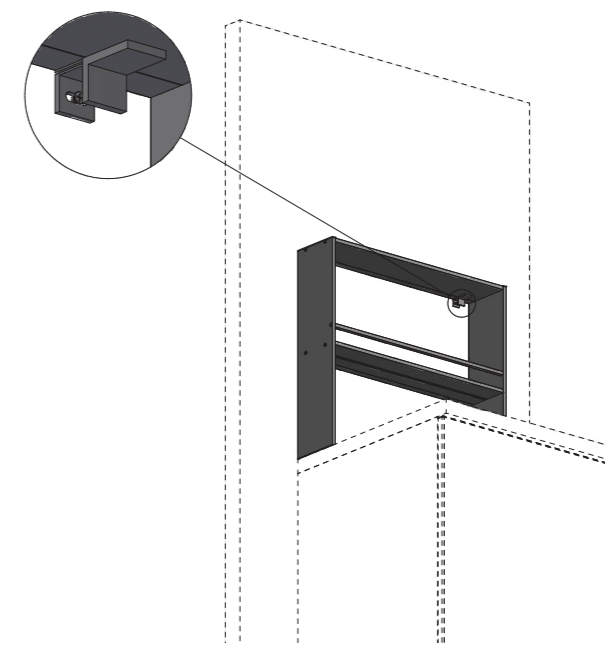

Particolare fissaggio a muro  
Wall fixing detail



L 60	086TK2F60
da H 125 a H 130,8	
L 60	086TK2F65
da H 125 a H 130,8	
L 60	086TK2F75
da H 125 a H 130,8	
L 60	086TK2F90
da H 125 a H 130,8	

COD.

modulo sospeso P.14,2 in appoggio con 4 ripiani alluminio, senza schiena

**N.B.:** si effettuano fuori misura solo in larghezza per gli stessi considerare prezzo dell'elemento di misura immediatamente superiore.

suspended module D.14.2 supported with 4 shelves aluminum, without back panel

Note: they are made out of size only in width for the same consider the price of the element of the immediately larger size.

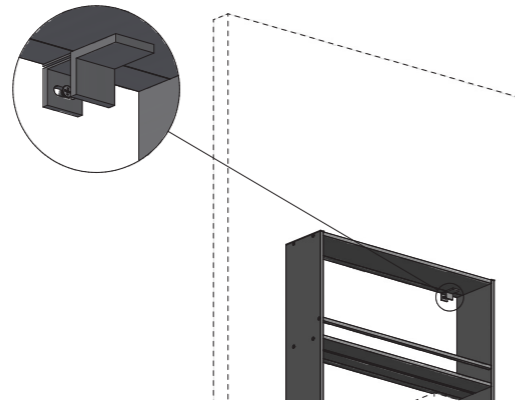

Particolare fissaggio a muro  
Wall fixing detail



H 132 L 60	086TK3Q60
H 132 L 75	086TK3Q75
H 132 L 90	086TK3Q90

COD.

modulo sospeso P.14,2 in appoggio con 3 ripiani alluminio, senza schiena

**N.B.:** si effettuano fuori misura solo in larghezza per gli stessi considerare prezzo dell'elemento di misura immediatamente superiore.

suspended module D.14.2 supported with 3 shelves aluminum, without back panel

Note: they are made out of size only in width for the same consider the price of the element of the immediately larger size.

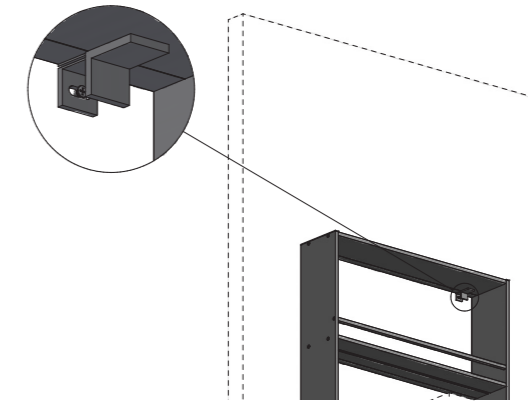

Particolare fissaggio a muro  
Wall fixing detail



H 132 L 60	086TK3P60
H 132 L 75	086TK3P75
H 132 L 90	086TK3P90
H 144 L 60	086TK3R60
H 144 L 75	086TK3R75
H 144 L 90	086TK3R90

**RETROTOP "TIEKO" PER BASI H 75 ZOCCOLO H 13 CON GOLA**  
"TIEKO" RETROTOP FOR BASE UNITS H 75 PLINTH H 13 WITH GROOVE

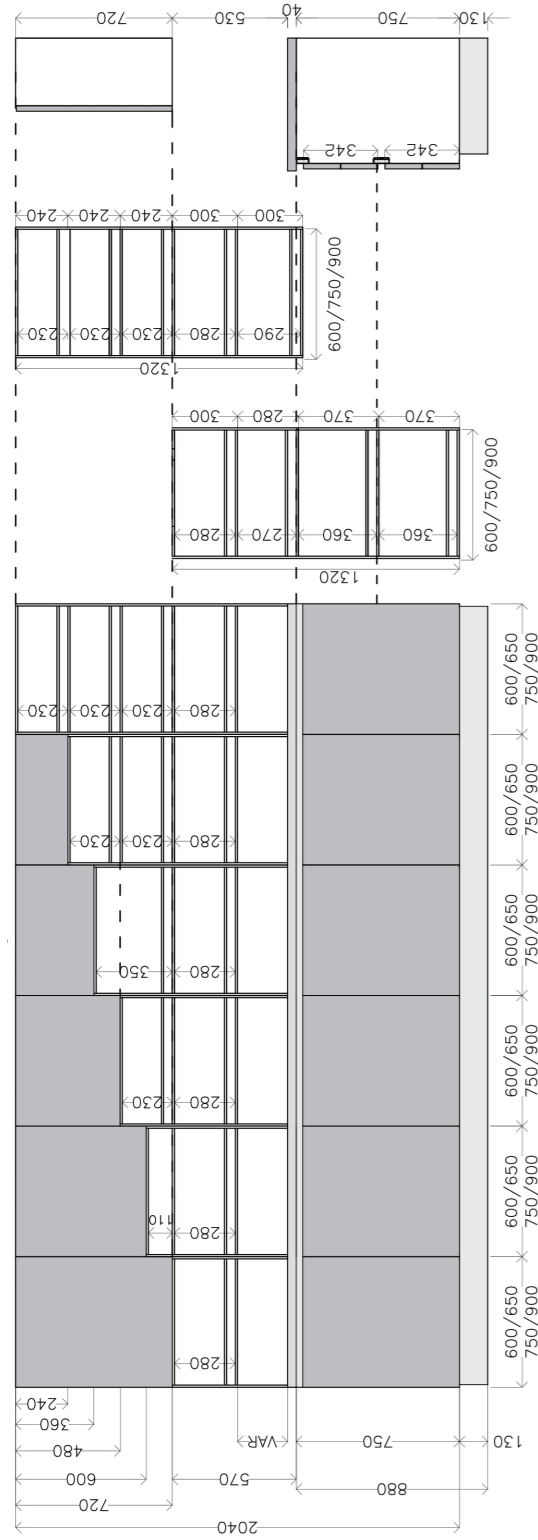

**RETROTOP "TIEKO" PER BASI H 72 ZOCCOLO H 13 SENZA GOLA**  
"TIEKO" RETROTOP FOR BASES H 72 PLINTHS H 13 WITHOUT GROOVE

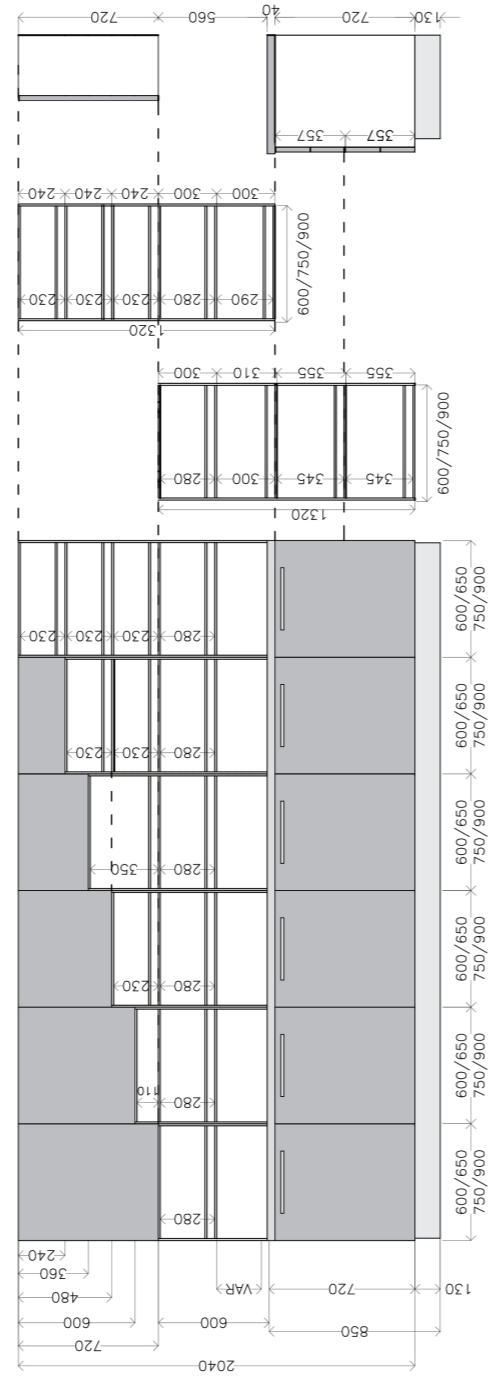

**RETROTOP "TIEKO" PER BASI H 84 ZOCCOLO H 6 CON GOLA**  
"TIEKO" RETROTOP FOR BASE UNITS H84 PLINTH H 6 WITH GROOVE

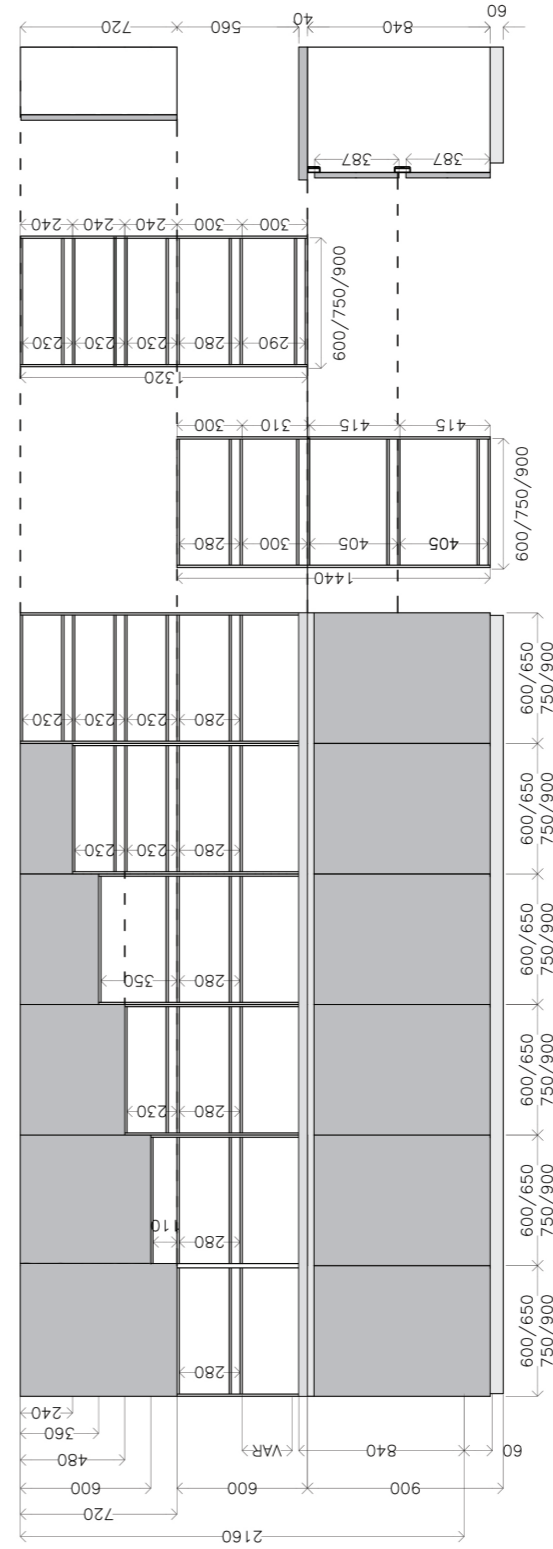

**RETROTOP "TIEKO" PER BASI H 84 ZOCCOLO H 6 SENZA GOLA**  
"TIEKO" RETROTOP FOR BASES H 84 PLINTHS H 6 WITHOUT GROOVE

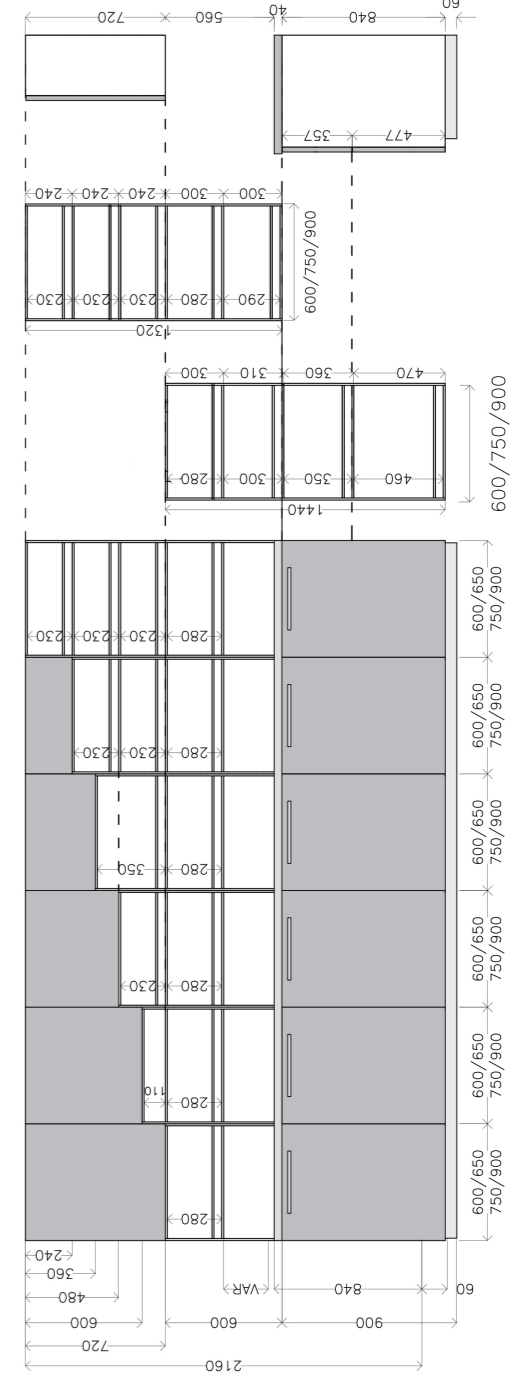

STRUTTURA E RIPIANI ALLUMINIO, SCHIENA NELLE FINITURE  
INSERITE A LISTINO CON E SENZA LUCI

ALUMINIUM FRAME AND SHELVES, BACK PANEL IN THE FINISHES INCLUDED  
IN THE PRICE LIST WITH AND WITHOUT LIGHTS



# SISTEMA D'ARREDO "TIEKO"

"TIEKO" FURNISHING SYSTEM

GRUPPO LUBE

P 14,2

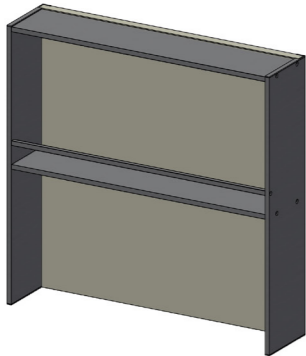
		MELAMINICI	MATHERA PET IMMAGINA	WOOD	FENIX	LACCATO UV	LACCATO OPACO	LACCATO SUPER OPACO	LACCATO COME TOP	LAMINATO COME TOP	IMPIALLACCATO	IMPIALLACCATO
	COD.										FASCIA A	FASCIA B
<p><b>modulo P.14,2 in appoggio con ripiano alluminio</b>  <b>N.B.: si effettuano fuori misura solo in larghezza per gli stessi considerare prezzo dell'elemento di misura immediatamente superiore.</b>                      P.14.2 module supported with aluminium shelf                      Note: they are made out of size only in width for the same consider the price of the element of the immediately larger size.</p> 												
<p><b>L 60</b>                      da H 53 a H 58,8  <b>maggiorazione luce</b>                      surcharge light</p>	086TK2AA60											
<p><b>L 65</b>                      da H 53 a H 58,8  <b>maggiorazione luce</b>                      surcharge light</p>	086TK2AA65											
<p><b>L 75</b>                      da H 53 a H 58,8  <b>maggiorazione luce</b>                      surcharge light</p>	086TK2AA75											
<p><b>L 90</b>                      da H 53 a H 58,8  <b>maggiorazione luce</b>                      surcharge light</p>	086TK2AA90											

# SISTEMA D'ARREDO "TIEKO"

"TIEKO" FURNISHING SYSTEM

GRUPPO LUBE

P 14,2

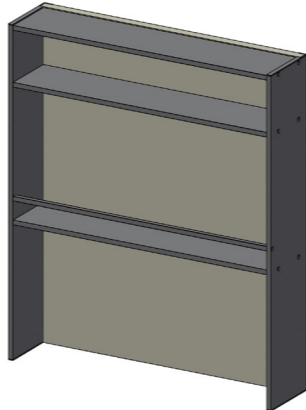
		MELAMINICI	MATHERA PET IMMAGINA	WOOD	FENIX	LACCATO UV	LACCATO OPACO	LACCATO SUPER OPACO	LACCATO COME TOP	LAMINATO COME TOP	IMPIALLACCATO	IMPIALLACCATO
	COD.										FASCIA A	FASCIA B
<p><b>modulo P.14,2 in appoggio con 2 ripiani alluminio</b>  <b>N.B.: si effettuano fuori misura solo in larghezza per gli stessi considerare prezzo dell'elemento di misura immediatamente superiore.</b>                      module D.14.2 supported with 2 shelves aluminum                      Note: they are made out of size only in width for the same consider the price of the element of the immediately larger size.</p> 												
<p><b>L 60</b>                      da H 65 a H 70,8  <b>maggiorazione luce</b>                      surcharge light</p>	086TK2AB60											
<p><b>L 65</b>                      da H 65 a H 70,8  <b>maggiorazione luce</b>                      surcharge light</p>	086TK2AB65											
<p><b>L 75</b>                      da H 65 a H 70,8  <b>maggiorazione luce</b>                      surcharge light</p>	086TK2AB75											
<p><b>L 90</b>                      da H 65 a H 70,8  <b>maggiorazione luce</b>                      surcharge light</p>	086TK2AB90											







# SISTEMA D'ARREDO "TIEKO"

"TIEKO" FURNISHING SYSTEM

GRUPPO LUBE

P 14,2

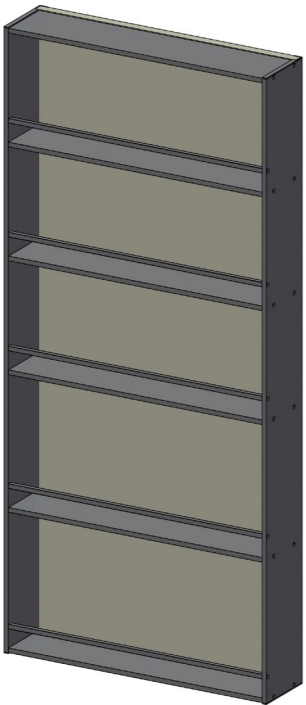
	COD.	MELAMINICI	MATHERA PET IMMAGINA	WOOD	FENIX	LACCATO UV	LACCATO OPACO	LACCATO SUPER OPACO	LACCATO COME TOP	LAMINATO COME TOP	IMPIALLACCATO	IMPIALLACCATO
											FASCIA A	FASCIA B
<p>modulo P.14,2 in appoggio con 4 ripiani alluminio</p> <p><b>N.B.: si effettuano fuori misura solo in larghezza per gli stessi considerare prezzo dell'elemento di misura immediatamente superiore.</b></p> <p>module D.14.2 supported with 4 shelves aluminum</p> <p><b>Note: they are made out of size only in width for the same consider the price of the element of the immediately larger size.</b></p> 												
H 132 L 60	086TK3AQ60											
maggiorazione luce surcharge light												
H 132 L 75	086TK3AQ75											
maggiorazione luce surcharge light												
H 132 L 90	086TK3AQ90											
maggiorazione luce surcharge light												

# SISTEMA D'ARREDO "TIEKO"

"TIEKO" FURNISHING SYSTEM

GRUPPO LUBE

P 14,2

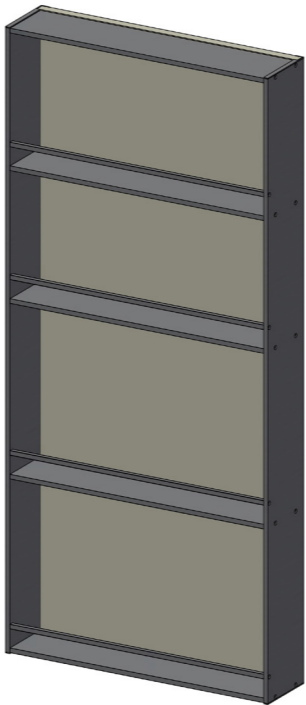
	COD.	MELAMINICI	MATHERA PET IMMAGINA	WOOD	FENIX	LACCATO UV	LACCATO OPACO	LACCATO SUPER OPACO	LACCATO COME TOP	LAMINATO COME TOP	IMPIALLACCATO	IMPIALLACCATO
											FASCIA A	FASCIA B
<p>colonna H 132/144 P.14,2 sospeso con 3 ripiani alluminio</p> <p><b>N.B.: si effettuano fuori misura solo in larghezza per gli stessi considerare prezzo dell'elemento di misura immediatamente superiore.</b></p> <p>H 132/144 D.14.2 suspended column with 3 aluminium shelves</p> <p><b>Note: they are made out of size only in width for the same consider the price of the element of the immediately larger size.</b></p> 												
H 132 L 60	086TK3AP60											
maggiorazione luce surcharge light												
H 132 L 75	086TK3AP75											
maggiorazione luce surcharge light												
H 132 L 90	086TK3AP90											
maggiorazione luce surcharge light												
H 144 L 60	086TK3AR60											
maggiorazione luce surcharge light												
H 144 L 75	086TK3AR75											
maggiorazione luce surcharge light												
H 144 L 90	086TK3AR90											
maggiorazione luce surcharge light												

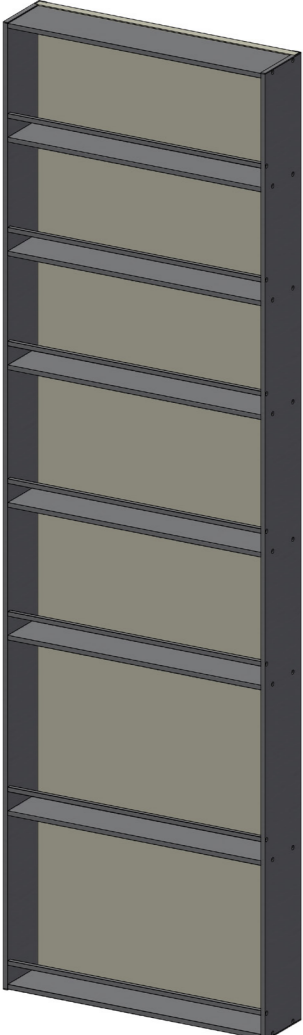
	COD.	MELAMINICI	MATHERA PET IMMAGINA	WOOD	FENIX	LACCATO UV	LACCATO OPACO	LACCATO SUPER OPACO	LACCATO COME TOP	LAMINATO COME TOP	IMPIALLACCATO	IMPIALLACCATO
											FASCIA A	FASCIA B
<p>colonna H 204/216 P.14,2 sospeso con 3 ripiani alluminio</p> <p><b>N.B.: si effettuano fuori misura solo in larghezza per gli stessi considerare prezzo dell'elemento di misura immediatamente superiore.</b></p> <p>H 204/216 D.14.2 suspended column with 3 aluminium shelves</p> <p>Note: they are made out of size only in width for the same consider the price of the element of the immediately larger size.</p> 												
H 204 L 60	086TK3AS60											
maggiorazione luce surcharge light												
H 204 L 75	086TK3AS75											
maggiorazione luce surcharge light												
H 204 L 90	086TK3AS90											
maggiorazione luce surcharge light												
H 216 L 60	086TK3AU60											
maggiorazione luce surcharge light												
H 216 L 75	086TK3AU75											
maggiorazione luce surcharge light												
H 216 L 90	086TK3AU90											
maggiorazione luce surcharge light												

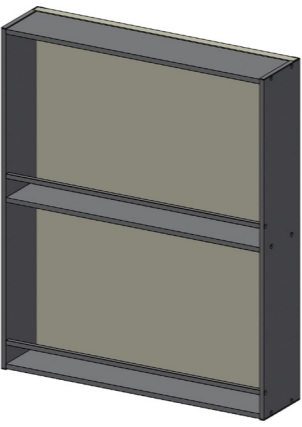
	COD.	MELAMINICI	MATHERA PET IMMAGINA	WOOD	FENIX	LACCATO UV	LACCATO OPACO	LACCATO SUPER OPACO	LACCATO COME TOP	LAMINATO COME TOP	IMPIALLACCATO	IMPIALLACCATO
											FASCIA A	FASCIA B
<p>modulo retro isola/ penisola sospeso P.14,2 con ripiano alluminio</p> <p><b>N.B.: si effettuano fuori misura solo in larghezza per gli stessi considerare prezzo dell'elemento di misura immediatamente superiore.</b></p> <p>suspended island/peninsula back module D.14.2 with aluminum shelf</p> <p>Note: they are made out of size only in width for the same consider the price of the element of the immediately larger size.</p> 												
<p><b>N.B.: per il fissaggio degli elementi retro isola/penisola, predisporre sempre le basi alle quali vanno contrapposti, con pannello di finitura posteriore colore cassa o come anta.</b></p> <p>Note: to fix the elements back of the island/peninsula, always prepare the bases to which they will be placed, with a rear finishing panel in the same color as the door.</p>												
H 72 L 60	086TK3AK60											
H 75 L 60	086TK3AL60											
H 84 L 60	086TK3AM60											
maggiorazione luce surcharge light												
H 72 L 65	086TK3AK65											
H 75 L 65	086TK3AL65											
H 84 L 65	086TK3AM65											
maggiorazione luce surcharge light												
H 72 L 75	086TK3AK75											
H 75 L 75	086TK3AL75											
H 84 L 75	086TK3AM75											
maggiorazione luce surcharge light												
H 72 L 90	086TK3AK90											
H 75 L 90	086TK3AL90											
H 84 L 90	086TK3AM90											
maggiorazione luce surcharge light												
H 72 L 110	086TK3AK93											
H 75 L 110	086TK3AL93											
H 84 L 110	086TK3AM93											
maggiorazione luce surcharge light												

# SISTEMA D'ARREDO "TIEKO"

"TIEKO" FURNISHING SYSTEM

GRUPPO LUBE

P 14,2

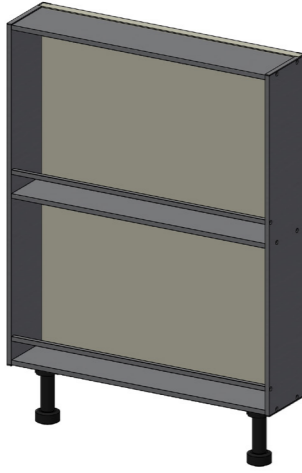
		MELAMINICI	MATHERA PET IMMAGINA	WOOD	FENIX	LACCATO UV	LACCATO OPACO	LACCATO SUPER OPACO	LACCATO COME TOP	LAMINATO COME TOP	IMPALLACCATO	IMPALLACCATO
	COD.										FASCIA A	FASCIA B
<p><b>modulo retro isola/ penisola sospeso P.14,2 con ripiano alluminio</b></p> <p><b>N.B.: si effettuano fuori misura solo in larghezza per gli stessi considerare prezzo dell'elemento di misura immediatamente superiore.</b></p> <p>suspended island/peninsula back module D.14.2 with aluminum shelf</p> <p><b>Note: they are made out of size only in width for the same consider the price of the element of the immediately larger size.</b></p> 												
<b>N.B.: per il fissaggio degli elementi retro isola/penisola, predisporre sempre le basi alle quali vanno contrapposti, con pannello di finitura posteriore colore cassa o come anta.</b>												
Note: to fix the elements back of the island/peninsula, always prepare the bases to which they will be placed, with a rear finishing panel in the same color as the door.												
<b>H 72 L 60</b>	086TK1AK60											
<b>H 75 L 60</b>	086TK1AL60											
<b>H 84 L 60</b>	086TK1AM60											
<b>maggiorazione luce</b> surcharge light												
<b>H 72 L 65</b>	086TK1AK65											
<b>H 75 L 65</b>	086TK1AL65											
<b>H 84 L 65</b>	086TK1AM65											
<b>maggiorazione luce</b> surcharge light												
<b>H 72 L 75</b>	086TK1AK75											
<b>H 75 L 75</b>	086TK1AL75											
<b>H 84 L 75</b>	086TK1AM75											
<b>maggiorazione luce</b> surcharge light												
<b>H 72 L 90</b>	086TK1AK90											
<b>H 75 L 90</b>	086TK1AL90											
<b>H 84 L 90</b>	086TK1AM90											
<b>maggiorazione luce</b> surcharge light												
<b>H 72 L 110</b>	086TK1AK93											
<b>H 75 L 110</b>	086TK1AL93											
<b>H 84 L 110</b>	086TK1AM93											
<b>maggiorazione luce</b> surcharge light												



**RETROTOP "TIEKO" PER BASI H 75 ZOCCOLO H 13 CON GOLA**  
"TIEKO" RETROTOP FOR BASE UNITS H 75 PLINTH H 13 WITH GROOVE

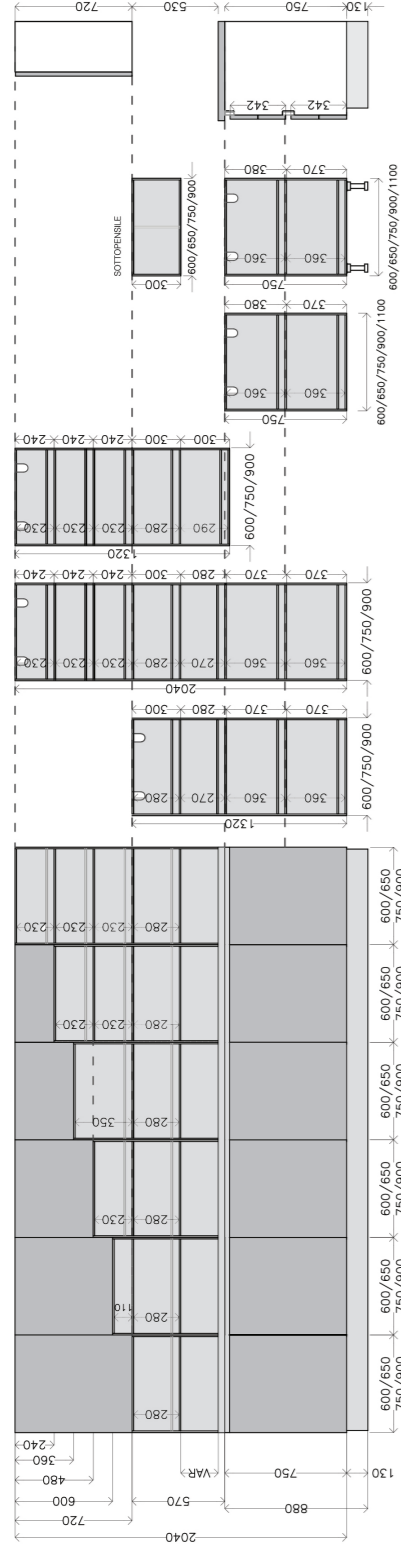

**RETROTOP "TIEKO" PER BASI H 72 ZOCCOLO H 13 SENZA GOLA**  
"TIEKO" RETROTOP FOR BASES H 72 PLINTHS H 13 WITHOUT GROOVE

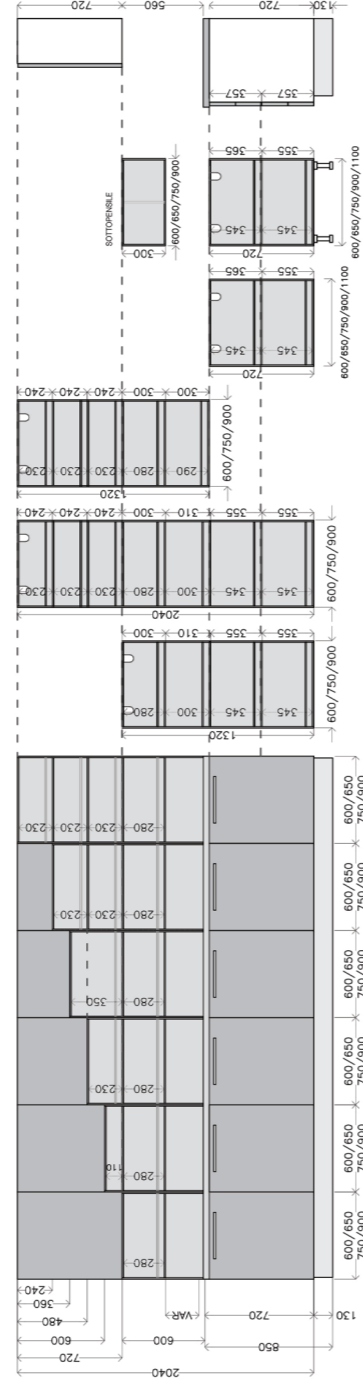

**RETROTOP "TIEKO" PER BASI H 84 ZOCCOLO H 6 CON GOLA**  
"TIEKO" RETROTOP FOR BASE UNITS H84 PLINTH H 6 WITH GROOVE

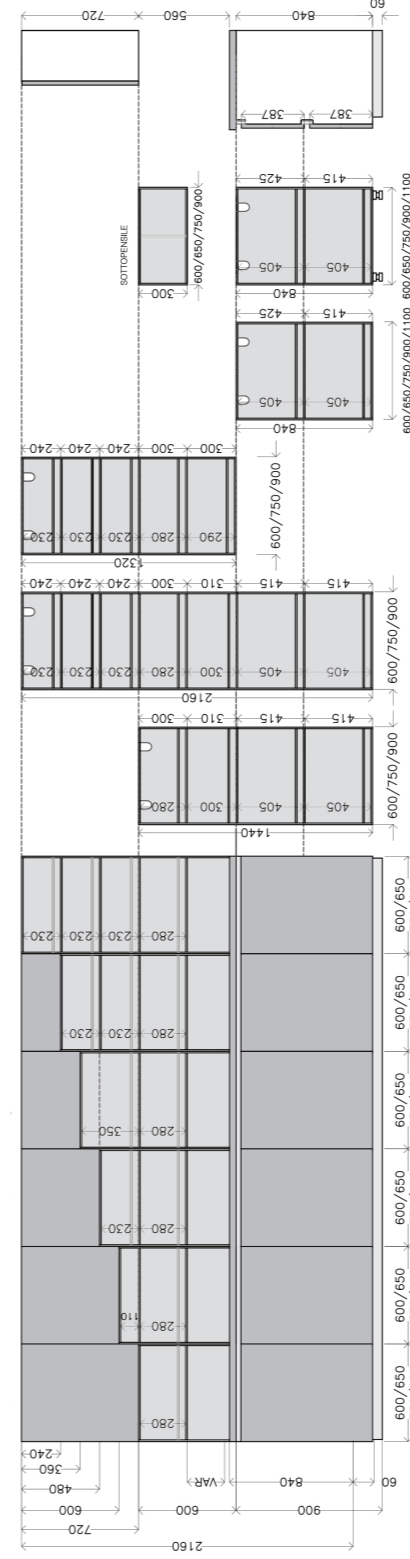

**RETROTOP "TIEKO" PER BASI H 84 ZOCCOLO H 6 SENZA GOLA**  
"TIEKO" RETROTOP FOR BASES H 84 PLINTHS H 6 WITHOUT GROOVE

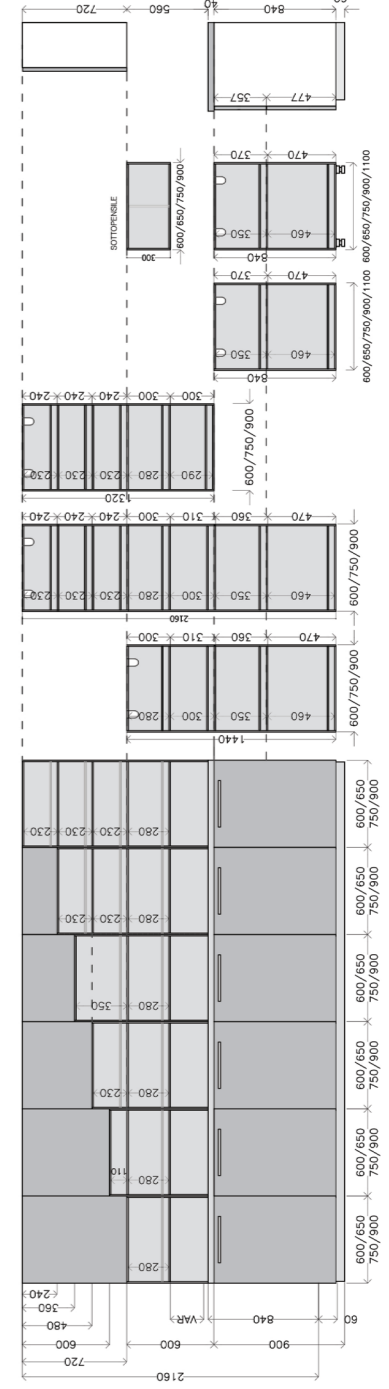

**STRUTTURA ALLUMINIO, SCHIENA E RIPIANI LEGNO NELLE  
FINITURE INSERITE A LISTINO CON E SENZA LUCI.**

**N:B.: ACCESSORI NON DISPONIBILI**

**ALUMINUM STRUCTURE, WOODEN BACK PANEL AND SHELVES IN THE  
FINISHES INCLUDED IN THE PRICE LIST WITH AND WITHOUT LIGHTS.**

**NOTE: ACCESSORIES NOT AVAILABLE**



# SISTEMA D'ARREDO "TIEKO"

"TIEKO" FURNISHING SYSTEM

GRUPPO LUBE

P 14,2

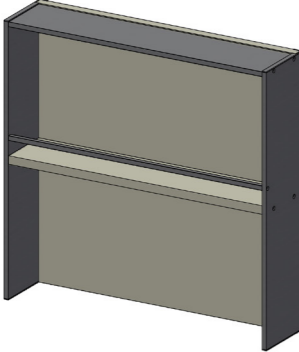
		MELAMINICI	MATHERA PET IMMAGINA	WOOD	FENIX	LACCATO UV	LACCATO OPACO	LACCATO SUPER OPACO	LACCATO COME TOP	LAMINATO COME TOP	IMPIALLACCIATO	IMPIALLACCIATO	
	COD.										FASCIA A	FASCIA B	
<p><b>modulo P.14,2 in appoggio con ripiano legno</b>  <b>N.B.: si effettuano fuori misura solo in larghezza per gli stessi considerare prezzo dell'elemento di misura immediatamente superiore.</b>                      module D.14.2 in support with wooden shelf  <b>Note: they are made out of size only in width for the same consider the price of the element of the immediately larger size.</b></p> 													
	<b>L 60</b> da H 53 a H 58,8 <b>maggiorazione luce</b> surcharge light	086TK2LA60											
	<b>L 65</b> da H 53 a H 58,8 <b>maggiorazione luce</b> surcharge light	086TK2LA65											
	<b>L 75</b> da H 53 a H 58,8 <b>maggiorazione luce</b> surcharge light	086TK2LA75											
	<b>L 90</b> da H 53 a H 58,8 <b>maggiorazione luce</b> surcharge light	086TK2LA90											

# SISTEMA D'ARREDO "TIEKO"

"TIEKO" FURNISHING SYSTEM

GRUPPO LUBE

P 14,2

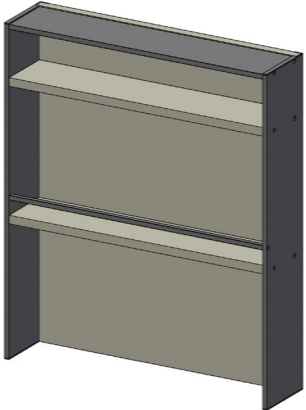
		MELAMINICI	MATHERA PET IMMAGINA	WOOD	FENIX	LACCATO UV	LACCATO OPACO	LACCATO SUPER OPACO	LACCATO COME TOP	LAMINATO COME TOP	IMPIALLACCIATO	IMPIALLACCIATO
	COD.										FASCIA A	FASCIA B
<p><b>modulo P.14,2 in appoggio con 2 ripiani legno</b>  <b>N.B.: si effettuano fuori misura solo in larghezza per gli stessi considerare prezzo dell'elemento di misura immediatamente superiore.</b>                      module D.14.2 supported with 2 shelves wood  <b>Note: they are made out of size only in width for the same consider the price of the element of the immediately larger size.</b></p> 												
	<b>L 60</b> da H 65 a H 70,8 <b>maggiorazione luce</b> surcharge light	086TK2LB60										
	<b>L 65</b> da H 65 a H 70,8 <b>maggiorazione luce</b> surcharge light	086TK2LB65										
	<b>L 75</b> da H 65 a H 70,8 <b>maggiorazione luce</b> surcharge light	086TK2LB75										
	<b>L 90</b> da H 65 a H 70,8 <b>maggiorazione luce</b> surcharge light	086TK2LB90										

# SISTEMA D'ARREDO "TIEKO"

"TIEKO" FURNISHING SYSTEM

GRUPPO LUBE

P 14,2

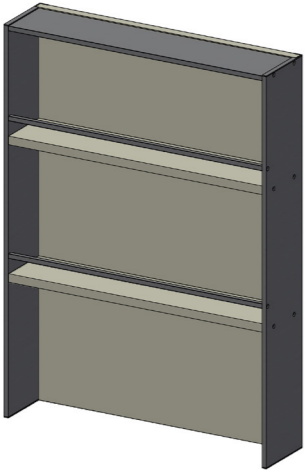
COD.	MELAMINICI	MATHERA PET IMMAGINA	WOOD	FENIX	LACCATO UV	LACCATO OPACO	LACCATO SUPER OPACO	LACCATO COME TOP	LAMINATO COME TOP	IMPALLACCATO	IMPALLACCATO
										FASCIA A	FASCIA B
<p>modulo P.14,2 in appoggio con 2 ripiani legno</p> <p><b>N.B.: si effettuano fuori misura solo in larghezza per gli stessi considerare prezzo dell'elemento di misura immediatamente superiore.</b></p> <p>module D.14.2 supported with 2 shelves wood</p> <p>Note: they are made out of size only in width for the same consider the price of the element of the immediately larger size.</p> 											
<p>L 60 da H 77 a H 82,8 maggiorazione luce surcharge light</p>	086TK2LC60										
<p>L 65 da H 77 a H 82,8 maggiorazione luce surcharge light</p>	086TK2LC65										
<p>L 75 da H 77 a H 82,8 maggiorazione luce surcharge light</p>	086TK2LC75										
<p>L 90 da H 77 a H 82,8 maggiorazione luce surcharge light</p>	086TK2LC90										

# SISTEMA D'ARREDO "TIEKO"

"TIEKO" FURNISHING SYSTEM

GRUPPO LUBE

P 14,2

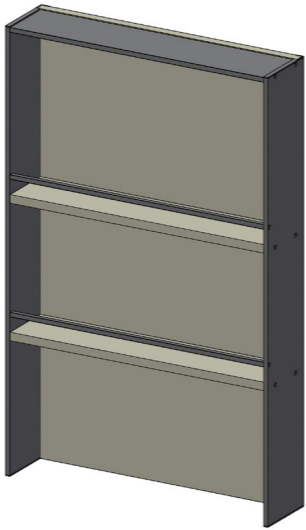
COD.	MELAMINICI	MATHERA PET IMMAGINA	WOOD	FENIX	LACCATO UV	LACCATO OPACO	LACCATO SUPER OPACO	LACCATO COME TOP	LAMINATO COME TOP	IMPALLACCATO	IMPALLACCATO
										FASCIA A	FASCIA B
<p>modulo P.14,2 in appoggio con 2 ripiani legno</p> <p><b>N.B.: si effettuano fuori misura solo in larghezza per gli stessi considerare prezzo dell'elemento di misura immediatamente superiore.</b></p> <p>module D.14.2 supported with 2 shelves wood</p> <p>Note: they are made out of size only in width for the same consider the price of the element of the immediately larger size.</p> 											
<p>L 60 da H 89 a H 94,8 maggiorazione luce surcharge light</p>	086TK2LD60										
<p>L 65 da H 89 a H 94,8 maggiorazione luce surcharge light</p>	086TK2LD65										
<p>L 75 da H 89 a H 94,8 maggiorazione luce surcharge light</p>	086TK2LD75										
<p>L 90 da H 89 a H 94,8 maggiorazione luce surcharge light</p>	086TK2LD90										

# SISTEMA D'ARREDO "TIEKO"

"TIEKO" FURNISHING SYSTEM

GRUPPO LUBE

P 14,2

	COD.	MELAMINICI	MATHERA PET IMMAGINA	WOOD	FENIX	LACCATO UV	LACCATO OPACO	LACCATO SUPER OPACO	LACCATO COME TOP	LAMINATO COME TOP	IMPIALLACCATO	IMPIALLACCATO
											FASCIA A	FASCIA B
<p>modulo P.14,2 in appoggio con 3 ripiani legno</p> <p><b>N.B.: si effettuano fuori misura solo in larghezza per gli stessi considerare prezzo dell'elemento di misura immediatamente superiore.</b></p> <p>module D.14.2 supported with 3 shelves wood</p> <p>Note: they are made out of size only in width for the same consider the price of the element of the immediately larger size.</p>												
<p>L 60 da H 101 a H 106,8 maggiorazione luce surcharge light</p>	086TK2LE60											
<p>L 65 da H 101 a H 106,8 maggiorazione luce surcharge light</p>	086TK2LE65											
<p>L 75 da H 101 a H 106,8 maggiorazione luce surcharge light</p>	086TK2LE75											
<p>L 90 da H 101 a H 106,8 maggiorazione luce surcharge light</p>	086TK2LE90											

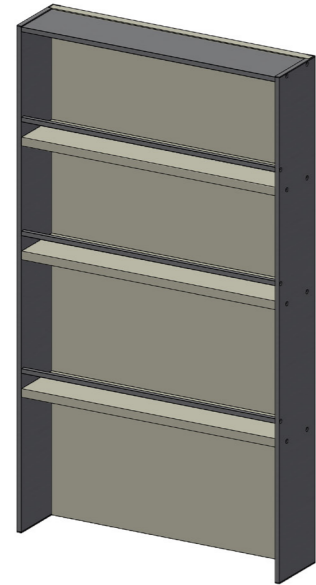

# SISTEMA D'ARREDO "TIEKO"

"TIEKO" FURNISHING SYSTEM

GRUPPO LUBE

P 14,2

	COD.	MELAMINICI	MATHERA PET IMMAGINA	WOOD	FENIX	LACCATO UV	LACCATO OPACO	LACCATO SUPER OPACO	LACCATO COME TOP	LAMINATO COME TOP	IMPIALLACCATO	IMPIALLACCATO
											FASCIA A	FASCIA B
<p>modulo P.14,2 in appoggio con 4 ripiani legno</p> <p><b>N.B.: si effettuano fuori misura solo in larghezza per gli stessi considerare prezzo dell'elemento di misura immediatamente superiore.</b></p> <p>module D.14.2 supported with 4 shelves wood</p> <p>Note: they are made out of size only in width for the same consider the price of the element of the immediately larger size.</p>												
<p>L 60 da H 125 a H 130,8 maggiorazione luce surcharge light</p>	086TK2LF60											
<p>L 65 da H 125 a H 130,8 maggiorazione luce surcharge light</p>	086TK2LF65											
<p>L 75 da H 125 a H 130,8 maggiorazione luce surcharge light</p>	086TK2LF75											
<p>L 90 da H 125 a H 130,8 maggiorazione luce surcharge light</p>	086TK2LF90											

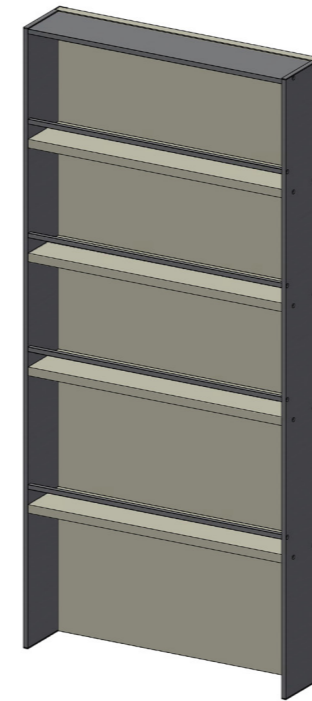



# SISTEMA D'ARREDO "TIEKO"

"TIEKO" FURNISHING SYSTEM

GRUPPO LUBE

P 14,2

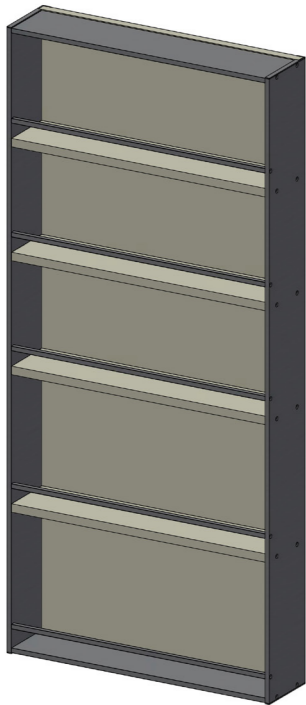
		MELAMINICI	MATHERA PET IMMAGINA	WOOD	FENIX	LACCATO UV	LACCATO OPACO	LACCATO SUPER OPACO	LACCATO COME TOP	LAMINATO COME TOP	IMPIALLACCATO	IMPIALLACCATO
	COD.										FASCIA A	FASCIA B
<p>modulo H 132 P.14,2 sospeso con 4 ripiani legno</p> <p><b>N.B.: si effettuano fuori misura solo in larghezza per gli stessi considerare prezzo dell'elemento di misura immediatamente superiore.</b></p> <p>module H 132 D.14.2 suspended with 4 shelves wood</p> <p>Note: they are made out of size only in width for the same consider the price of the element of the immediately larger size.</p> 												
H 132 L 60	086TK3LQ60											
<b>maggiorazione luce</b> surcharge light												
H 132 L 75	086TK3LQ75											
<b>maggiorazione luce</b> surcharge light												
H 132 L 90	086TK3LQ90											
<b>maggiorazione luce</b> surcharge light												

# SISTEMA D'ARREDO "TIEKO"

"TIEKO" FURNISHING SYSTEM

GRUPPO LUBE

P 14,2

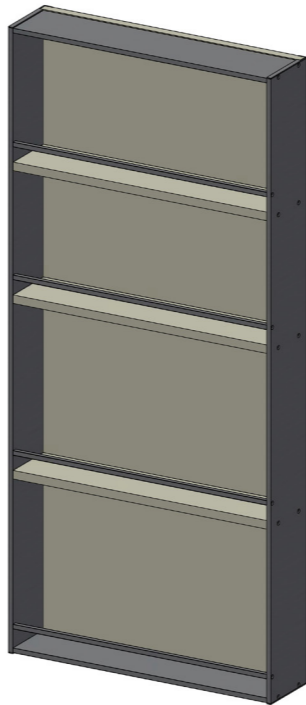
		MELAMINICI	MATHERA PET IMMAGINA	WOOD	FENIX	LACCATO UV	LACCATO OPACO	LACCATO SUPER OPACO	LACCATO COME TOP	LAMINATO COME TOP	IMPIALLACCATO	IMPIALLACCATO
	COD.										FASCIA A	FASCIA B
<p>colonna H 132/144 P.14,2 sospeso con 3 ripiani legno</p> <p><b>N.B.: si effettuano fuori misura solo in larghezza per gli stessi considerare prezzo dell'elemento di misura immediatamente superiore.</b></p> <p>column H 132/144 D.14.2 suspended with 3 wooden shelves</p> <p>Note: they are made out of size only in width for the same consider the price of the element of the immediately larger size.</p> 												
H 132 L 60	086TK3LP60											
<b>maggiorazione luce</b> surcharge light												
H 132 L 75	086TK3LP75											
<b>maggiorazione luce</b> surcharge light												
H 132 L 90	086TK3LP90											
<b>maggiorazione luce</b> surcharge light												
H 144 L 60	086TK3LR60											
<b>maggiorazione luce</b> surcharge light												
H 144 L 75	086TK3LR75											
<b>maggiorazione luce</b> surcharge light												
H 144 L 90	086TK3LR90											
<b>maggiorazione luce</b> surcharge light												

# SISTEMA D'ARREDO "TIEKO"

"TIEKO" FURNISHING SYSTEM

GRUPPO LUBE

P 14,2

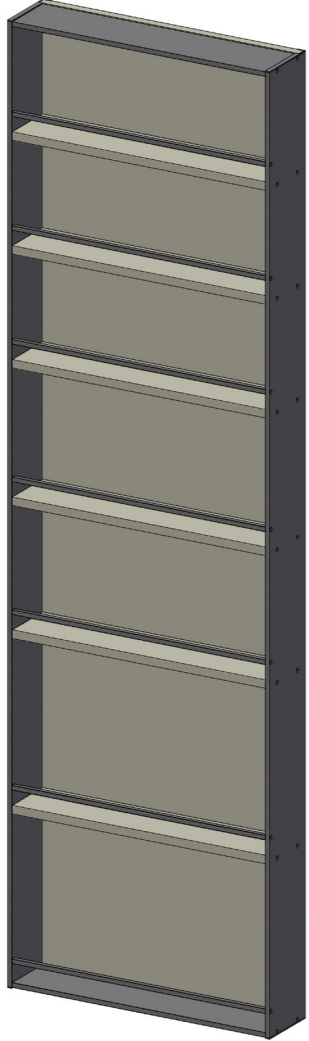
	COD.	MELAMINICI	MATHERA PET IMMAGINA	WOOD	FENIX	LACCATO UV	LACCATO OPACO	LACCATO SUPER OPACO	LACCATO COME TOP	LAMINATO COME TOP	IMPIALLACCATO	IMPIALLACCATO
											FASCIA A	FASCIA B
<p><b>colonna H 204/216 P.14,2 sospeso con 6 ripiani legno</b></p> <p><b>N.B.: si effettuano fuori misura solo in larghezza per gli stessi considerare prezzo dell'elemento di misura immediatamente superiore.</b></p> <p>H 204/216 D.14.2 suspended column with 6 wooden shelves</p> <p>Note: they are made out of size only in width for the same consider the price of the element of the immediately larger size.</p> 												
	H 204 L 60	086TK3LS60										
	<b>maggiorazione luce</b> surcharge light											
	H 204 L 75	086TK3LS75										
	<b>maggiorazione luce</b> surcharge light											
	H 204 L 90	086TK3LS90										
	<b>maggiorazione luce</b> surcharge light											
	H 216 L 60	086TK3LU60										
	<b>maggiorazione luce</b> surcharge light											
	H 216 L 75	086TK3LU75										
	<b>maggiorazione luce</b> surcharge light											
	H 216 L 90	086TK3LU90										
	<b>maggiorazione luce</b> surcharge light											

# SISTEMA D'ARREDO "TIEKO"

"TIEKO" FURNISHING SYSTEM

GRUPPO LUBE

P 14,2

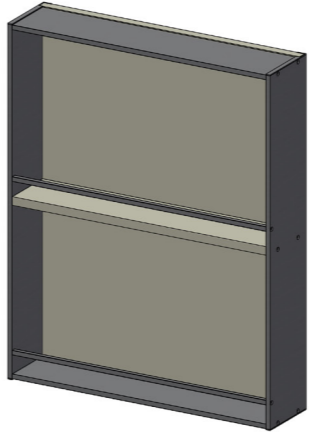
	COD.	MELAMINICI	MATHERA PET IMMAGINA	WOOD	FENIX	LACCATO UV	LACCATO OPACO	LACCATO SUPER OPACO	LACCATO COME TOP	LAMINATO COME TOP	IMPIALLACCATO	IMPIALLACCATO
											FASCIA A	FASCIA B
<p><b>modulo retro isola/ penisola sospeso P.14,2 con ripiano legno</b></p> <p><b>N.B.: si effettuano fuori misura solo in larghezza per gli stessi considerare prezzo dell'elemento di misura immediatamente superiore.</b></p> <p><b>Per il fissaggio di questo modulo nella base alla quale andrà contrapposto, dovrà essere inserito tassativamente un pannello di finitura posteriore in nobilitato o come anta.</b></p> <p>suspended island/peninsula back module D.14.2 with wooden shelf</p> <p>Note: they are made out of size only in width for the same consider the price of the element of the immediately higher size.</p> <p>To fix this module in the base to which it will be placed, a rear finishing panel in melamine or as a door must be inserted.</p> 												
	H 72 L 60	086TK3LK60										
	<b>maggiorazione luce</b> surcharge light											
	H 75 L 60	086TK3LL60										
	<b>maggiorazione luce</b> surcharge light											
	H 84 L 60	086TK3LM60										
	<b>maggiorazione luce</b> surcharge light											
	H 72 L 65	086TK3LK65										
	<b>maggiorazione luce</b> surcharge light											
	H 75 L 65	086TK3LL65										
	<b>maggiorazione luce</b> surcharge light											
	H 84 L 65	086TK3LM65										
	<b>maggiorazione luce</b> surcharge light											
	H 72 L 75	086TK3LK75										
	<b>maggiorazione luce</b> surcharge light											
	H 75 L 75	086TK3LL75										
	<b>maggiorazione luce</b> surcharge light											
	H 84 L 75	086TK3LM75										
	<b>maggiorazione luce</b> surcharge light											
	H 72 L 90	086TK3LK90										
	<b>maggiorazione luce</b> surcharge light											
	H 75 L 90	086TK3LL90										
	<b>maggiorazione luce</b> surcharge light											
	H 84 L 90	086TK3LM90										
	<b>maggiorazione luce</b> surcharge light											
	H 72 L 110	086TK3LK93										
	<b>maggiorazione luce</b> surcharge light											
	H 75 L 110	086TK3LL93										
	<b>maggiorazione luce</b> surcharge light											
	H 84 L 110	086TK3LM93										
	<b>maggiorazione luce</b> surcharge light											

# SISTEMA D'ARREDO "TIEKO"

"TIEKO" FURNISHING SYSTEM

GRUPPO LUBE

P 14,2

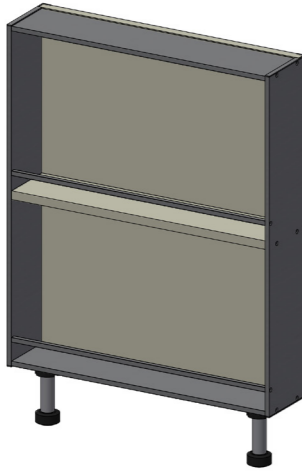
		MELAMINICI	MATHERIA PET IMMAGINA	WOOD	FENIX	LACCATO UV	LACCATO OPACO	LACCATO SUPER OPACO	LACCATO COME TOP	LAMINATO COME TOP	IMPALLACCATO	IMPALLACCATO
	COD.										FASCIA A	FASCIA B
<p><b>modulo retro isola/ penisola con piedini P.14,2 con ripiano legno</b></p> <p><b>N.B.: si effettuano fuori misura solo in larghezza per gli stessi considerare prezzo dell'elemento di misura immediatamente superiore.</b></p> <p>island/peninsula back module with feet D.14.2 with wooden shelf</p> <p>Note: they are made out of size only in width for the same consider the price of the element of the immediately larger size.</p>  <p><b>N.B.: per il fissaggio degli elementi retro isola/penisola, predisporre sempre le basi alle quali vanno contrapposti, con pannello di finitura posteriore colore cassa o come anta.</b></p> <p>Note: to fix the elements back of the island/peninsula, always prepare the bases to which they will be placed, with a rear finishing panel in the same color as the door.</p>	H 72 L 60	086TK1LK60										
	H 75 L 60	086TK1LL60										
	H 84 L 60	086TK1LM60										
	<b>maggiorazione luce</b> surcharge light											
	H 72 L 65	086TK1LK65										
	H 75 L 65	086TK1LL65										
	H 84 L 65	086TK1LM65										
	<b>maggiorazione luce</b> surcharge light											
	H 72 L 75	086TK1LK75										
	H 75 L 75	086TK1LL75										
	H 84 L 75	086TK1LM75										
	<b>maggiorazione luce</b> surcharge light											
	H 72 L 90	086TK1LK90										
	H 75 L 90	086TK1LL90										
	H 84 L 90	086TK1LM90										
	<b>maggiorazione luce</b> surcharge light											
	H 72 L 110	086TK1LK93										
	H 75 L 110	086TK1LL93										
	H 84 L 110	086TK1LM93										
	<b>maggiorazione luce</b> surcharge light											



**RETROTOP "TIEKO" PER BASI H 75 ZOCCOLO H 13 CON GOLA**  
"TIEKO" RETROTOP FOR BASE UNITS H 75 PLINTH H 13 WITH GROOVE

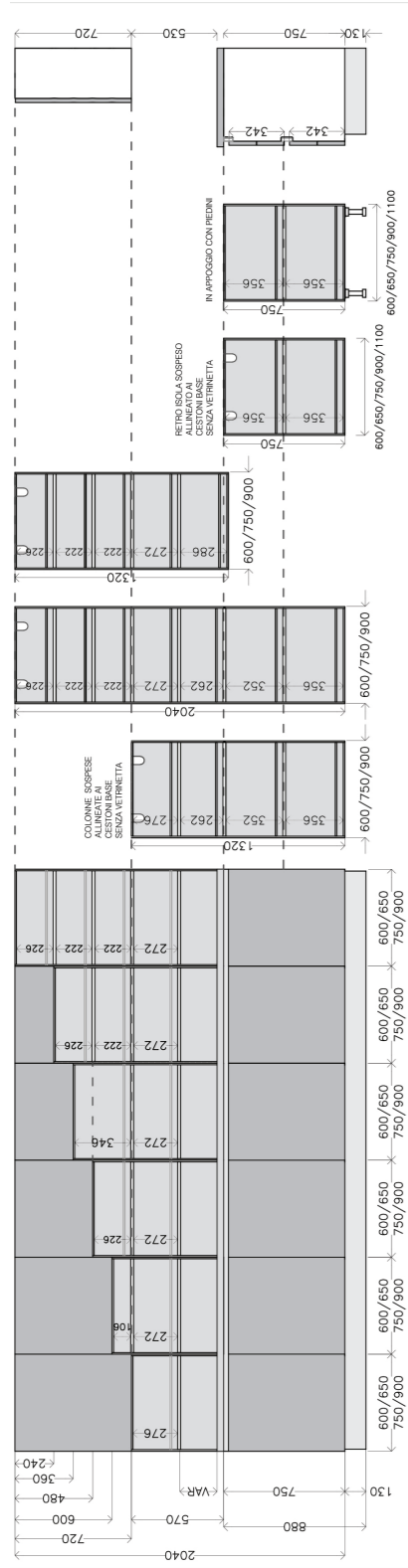

**RETROTOP "TIEKO" PER BASI H 72 ZOCCOLO H 13 SENZA GOLA**  
"TIEKO" RETROTOP FOR BASES H 72 PLINTHS H 13 WITHOUT GROOVE

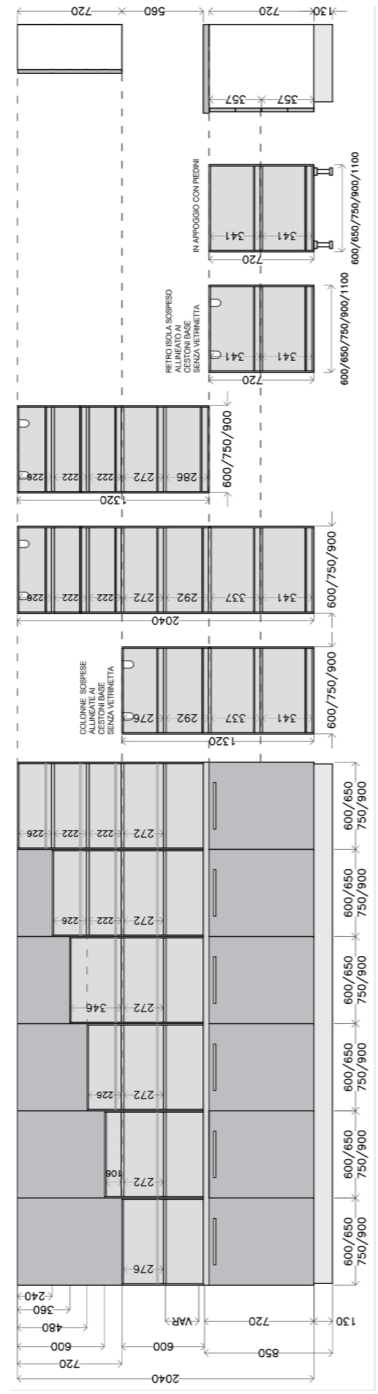

**RETROTOP "TIEKO" PER BASI H 84 ZOCCOLO H 6 CON GOLA**  
"TIEKO" RETROTOP FOR BASE UNITS H84 PLINTH H 6 WITH GROOVE

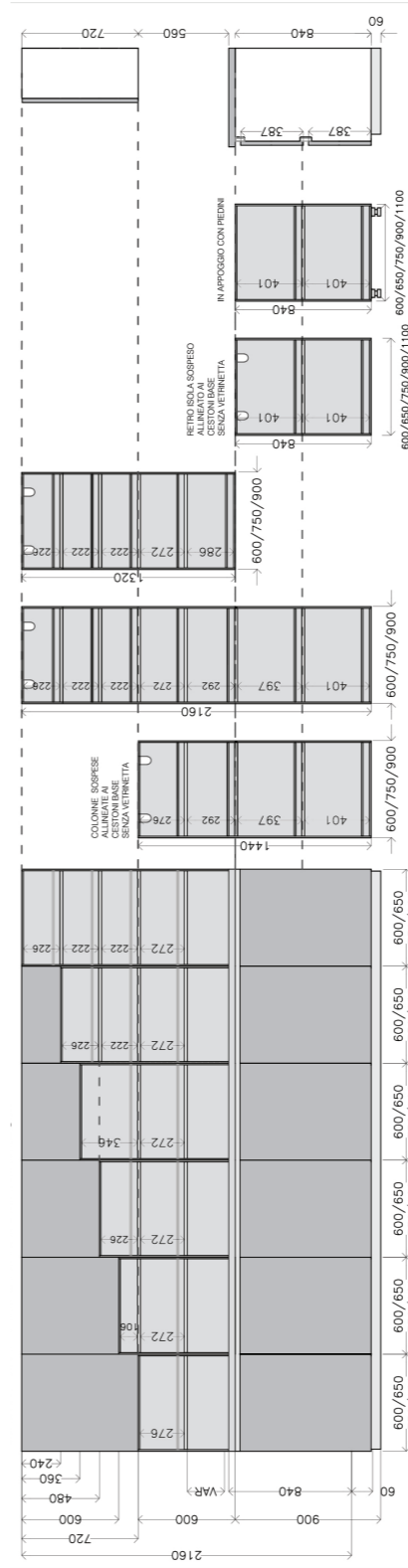

**RETROTOP "TIEKO" PER BASI H 84 ZOCCOLO H 6 SENZA GOLA**  
"TIEKO" RETROTOP FOR BASES H 84 PLINTHS H 6 WITHOUT GROOVE

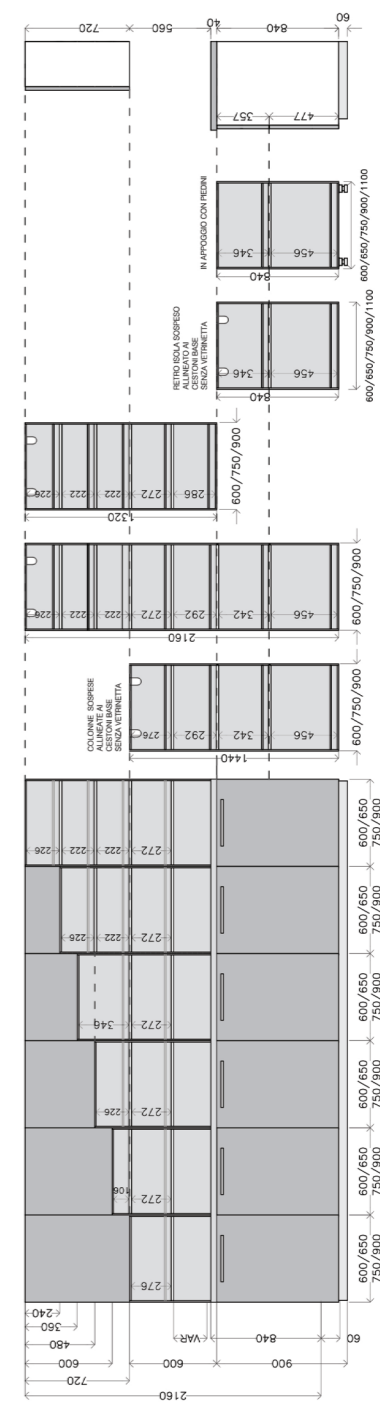

STRUTTURA ALLUMINIO CON VETRINA SCORREVOLE  
E RIPIANI ALLUMINIO, SCHIENA NELLE FINITURE INCLUSE  
A LISTINO CON E SENZA LUCI

ALUMINUM STRUCTURE WITH SLIDING DISPLAY  
AND ALUMINUM SHELVES, BACK PANEL IN THE FINISHES INCLUDED  
IN THE PRICE LIST WITH AND WITHOUT LIGHTS



# SISTEMA D'ARREDO "TIEKO"

"TIEKO" FURNISHING SYSTEM

GRUPPO LUBE

P 14,2

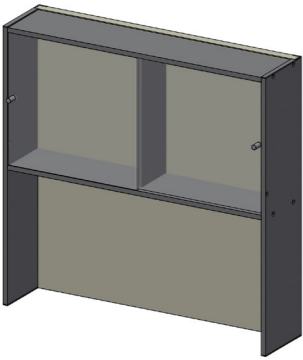
	COD.	MELAMINICI	MATHERA PET IMMAGINA	WOOD	FENIX	LACCATO UV	LACCATO OPACO	LACCATO SUPER OPACO	LACCATO COME TOP	LAMINATO COME TOP	IMPIALLACCATO	IMPIALLACCATO
											FASCIA A	FASCIA B
<p><b>modulo P.14,2 in appoggio, con vetrina scorrevole</b>  <b>N.B.: non si effettuano fuori misura</b>                      P.14.2 module supported, with sliding display case                      Note: they are not made out of size</p> 												
<p><b>L 60</b>                      da H 53 a H 58,8  <b>maggiorazione luce</b>                      surcharge light</p>	086TK2VA60											
<p><b>L 65</b>                      da H 53 a H 58,8  <b>maggiorazione luce</b>                      surcharge light</p>	086TK2VA65											
<p><b>L 75</b>                      da H 53 a H 58,8  <b>maggiorazione luce</b>                      surcharge light</p>	086TK2VA75											
<p><b>L 90</b>                      da H 53 a H 58,8  <b>maggiorazione luce</b>                      surcharge light</p>	086TK2VA90											
<p><b>maggiorazione vetro cannettato</b>                      per tutte le misure                      ribbed glass surcharge                      for all sizes</p>												

# SISTEMA D'ARREDO "TIEKO"

"TIEKO" FURNISHING SYSTEM

GRUPPO LUBE

P 14,2

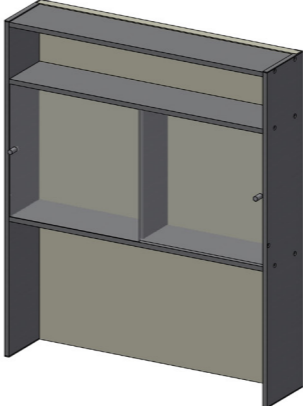
	COD.	MELAMINICI	MATHERA PET IMMAGINA	WOOD	FENIX	LACCATO UV	LACCATO OPACO	LACCATO SUPER OPACO	LACCATO COME TOP	LAMINATO COME TOP	IMPIALLACCATO	IMPIALLACCATO
											FASCIA A	FASCIA B
<p><b>modulo P.14,2 in appoggio, con vetrina scorrevole</b>  <b>N.B.: non si effettuano fuori misura</b>                      P.14.2 module supported, with sliding display case                      Note: they are not made out of size</p> 												
<p><b>L 60</b>                      da H 65 a H 70,8  <b>maggiorazione luce</b>                      surcharge light</p>	086TK2VB60											
<p><b>L 65</b>                      da H 65 a H 70,8  <b>maggiorazione luce</b>                      surcharge light</p>	086TK2VB65											
<p><b>L 75</b>                      da H 65 a H 70,8  <b>maggiorazione luce</b>                      surcharge light</p>	086TK2VB75											
<p><b>L 90</b>                      da H 65 a H 70,8  <b>maggiorazione luce</b>                      surcharge light</p>	086TK2VB90											
<p><b>maggiorazione vetro cannettato</b>                      per tutte le misure                      ribbed glass surcharge                      for all sizes</p>												

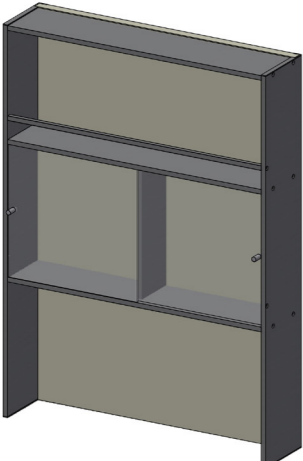
	COD.	MELAMINICI	MATHERA PET IMMAGINA	WOOD	FENIX	LACCATO UV	LACCATO OPACO	LACCATO SUPER OPACO	LACCATO COME TOP	LAMINATO COME TOP	IMPIALLACCIATO	IMPIALLACCIATO
											FASCIA A	FASCIA B
<p>modulo P.14,2 in appoggio, con vetrina scorrevole</p> <p><b>N.B.: non si effettuano fuori misura</b> P.14.2 module supported, with sliding display case <i>Note: they are not made out of size</i></p> 												
<p><b>L 60</b> da H 77 a H 82,8 <b>maggiorazione luce</b> surcharge light</p>	086TK2VC60											
<p><b>L 65</b> da H 77 a H 82,8 <b>maggiorazione luce</b> surcharge light</p>	086TK2VC65											
<p><b>L 75</b> da H 77 a H 82,8 <b>maggiorazione luce</b> surcharge light</p>	086TK2VC75											
<p><b>L 90</b> da H 77 a H 82,8 <b>maggiorazione luce</b> surcharge light</p>	086TK2VC90											
<p><b>maggiorazione vetro cannettato</b> <b>per tutte le misure</b> ribbed glass surcharge for all sizes</p>												

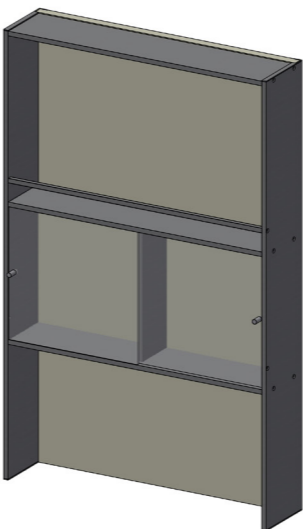
	COD.	MELAMINICI	MATHERA PET IMMAGINA	WOOD	FENIX	LACCATO UV	LACCATO OPACO	LACCATO SUPER OPACO	LACCATO COME TOP	LAMINATO COME TOP	IMPIALLACCIATO	IMPIALLACCIATO
											FASCIA A	FASCIA B
<p>modulo P.14,2 in appoggio, con vetrina scorrevole</p> <p><b>N.B.: non si effettuano fuori misura</b> P.14.2 module supported, with sliding display case <i>Note: they are not made out of size</i></p> 												
<p><b>L 60</b> da H 89 a H 94,8 <b>maggiorazione luce</b> surcharge light</p>	086TK2VD60											
<p><b>L 65</b> da H 89 a H 94,8 <b>maggiorazione luce</b> surcharge light</p>	086TK2VD65											
<p><b>L 75</b> da H 89 a H 94,8 <b>maggiorazione luce</b> surcharge light</p>	086TK2VD75											
<p><b>L 90</b> da H 89 a H 94,8 <b>maggiorazione luce</b> surcharge light</p>	086TK2VD90											
<p><b>maggiorazione vetro cannettato</b> <b>per tutte le misure</b> ribbed glass surcharge for all sizes</p>												

# SISTEMA D'ARREDO "TIEKO"

"TIEKO" FURNISHING SYSTEM

GRUPPO LUBE

P 14,2

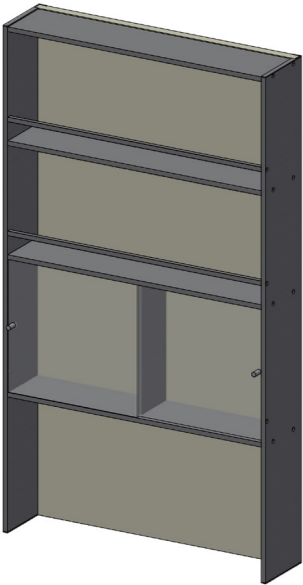
	COD.	MELAMINICI	MATHERA PET IMMAGINA	WOOD	FENIX	LACCATO UV	LACCATO OPACO	LACCATO SUPER OPACO	LACCATO COME TOP	LAMINATO COME TOP	IMPIALLACCATO	IMPIALLACCATO
											FASCIA A	FASCIA B
<p><b>modulo P.14,2 in appoggio con ripiano alluminio e 1 vetrina scorrevole</b></p> <p><b>N.B.: non si effettuano fuori misura</b> module D.14.2 supported with aluminum shelf and 1 sliding display case <i>Note: they are not made out of size</i></p> 												
<p><b>L 60</b> da H 101 a H 106,8 <b>maggiorazione luce</b> surcharge light</p>	086TK2VE60											
<p><b>L 65</b> da H 101 a H 106,8 <b>maggiorazione luce</b> surcharge light</p>	086TK2VE65											
<p><b>L 75</b> da H 101 a H 106,8 <b>maggiorazione luce</b> surcharge light</p>	086TK2VE75											
<p><b>L 90</b> da H 101 a H 106,8 <b>maggiorazione luce</b> surcharge light</p>	086TK2VE90											
<p><b>maggiorazione vetro cannettato per tutte le misure</b> ribbed glass surcharge for all sizes</p>												

# SISTEMA D'ARREDO "TIEKO"

"TIEKO" FURNISHING SYSTEM

GRUPPO LUBE

P 14,2

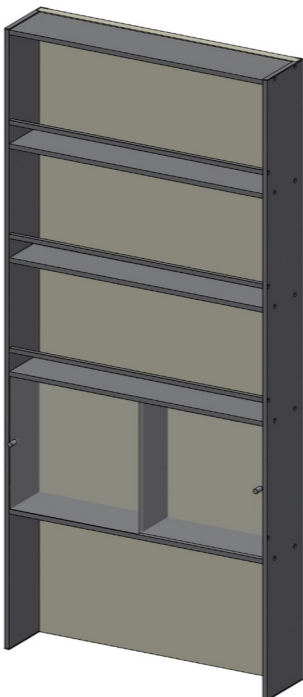
	COD.	MELAMINICI	MATHERA PET IMMAGINA	WOOD	FENIX	LACCATO UV	LACCATO OPACO	LACCATO SUPER OPACO	LACCATO COME TOP	LAMINATO COME TOP	IMPIALLACCATO	IMPIALLACCATO
											FASCIA A	FASCIA B
<p><b>modulo P.14,2 in appoggio con 2 ripiani alluminio e 1 vetrina scorrevole</b></p> <p><b>N.B.: non si effettuano fuori misura</b> module D.14.2 supported with 2 aluminum shelves and 1 sliding display case <i>Note: they are not made out of size</i></p> 												
<p><b>L 60</b> da H 125 a H 130,8 <b>maggiorazione luce</b> surcharge light</p>	086TK2VF60											
<p><b>L 65</b> da H 125 a H 130,8 <b>maggiorazione luce</b> surcharge light</p>	086TK2VF65											
<p><b>L 75</b> da H 125 a H 130,8 <b>maggiorazione luce</b> surcharge light</p>	086TK2VF75											
<p><b>L 90</b> da H 125 a H 130,8 <b>maggiorazione luce</b> surcharge light</p>	086TK2VF90											
<p><b>maggiorazione vetro cannettato per tutte le misure</b> ribbed glass surcharge for all sizes</p>												



# SISTEMA D'ARREDO "TIEKO"

"TIEKO" FURNISHING SYSTEM

GRUPPO LUBE

P 14,2

	COD.	MELAMINICI	MATHERA PET IMMAGINA	WOOD	FENIX	LACCATO UV	LACCATO OPACO	LACCATO SUPER OPACO	LACCATO COME TOP	LAMINATO COME TOP	IMPIALLACCATO	IMPIALLACCATO
											FASCIA A	FASCIA B
<b>modulo H 132 P.14,2 sospeso con 2 ripiani alluminio, 1 vetrina scorrevole in basso</b> <b>N.B.: non si effettuano fuori misura</b> module H 132 D.14.2 suspended with 2 shelves aluminum, 1 sliding display case at the bottom Note: they are not made out of size												
<b>H 132 L 60</b> maggiorazione luce surcharge light	086TK3VQ60											
<b>H 132 L 75</b> maggiorazione luce surcharge light	086TK3VQ75											
<b>H 132 L 90</b> maggiorazione luce surcharge light	086TK3VQ90											
maggiorazione vetro cannettato per tutte le misure ribbed glass surcharge for all sizes												

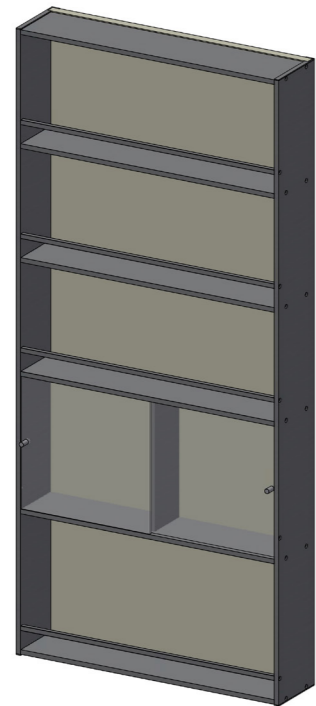

# SISTEMA D'ARREDO "TIEKO"

"TIEKO" FURNISHING SYSTEM

GRUPPO LUBE

P 14,2

	COD.	MELAMINICI	MATHERA PET IMMAGINA	WOOD	FENIX	LACCATO UV	LACCATO OPACO	LACCATO SUPER OPACO	LACCATO COME TOP	LAMINATO COME TOP	IMPIALLACCATO	IMPIALLACCATO
											FASCIA A	FASCIA B
<b>colonna H 132/144 P.14,2 sospeso con 2 ripiani alluminio, 1 vetrina scorrevole in alto</b> <b>N.B.: non si effettuano fuori misura</b> column H 132/144 D.14.2 suspended with 2 aluminum shelves, 1 sliding display case at the top Note: they are not made out of size												
<b>H 132 L 60</b> maggiorazione luce surcharge light	086TK3VP60											
<b>H 132 L 75</b> maggiorazione luce surcharge light	086TK3VP75											
<b>H 132 L 90</b> maggiorazione luce surcharge light	086TK3VP90											
<b>H 144 L 60</b> maggiorazione luce surcharge light	086TK3VR60											
<b>H 144 L 75</b> maggiorazione luce surcharge light	086TK3VR75											
<b>H 144 L 90</b> maggiorazione luce surcharge light	086TK3VR90											
maggiorazione vetro cannettato per tutte le misure ribbed glass surcharge for all sizes												

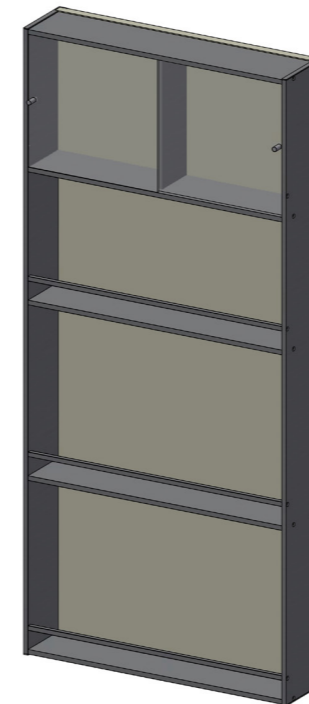

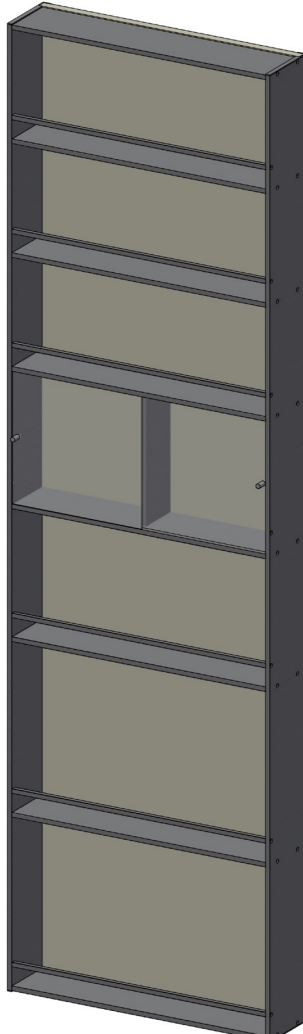
	COD.	MELAMINICI	MATHERA PET IMMAGINA	WOOD	FENIX	LACCATO UV	LACCATO OPACO	LACCATO SUPER OPACO	LACCATO COME TOP	LAMINATO COME TOP	IMPIALLACCATO	IMPIALLACCATO
											FASCIA A	FASCIA B
<p><b>colonna H 204/216 P.14,2 sospeso</b>  <b>4 ripiani alluminio, 1 vetrina scorrevole</b>  <b>N.B.: non si effettuano fuori misura</b>                      column H 204/216 D.14.2 suspended                      4 aluminum shelves, 1 sliding display case  <i>Note: they are not made out of size</i></p> 												
<p><b>H 204 L 60</b> 086TK3VS60</p> <p><b>maggiorazione luce</b> surcharge light</p> <p><b>H 204 L 75</b> 086TK3VS75</p> <p><b>maggiorazione luce</b> surcharge light</p> <p><b>H 204 L 90</b> 086TK3VS90</p> <p><b>maggiorazione luce</b> surcharge light</p> <p><b>H 216 L 60</b> 086TK3VU60</p> <p><b>maggiorazione luce</b> surcharge light</p> <p><b>H 216 L 75</b> 086TK3VU75</p> <p><b>maggiorazione luce</b> surcharge light</p> <p><b>H 216 L 90</b> 086TK3VU90</p> <p><b>maggiorazione luce</b> surcharge light</p> <p><b>maggiorazione vetro cannettato</b> per tutte le misure ribbed glass surcharge for all sizes</p>												

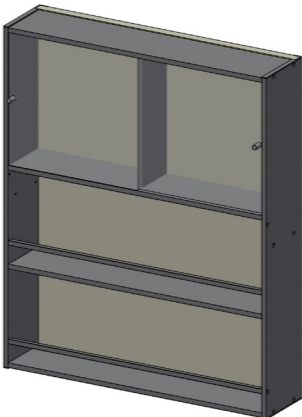
	COD.	MELAMINICI	MATHERA PET IMMAGINA	WOOD	FENIX	LACCATO UV	LACCATO OPACO	LACCATO SUPER OPACO	LACCATO COME TOP	LAMINATO COME TOP	IMPIALLACCATO	IMPIALLACCATO
											FASCIA A	FASCIA B
<p><b>modulo retro isola/ penisola sospeso P.14,2</b>  <b>con ripiano alluminio, 1 vetrina scorrevole</b>  <b>N.B.: non si effettuano fuori misura</b>                      suspended island/peninsula back module D.14.2                      with aluminum shelf, 1 sliding display case  <i>Note: they are not made out of size</i></p> 												
<p><b>N.B.: per il fissaggio degli elementi</b>  <b>retro isola/penisola, predisporre sempre</b>  <b>le basi alle quali vanno contrapposti,</b>  <b>con pannello di finitura posteriore</b>  <b>colore cassa o come anta.</b>                      Note: to fix the elements                      back of the island/peninsula, always prepare                      the bases to which they will be placed,                      with a rear finishing panel                      in the same color as the door.</p> <p><b>H 72 L 60</b> 086TK3VK60</p> <p><b>H 75 L 60</b> 086TK3VL60</p> <p><b>H 84 L 60</b> 086TK3VM60</p> <p><b>maggiorazione luce</b> surcharge light</p> <p><b>H 72 L 65</b> 086TK3VK65</p> <p><b>H 75 L 65</b> 086TK3VL65</p> <p><b>H 84 L 65</b> 086TK3VM65</p> <p><b>maggiorazione luce</b> surcharge light</p> <p><b>H 72 L 75</b> 086TK3VK75</p> <p><b>H 75 L 75</b> 086TK3VL75</p> <p><b>H 84 L 75</b> 086TK3VM75</p> <p><b>maggiorazione luce</b> surcharge light</p> <p><b>H 72 L 90</b> 086TK3VK90</p> <p><b>H 75 L 90</b> 086TK3VL90</p> <p><b>H 84 L 90</b> 086TK3VM90</p> <p><b>maggiorazione luce</b> surcharge light</p> <p><b>maggiorazione vetro cannettato</b> per tutte le misure ribbed glass surcharge for all sizes</p>												

# SISTEMA D'ARREDO "TIEKO"

"TIEKO" FURNISHING SYSTEM

GRUPPO LUBE

P 14,2

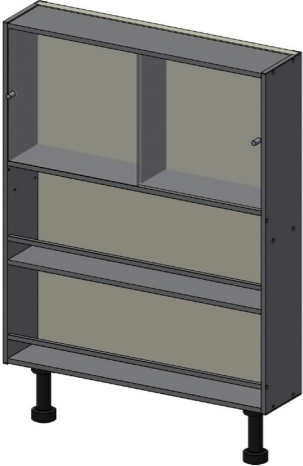
		MELAMINICI	MATHERA PET IMMAGINA	WOOD	FENIX	LACCATO UV	LACCATO OPACO	LACCATO SUPER OPACO	LACCATO COME TOP	LAMINATO COME TOP	IMPALLACCATO	IMPALLACCATO
	COD.										FASCIA A	FASCIA B
<p><b>modulo retro isola/ penisola con piedini P.14,2</b>  <b>1 ripiano alluminio e vetrina scorrevole</b>  <b>N.B.: non si effettuano fuori misura</b>                      island/peninsula back module with feet D.14.2                      1 aluminum shelf and sliding display case                      Note: they are not made out of size</p> 												
<p><b>N.B.: per il fissaggio degli elementi retro isola/penisola, predisporre sempre le basi alle quali vanno contrapposti, con pannello di finitura posteriore colore cassa o come anta.</b>                      Note: to fix the elements back of the island/peninsula, always prepare the bases to which they will be placed, with a rear finishing panel in the same color as the door.</p> <p><b>maggiorazione luce</b>                      surcharge light</p> <p>H 72 L 60 086TK1VK60</p> <p>H 75 L 60 086TK1VL60</p> <p>H 84 L 60 086TK1VM60</p> <p><b>maggiorazione luce</b>                      surcharge light</p> <p>H 72 L 65 086TK1VK65</p> <p>H 75 L 65 086TK1VL65</p> <p>H 84 L 65 086TK1VM65</p> <p><b>maggiorazione luce</b>                      surcharge light</p> <p>H 72 L 75 086TK1VK75</p> <p>H 75 L 75 086TK1VL75</p> <p>H 84 L 75 086TK1VM75</p> <p><b>maggiorazione luce</b>                      surcharge light</p> <p>H 72 L 90 086TK1VK90</p> <p>H 75 L 90 086TK1VL90</p> <p>H 84 L 90 086TK1VM90</p> <p><b>maggiorazione luce</b>                      surcharge light</p> <p><b>maggiorazione vetro cannettato per tutte le misure</b>                      ribbed glass surcharge for all sizes</p>												



**RETROTOP "TIEKO" PER BASI H 75 ZOCCOLO H 13 CON GOLA**  
"TIEKO" RETROTOP FOR BASE UNITS H 75 PLINTH H 13 WITH GROOVE

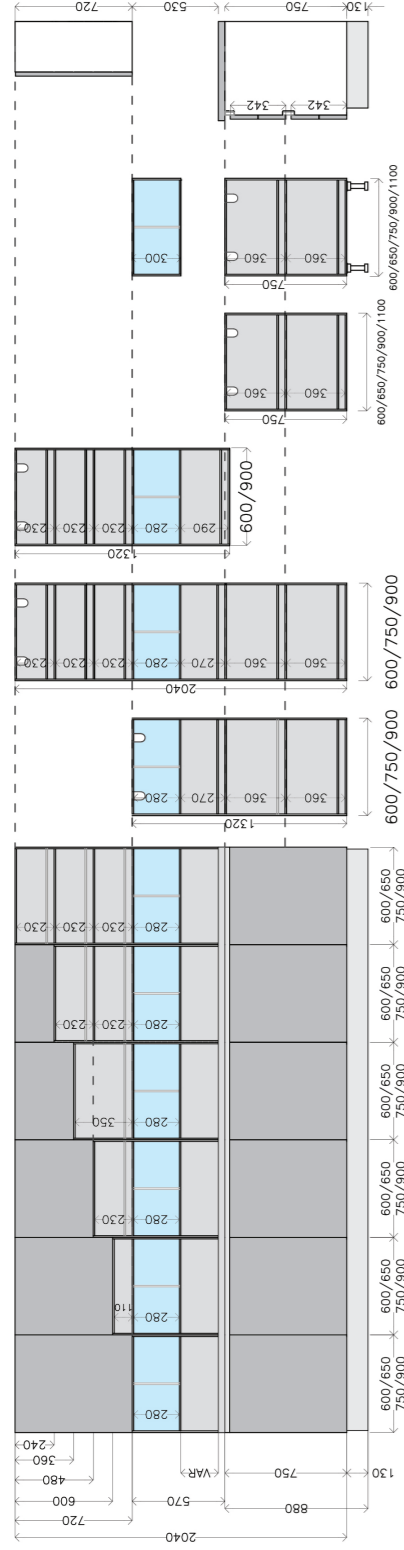

**RETROTOP "TIEKO" PER BASI H 72 ZOCCOLO H 13 SENZA GOLA**  
"TIEKO" RETROTOP FOR BASES H 72 PLINTHS H 13 WITHOUT GROOVE

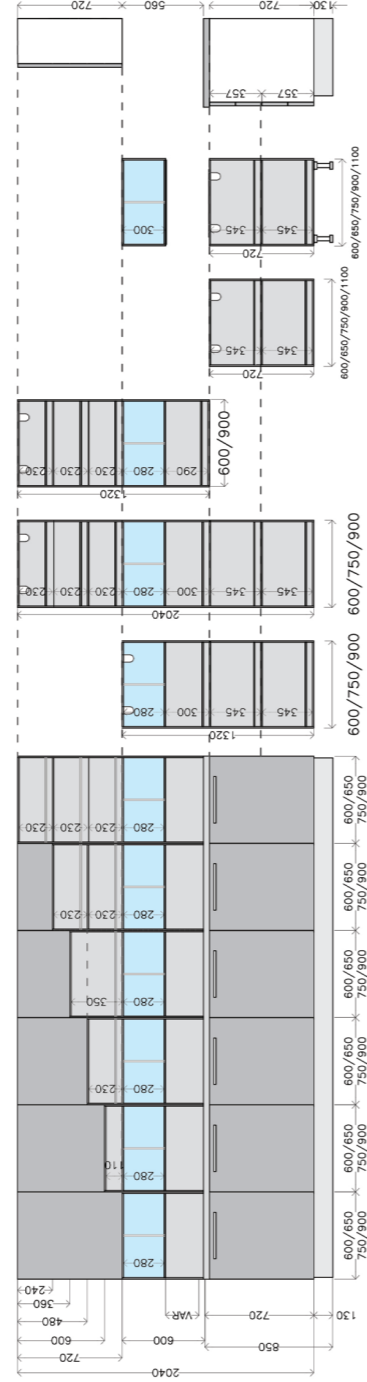

**RETROTOP "TIEKO" PER BASI H 84 ZOCCOLO H 6 CON GOLA**  
"TIEKO" RETROTOP FOR BASE UNITS H84 PLINTH H 6 WITH GROOVE

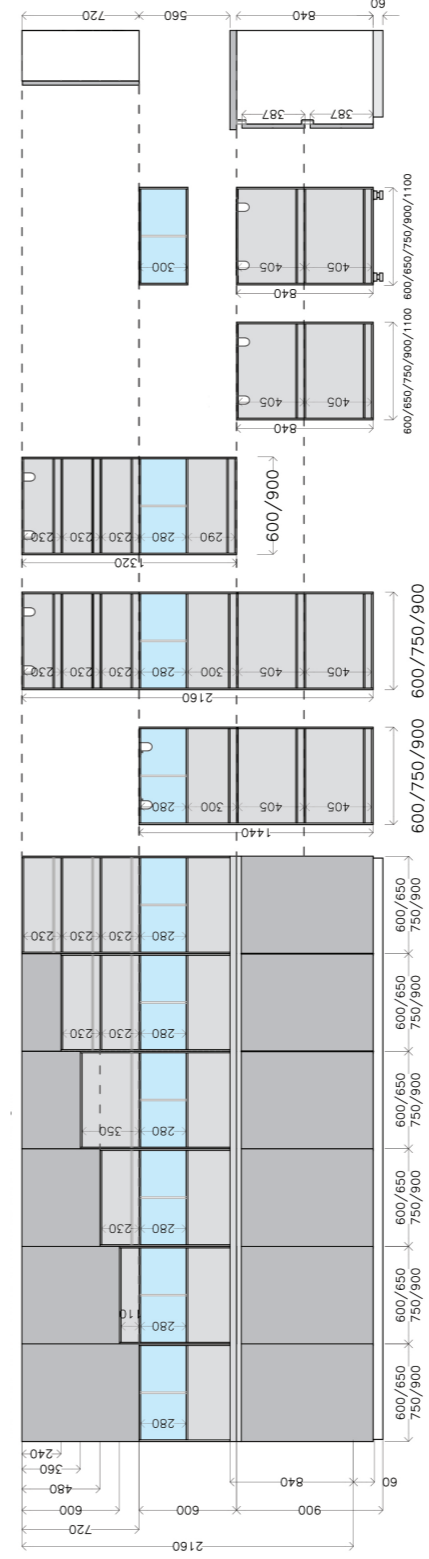

**RETROTOP "TIEKO" PER BASI H 84 ZOCCOLO H 6 SENZA GOLA**  
"TIEKO" RETROTOP FOR BASES H 84 PLINTHS H 6 WITHOUT GROOVE

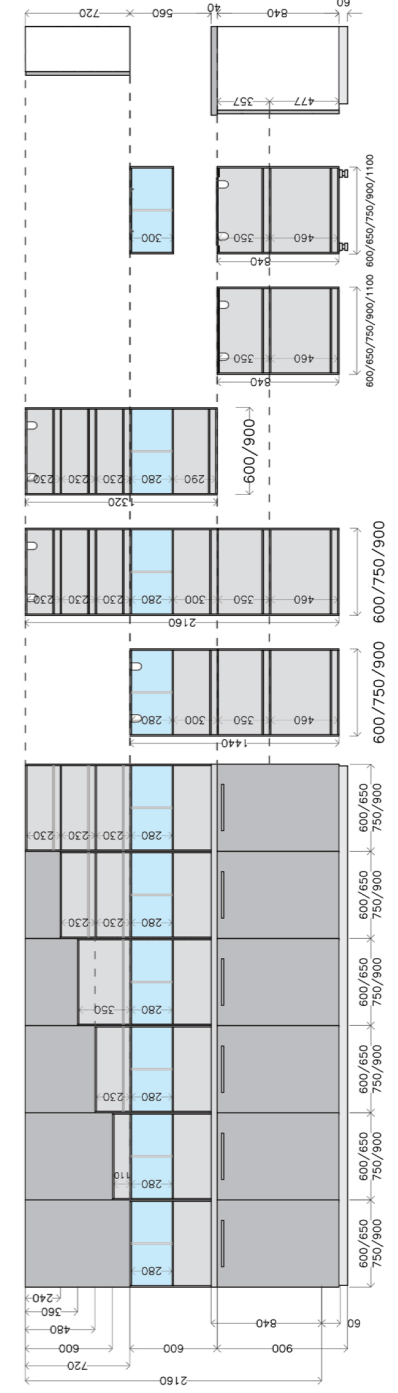

STRUTTURA ALLUMINIO CON VETRINA ANTE SCORREVOLI  
SCHIENA E RIPIANI LEGNO, NELLE FINITURE INSERITE  
A LISTINO CON E SENZA LUCI

ALUMINUM STRUCTURE WITH DISPLAY CABINET SLIDING DOORS  
BACK PANEL AND WOODEN SHELVES, IN THE FINISHES INCLUDED  
ON THE PRICE LIST WITH AND WITHOUT LIGHTS



# SISTEMA D'ARREDO "TIEKO"

"TIEKO" FURNISHING SYSTEM

GRUPPO LUBE

P 14,2

	COD.	MELAMINICI	MATHERA PET IMMAGINA	WOOD	FENIX	LACCATO UV	LACCATO OPACO	LACCATO SUPER OPACO	LACCATO COME TOP	LAMINATO COME TOP	IMPIALLACCATO	IMPIALLACCATO	
											FASCIA A	FASCIA B	
<p>modulo P.14,2 in appoggio con ripiano legno e vetrina scorrevole</p> <p><b>N.B.: non si effettuano fuori misura</b></p> <p>module D.14.2 supported with wooden shelf and sliding display case</p> <p>Note: they are not made out of size</p>													
<p><b>L 60</b> da H 101 a H 106,8 <b>maggiorazione luce</b> surcharge light</p> <p><b>L 65</b> da H 101 a H 106,8 <b>maggiorazione luce</b> surcharge light</p> <p><b>L 75</b> da H 101 a H 106,8 <b>maggiorazione luce</b> surcharge light</p> <p><b>L 90</b> da H 101 a H 106,8 <b>maggiorazione luce</b> surcharge light</p> <p><b>maggiorazione vetro cannettato</b> per tutte le misure ribbed glass surcharge for all sizes</p>	086TK2WE60												
	086TK2WE65												
	086TK2WE75												
	086TK2WE90												

# SISTEMA D'ARREDO "TIEKO"

"TIEKO" FURNISHING SYSTEM

GRUPPO LUBE

P 14,2

	COD.	MELAMINICI	MATHERA PET IMMAGINA	WOOD	FENIX	LACCATO UV	LACCATO OPACO	LACCATO SUPER OPACO	LACCATO COME TOP	LAMINATO COME TOP	IMPIALLACCATO	IMPIALLACCATO	
											FASCIA A	FASCIA B	
<p>modulo P.14,2 in appoggio con 2 ripiani legno e vetrina scorrevole</p> <p><b>N.B.: non si effettuano fuori misura</b></p> <p>module D.14.2 supported with 2 shelves wood and sliding display case</p> <p>Note: they are not made out of size</p>													
<p><b>L 60</b> da H 125 a H 130,8 <b>maggiorazione luce</b> surcharge light</p> <p><b>L 65</b> da H 125 a H 130,8 <b>maggiorazione luce</b> surcharge light</p> <p><b>L 75</b> da H 125 a H 130,8 <b>maggiorazione luce</b> surcharge light</p> <p><b>L 90</b> da H 125 a H 130,8 <b>maggiorazione luce</b> surcharge light</p> <p><b>maggiorazione vetro cannettato</b> per tutte le misure ribbed glass surcharge for all sizes</p>	086TK2WF60												
	086TK2WF65												
	086TK2WF75												
	086TK2WF90												

# SISTEMA D'ARREDO "TIEKO"

"TIEKO" FURNISHING SYSTEM

GRUPPO LUBE

P 14,2

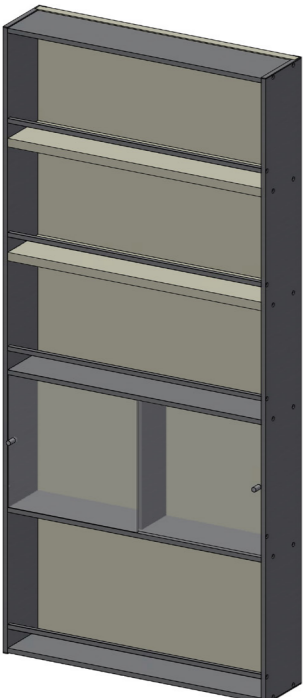
	COD.	MELAMINICI	MATHERA PET IMMAGINA	WOOD	FENIX	LACCATO UV	LACCATO OPACO	LACCATO SUPER OPACO	LACCATO COME TOP	LAMINATO COME TOP	IMPIALLACCATO	IMPIALLACCATO
											FASCIA A	FASCIA B
<b>modulo H 132 P.14,2 sospeso con 2 ripiani legno e vetrina scorrevole in basso</b> <b>N.B.: non si effettuano fuori misura</b> module H 132 D.14.2 suspended with 2 shelves wood and sliding display case at the bottom Note: they are not made out of size												
												
<b>H 132 L 60</b> 086TK3WQ60 <b>maggiorazione luce</b> surcharge light												
<b>H 132 L 75</b> 086TK3WQ75 <b>maggiorazione luce</b> surcharge light												
<b>H 132 L 90</b> 086TK3WQ90 <b>maggiorazione luce</b> surcharge light												
<b>maggiorazione vetro cannettato</b> <b>per tutte le misure</b> ribbed glass surcharge for all sizes												

# SISTEMA D'ARREDO "TIEKO"

"TIEKO" FURNISHING SYSTEM

GRUPPO LUBE

P 14,2

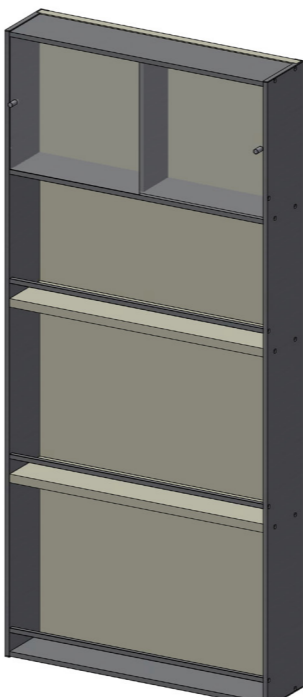
	COD.	MELAMINICI	MATHERA PET IMMAGINA	WOOD	FENIX	LACCATO UV	LACCATO OPACO	LACCATO SUPER OPACO	LACCATO COME TOP	LAMINATO COME TOP	IMPIALLACCATO	IMPIALLACCATO
											FASCIA A	FASCIA B
<b>colonna H 132/144 P.14,2 sospeso</b> <b>2 ripiani legno e vetrina scorrevole in alto</b> <b>N.B.: non si effettuano fuori misura</b> column H 132/144 D.14.2 suspended 2 wooden shelves and sliding display cabinet at the top Note: they are not made out of size												
												
<b>H 132 L 60</b> 086TK3WP60 <b>maggiorazione luce</b> surcharge light												
<b>H 132 L 75</b> 086TK3WP75 <b>maggiorazione luce</b> surcharge light												
<b>H 132 L 90</b> 086TK3WP90 <b>maggiorazione luce</b> surcharge light												
<b>H 144 L 60</b> 086TK3WR60 <b>maggiorazione luce</b> surcharge light												
<b>H 144 L 75</b> 086TK3WR75 <b>maggiorazione luce</b> surcharge light												
<b>H 144 L 90</b> 086TK3WR90 <b>maggiorazione luce</b> surcharge light												
<b>maggiorazione vetro cannettato</b> <b>per tutte le misure</b> ribbed glass surcharge for all sizes												

# SISTEMA D'ARREDO "TIEKO"

"TIEKO" FURNISHING SYSTEM

GRUPPO LUBE

P 14,2

	COD.	MELAMINICI	MATHERA PET IMMAGINA	WOOD	FENIX	LACCATO UV	LACCATO OPACO	LACCATO SUPER OPACO	LACCATO COME TOP	LAMINATO COME TOP	IMPIALLACCATO	IMPIALLACCATO
											FASCIA A	FASCIA B
<b>colonna H 204/216 P.14,2 sospeso</b> <b>4 ripiani legno e vetrina scorrevole</b> <b>N.B.: non si effettuano fuori misura</b> column H 204/216 D.14.2 suspended 4 wooden shelves and sliding display cabinet Note: they are not made out of size												
H 204 L 60 maggiorazione luce surcharge light	086TK3WS60											
H 204 L 75 maggiorazione luce surcharge light	086TK3WS75											
H 204 L 90 maggiorazione luce surcharge light	086TK3WS90											
H 216 L 60 maggiorazione luce surcharge light	086TK3WU60											
H 216 L 75 maggiorazione luce surcharge light	086TK3WU75											
H 216 L 90 maggiorazione luce surcharge light	086TK3WU90											
maggiorazione vetro cannettato per tutte le misure ribbed glass surcharge for all sizes												

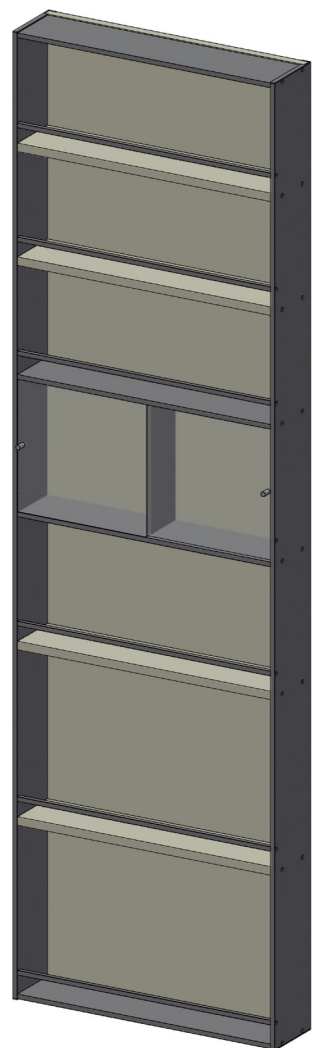

# SISTEMA D'ARREDO "TIEKO"

"TIEKO" FURNISHING SYSTEM

GRUPPO LUBE

P 14,2

	COD.	MELAMINICI	MATHERA PET IMMAGINA	WOOD	FENIX	LACCATO UV	LACCATO OPACO	LACCATO SUPER OPACO	LACCATO COME TOP	LAMINATO COME TOP	IMPIALLACCATO	IMPIALLACCATO
											FASCIA A	FASCIA B
<b>modulo retro isola/ penisola sospeso P.14,2</b> <b>1 ripiano legno e vetrina scorrevole</b> <b>N.B.: non si effettuano fuori misura</b> suspended island/peninsula back module D.14.2 1 wooden shelf and sliding display case Note: they are not made out of size												
H 72 L 60 maggiorazione luce surcharge light	086TK3WK60											
H 75 L 60 maggiorazione luce surcharge light	086TK3WL60											
H 84 L 60 maggiorazione luce surcharge light	086TK3WM60											
H 72 L 65 maggiorazione luce surcharge light	086TK3WK65											
H 75 L 65 maggiorazione luce surcharge light	086TK3WL65											
H 84 L 65 maggiorazione luce surcharge light	086TK3WM65											
H 72 L 75 maggiorazione luce surcharge light	086TK3WK75											
H 75 L 75 maggiorazione luce surcharge light	086TK3WL75											
H 84 L 75 maggiorazione luce surcharge light	086TK3WM75											
H 72 L 90 maggiorazione luce surcharge light	086TK3WK90											
H 75 L 90 maggiorazione luce surcharge light	086TK3WL90											
H 84 L 90 maggiorazione luce surcharge light	086TK3WM90											
maggiorazione vetro cannettato per tutte le misure ribbed glass surcharge for all sizes												

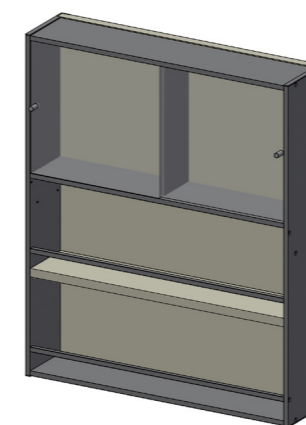

**N.B.: per il fissaggio degli elementi**  
**retro isola/penisola, predisporre sempre**  
**le basi alle quali vanno contrapposti,**  
**con pannello di finitura posteriore**  
**colore cassa o come anta.**

**Note:** to fix the elements  
 back of the island/peninsula, always prepare  
 the bases to which they will be placed,  
 with a rear finishing panel  
 in the same color as the door.



# SISTEMA D'ARREDO "TIEKO"

"TIEKO" FURNISHING SYSTEM

GRUPPO LUBE

P 14,2

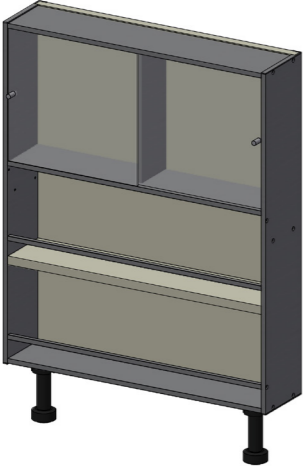
	COD.	MELAMINICI	MATHERA PET IMMAGINA	WOOD	FENIX	LACCATO UV	LACCATO OPACO	LACCATO SUPER OPACO	LACCATO COME TOP	LAMINATO	IMPIALLACCATO	IMPIALLACCATO
											FASCIA A	FASCIA B
<b>modulo retro isola/ penisola con piedini P.14,2 con ripiano legno e vetrina scorrevole</b> <b>N.B.: non si effettuano fuori misura</b> island/peninsula back module with feet D.14.2 with wooden shelf and sliding display case <i>Note: they are not made out of size</i>												
												
<b>N.B.: per il fissaggio degli elementi retro isola/penisola, predisporre sempre le basi alle quali vanno contrapposti, con pannello di finitura posteriore colore cassa o come anta.</b> Note: to fix the elements back of the island/peninsula, always prepare the bases to which they will be placed, with a rear finishing panel in the same color as the door.	H 72 L 60 086TK1WK60 H 75 L 60 086TK1WL60 H 84 L 60 086TK1WM60 maggiorazione luce surcharge light H 72 L 65 086TK1WK65 H 75 L 65 086TK1WL65 H 84 L 65 086TK1WM65 maggiorazione luce surcharge light H 72 L 75 086TK1WK75 H 75 L 75 086TK1WL75 H 84 L 75 086TK1WM75 maggiorazione luce surcharge light H 72 L 90 086TK1WK90 H 75 L 90 086TK1WL90 H 84 L 90 086TK1WM90 maggiorazione luce surcharge light maggiorazione vetro cannettato per tutte le misure ribbed glass surcharge for all sizes											



**RETROTOP "TIEKO" PER BASI H 75 ZOCCOLO H 13 CON GOLA**  
"TIEKO" RETROTOP FOR BASE UNITS H 75 PLINTH H 13 WITH GROOVE

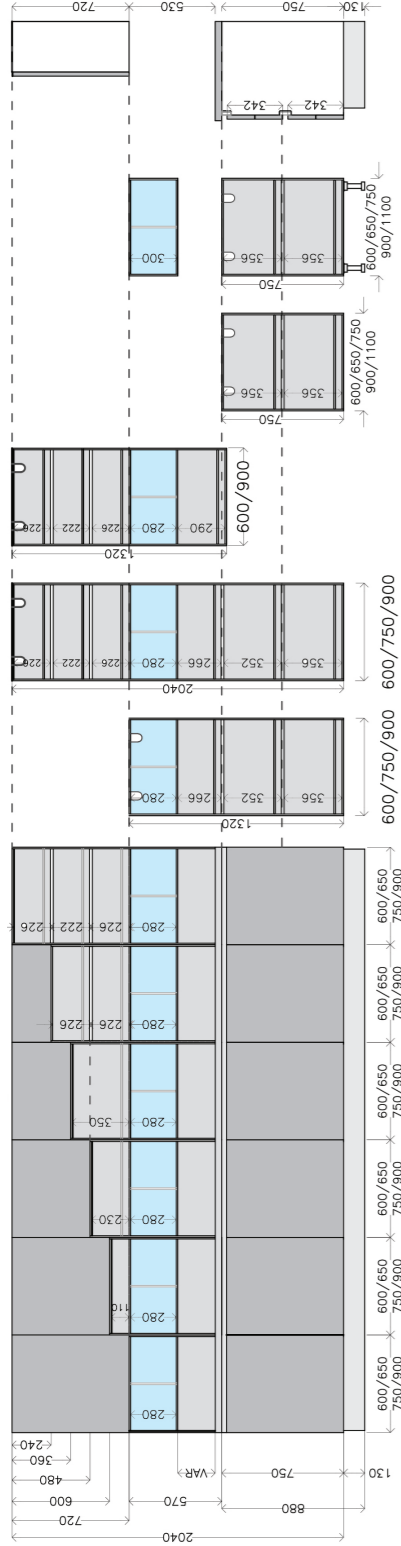

**RETROTOP "TIEKO" PER BASI H 72 ZOCCOLO H 13 SENZA GOLA**  
"TIEKO" RETROTOP FOR BASES H 72 PLINTHS H 13 WITHOUT GROOVE

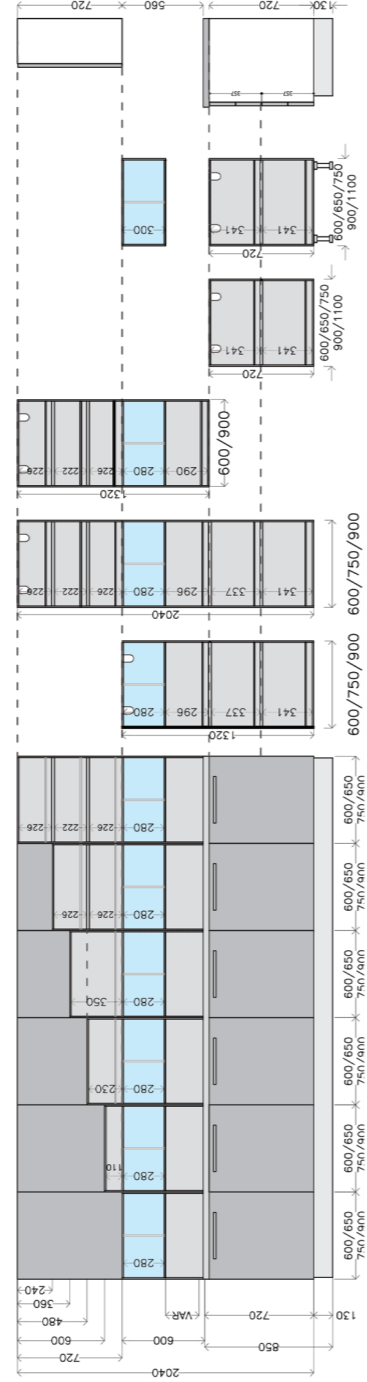

**RETROTOP "TIEKO" PER BASI H 84 ZOCCOLO H 6 CON GOLA**  
"TIEKO" RETROTOP FOR BASE UNITS H84 PLINTH H 6 WITH GROOVE



**RETROTOP "TIEKO" PER BASI H 84 ZOCCOLO H 6 SENZA GOLA**  
"TIEKO" RETROTOP FOR BASES H 84 PLINTHS H 6 WITHOUT GROOVE

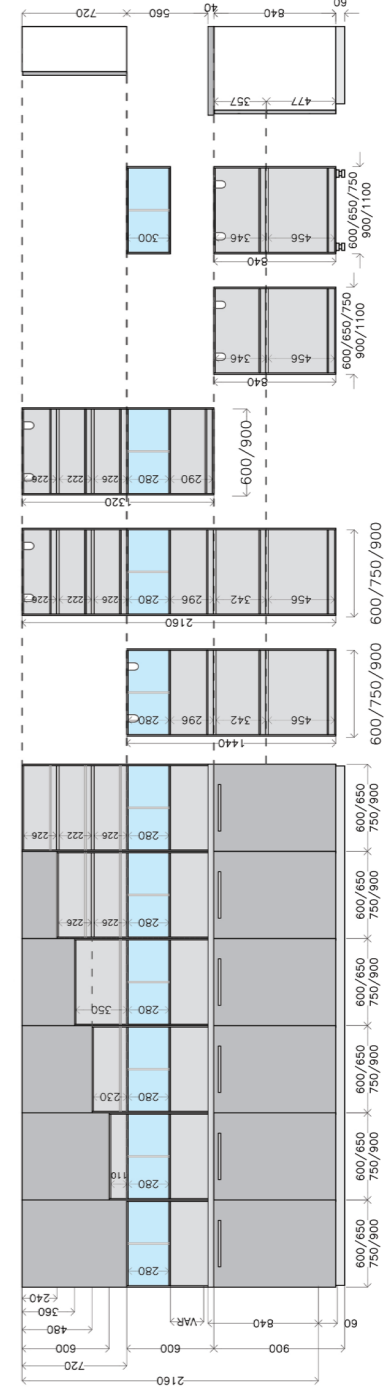

**STRUTTURA ALLUMINIO CON DOPPIA VETRINA  
SCHIENA E RIPIANI ALLUMINIO/LEGNO, NELLE FINITURE INSERITE  
A LISTINO CON E SENZA LUCI**

**ALUMINUM STRUCTURE WITH DOUBLE GLASS CABINET  
BACK PANEL AND ALUMINIUM/WOODEN SHELVES, IN THE FINISHES INCLUDED  
ON THE PRICE LIST WITH AND WITHOUT LIGHTS**

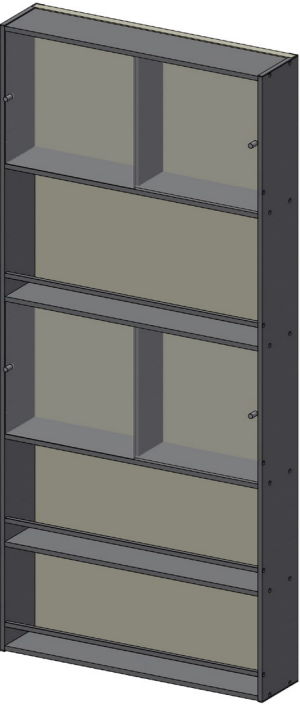

	COD.	MELAMINICI	MATHERA PET IMMAGINA	WOOD	FENIX	LACCATO UV	LACCATO OPACO	LACCATO SUPER OPACO	LACCATO COME TOP	LAMINATO COME TOP	IMPIALLACCATO	IMPIALLACCATO
											FASCIA A	FASCIA B
<p>colonna H 132/144 P.14,2 sospeso con ripiano alluminio e 2 vetrine scorrevoli</p> <p><b>N.B.: non si effettuano fuori misura</b></p> <p>column H 132/144 D.14.2 suspended with aluminium shelf and 2 sliding display cases</p> <p>Note: they are not made out of size</p>												
												
H 132 L 60	086TK3XP60											
maggiorazione luce surcharge light												
H 132 L 75	086TK3XP75											
maggiorazione luce surcharge light												
H 132 L 90	086TK3XP90											
maggiorazione luce surcharge light												
H 144 L 60	086TK3XR60											
maggiorazione luce surcharge light												
H 144 L 75	086TK3XR75											
maggiorazione luce surcharge light												
H 144 L 90	086TK3XR90											
maggiorazione luce surcharge light												
maggiorazione vetro cannettato per tutte le misure ribbed glass surcharge for all sizes												

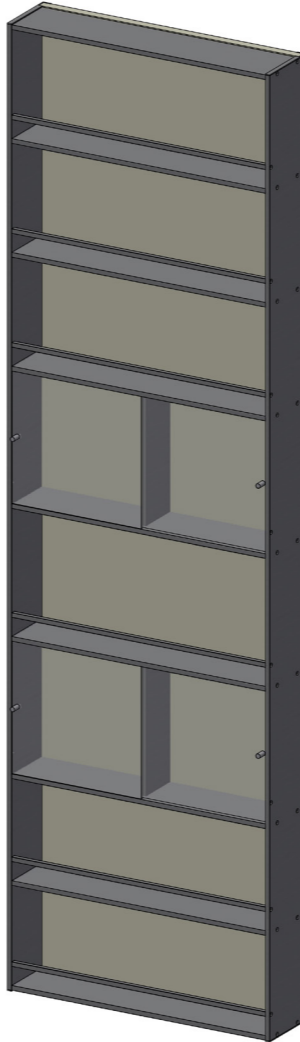
	COD.	MELAMINICI	MATHERA PET IMMAGINA	WOOD	FENIX	LACCATO UV	LACCATO OPACO	LACCATO SUPER OPACO	LACCATO COME TOP	LAMINATO COME TOP	IMPIALLACCATO	IMPIALLACCATO
											FASCIA A	FASCIA B
<p>colonna H 204/216 P.14,2 sospeso con 3 ripiani alluminio e 2 vetrine scorrevoli</p> <p><b>N.B.: non si effettuano fuori misura</b></p> <p>column H 204/216 D.14.2 suspended with 3 aluminum shelves and 2 sliding display cases</p> <p>Note: they are not made out of size</p>												
												
H 204 L 60	086TK3XS60											
maggiorazione luce surcharge light												
H 204 L 75	086TK3XS75											
maggiorazione luce surcharge light												
H 204 L 90	086TK3XS90											
maggiorazione luce surcharge light												
H 216 L 60	086TK3XU60											
maggiorazione luce surcharge light												
H 216 L 75	086TK3XU75											
maggiorazione luce surcharge light												
H 216 L 90	086TK3XU90											
maggiorazione luce surcharge light												
maggiorazione vetro cannettato per tutte le misure ribbed glass surcharge for all sizes												

# SISTEMA D'ARREDO "TIEKO"

"TIEKO" FURNISHING SYSTEM

GRUPPO LUBE

P 14,2

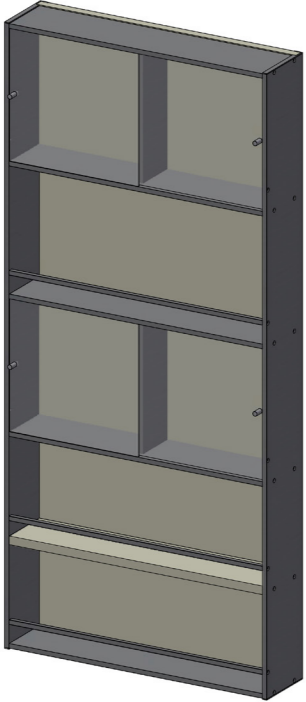
	COD.	MELAMINICI	MATHERIA PET IMMAGINA	WOOD	FENIX	LACCATO UV	LACCATO OPACO	LACCATO SUPER OPACO	LACCATO COME TOP	LAMINATO COME TOP	IMPIALLACCATO	IMPIALLACCATO
											FASCIA A	FASCIA B
<p>colonna H 132/144 P.14,2 sospeso con ripiano legno e 2 vetrine scorrevoli</p> <p><b>N.B.: non si effettuano fuori misura</b> column H 132/144 D.14.2 suspended with wooden shelf and 2 sliding display cases <b>Note: they are not made out of size</b></p> 												
H 132 L 60	086TK3YP60											
maggiorazione luce surcharge light												
H 132 L 75	086TK3YP75											
maggiorazione luce surcharge light												
H 132 L 90	086TK3YP90											
maggiorazione luce surcharge light												
H 144 L 60	086TK3YR60											
maggiorazione luce surcharge light												
H 144 L 75	086TK3YR75											
maggiorazione luce surcharge light												
H 144 L 90	086TK3YR90											
maggiorazione luce surcharge light												
maggiorazione vetro cannettato per tutte le misure ribbed glass surcharge for all sizes												

# SISTEMA D'ARREDO "TIEKO"

"TIEKO" FURNISHING SYSTEM

GRUPPO LUBE

P 14,2

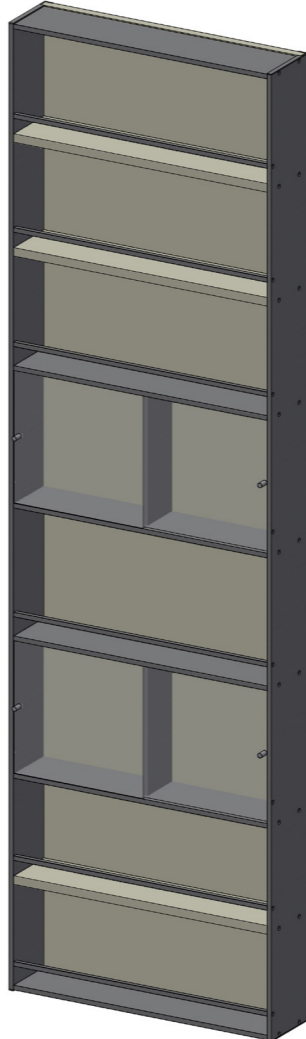
	COD.	MELAMINICI	MATHERIA PET IMMAGINA	WOOD	FENIX	LACCATO UV	LACCATO OPACO	LACCATO SUPER OPACO	LACCATO COME TOP	LAMINATO COME TOP	IMPIALLACCATO	IMPIALLACCATO
											FASCIA A	FASCIA B
<p>colonna H 204/216 P.14,2 sospeso con 3 ripiani legno e 2 vetrine scorrevoli</p> <p><b>N.B.: non si effettuano fuori misura</b> column H 204/216 D.14.2 suspended with 3 wooden shelves and 2 sliding display cases <b>Note: they are not made out of size</b></p> 												
H 204 L 60	086TK3YS60											
maggiorazione luce surcharge light												
H 204 L 75	086TK3YS75											
maggiorazione luce surcharge light												
H 204 L 90	086TK3YS90											
maggiorazione luce surcharge light												
H 216 L 60	086TK3YU60											
maggiorazione luce surcharge light												
H 216 L 75	086TK3YU75											
maggiorazione luce surcharge light												
H 216 L 90	086TK3YU90											
maggiorazione luce surcharge light												
maggiorazione vetro cannettato per tutte le misure ribbed glass surcharge for all sizes												

**RETROTOP "TIEKO" PER BASI H 75 ZOCCOLO H 13 CON GOLA**  
"TIEKO" RETROTOP FOR BASE UNITS H 75 PLINTH H 13 WITH GROOVE

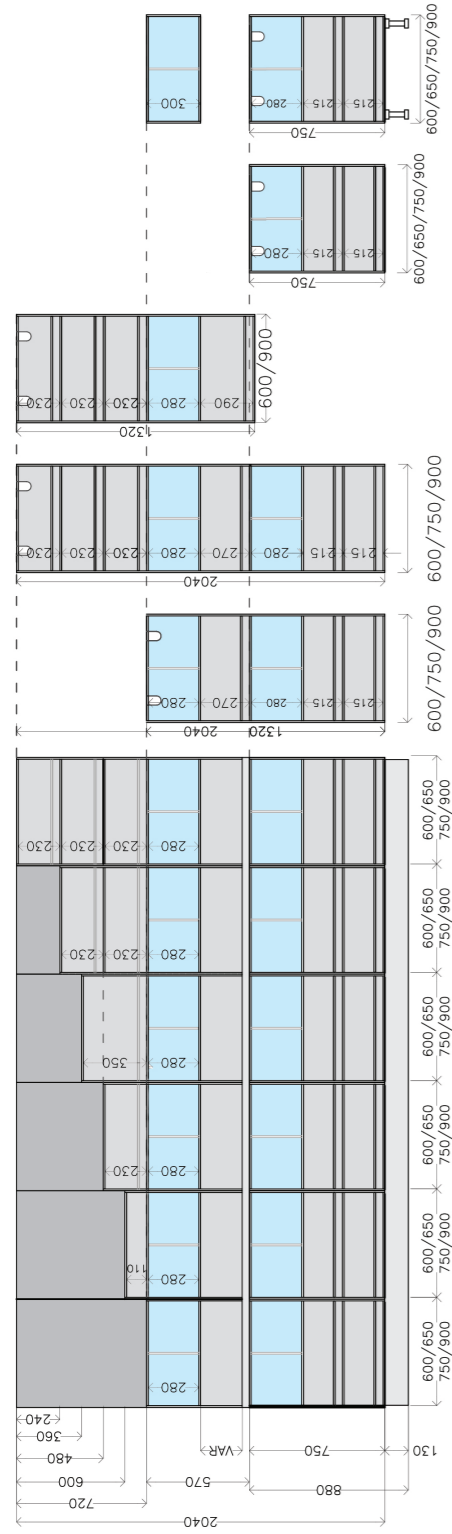

**RETROTOP "TIEKO" PER BASI H 72 ZOCCOLO H 13 SENZA GOLA**  
"TIEKO" RETROTOP FOR BASES H 72 PLINTHS H 13 WITHOUT GROOVE

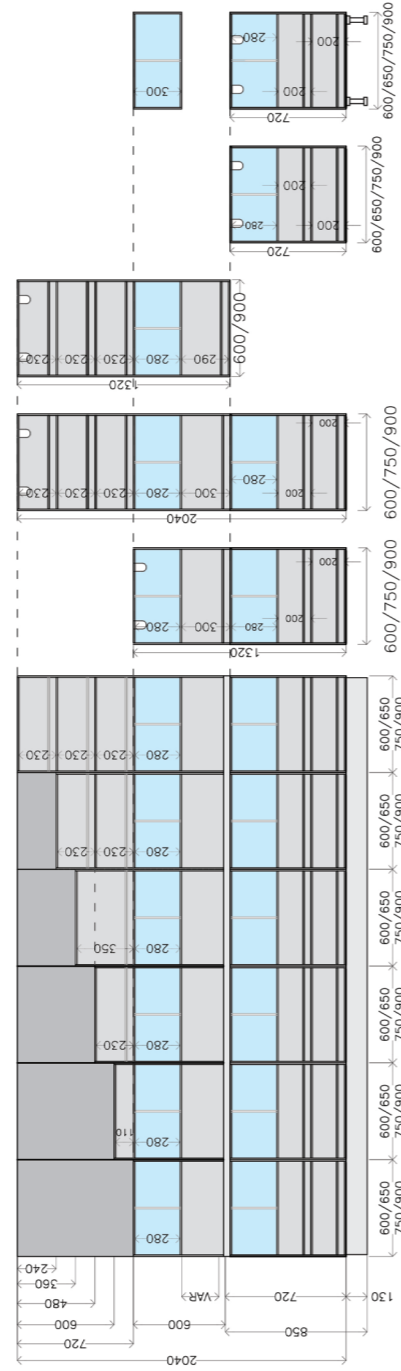

**RETROTOP "TIEKO" PER BASI H 84 ZOCCOLO H 6 CON GOLA**  
"TIEKO" RETROTOP FOR BASE UNITS H84 PLINTH H 6 WITH GROOVE

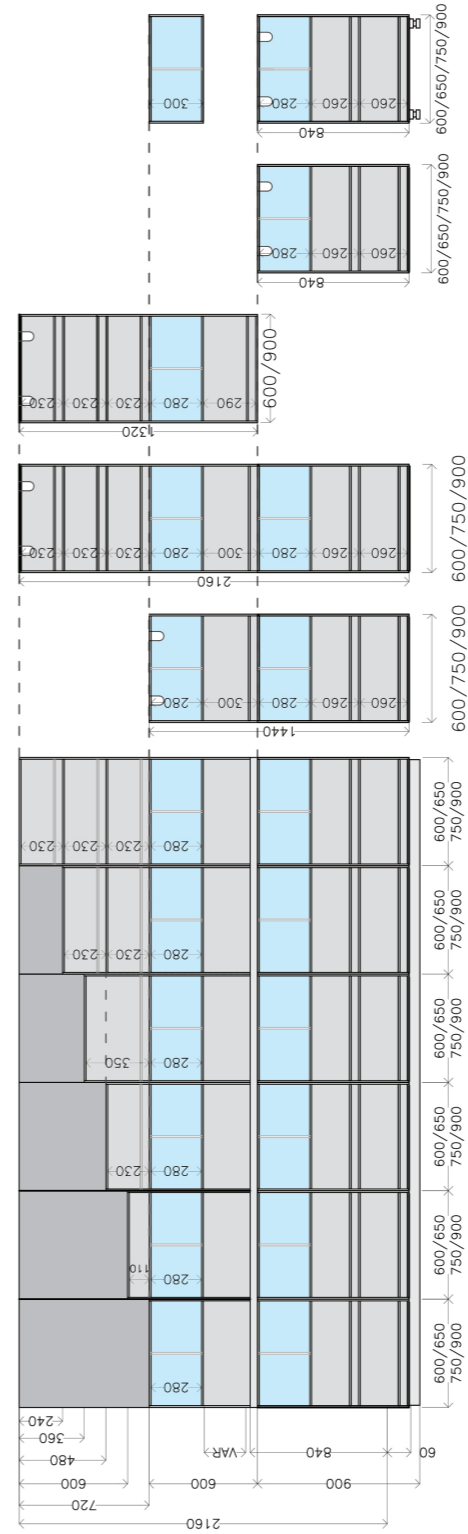

**RETROTOP "TIEKO" PER BASI H 84 ZOCCOLO H 6 SENZA GOLA**  
"TIEKO" RETROTOP FOR BASES H 84 PLINTHS H 6 WITHOUT GROOVE

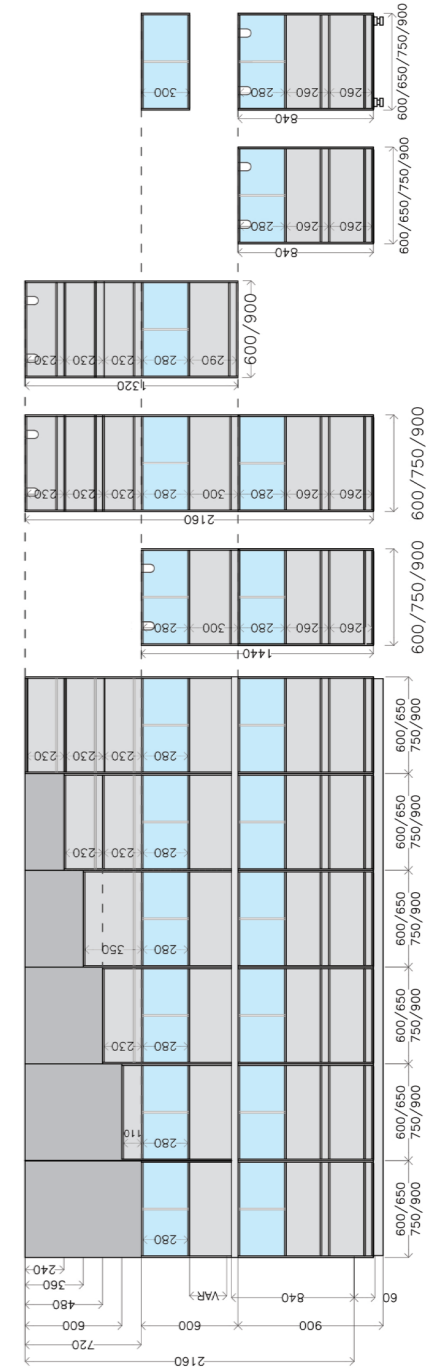

**SOTTOPENSILI H 30 CON SCHIENA NELLE FINITURE INSERITE  
A LISTINO SENZA LUCI**

**UNDER-WALL UNITS H 30 WITH BACK PANEL IN THE FINISHES INCLUDED  
ON THE PRICE LIST WITHOUT LIGHTS**



**SISTEMA D'ARREDO "TIEKO"**

"TIEKO" FURNISHING SYSTEM

GRUPPOLUBE

P 14,2

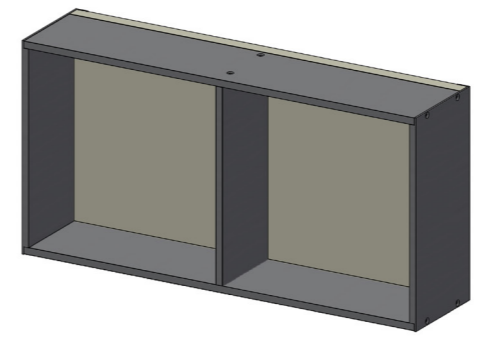

		MELAMINICI	MATHERA PET IMMAGINA	WOOD	FENIX	LACCATO UV	LACCATO OPACO	LACCATO SUPER OPACO	LACCATO COME TOP	LAMINATO COME TOP	IMPIALLACCATO	IMPIALLACCATO
	COD.										FASCIA A	FASCIA B
<p>sottopensile H 30 con schiena</p> <p><b>N.B.: si effettuano fuori misura e disponibile solo senza luce</b></p> <p>under-wll unit H 30 with back</p> <p>Note: they are made out of size and available only without light</p>												
	L 60	086TK9GA60										
	L 65	086TK9GA65										
	L 75	086TK9GA75										
	L 90	086TK9GA90										





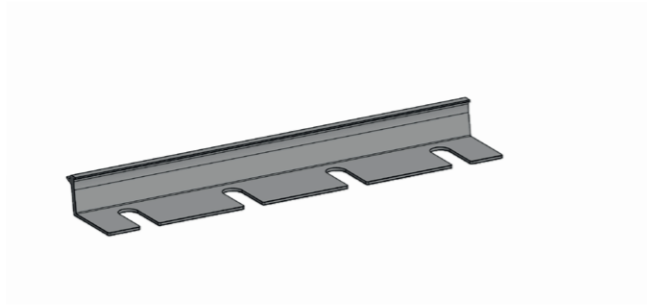

		COD.
<p><b>Porta rotoli per ripiano alluminio</b> Roll holder for aluminum shelf</p> 		
	<p><b>nero verniciato</b> painted black</p> <p><b>titanio verniciato</b> painted titanium</p> <p><b>umber verniciato</b> painted umber</p> <p><b>rame brunito verniciato</b> painted burnished copper</p> <p><b>ottone verniciato</b> painted titanium</p>	<p>086TKA05NV</p> <p>086TKA05TV</p> <p>086TKA05UV</p> <p>086TKA05RBV</p> <p>086TKA05OV</p>
<p><b>Porta calici per ripiano alluminio</b> Stem rack for aluminum shelf</p> 		
	<p><b>nero verniciato</b> painted black</p> <p><b>titanio verniciato</b> painted titanium</p> <p><b>umber verniciato</b> painted umber</p> <p><b>rame brunito verniciato</b> painted burnished copper</p> <p><b>ottone verniciato</b> painted titanium</p>	<p>086TKA03NV</p> <p>086TKA03TV</p> <p>086TKA03UV</p> <p>086TKA03RBV</p> <p>086TKA03OV</p>

		COD.
<p><b>Set 3 ganci per ripiano alluminio</b> Set 3 hooks for aluminum shelf</p> 		
	<p><b>Set 3 ganci</b></p>	<p>086TKA01</p>
<p><b>Pannello retro piano cottura e lavello</b> <b>N.B.: non inseribili con elementi senza schiena</b> Hob and sink back panel <b>Note: not insertable with elements without backrest</b></p>  		
	<p><b>Set 3 ganci</b> Set 3 hooks</p> <p><b>N.B.: obbligatorio in presenza di piano cottura</b> <b>Note: mandatory in the presence of a hob</b></p>	<p>L 64 086TKA20</p> <p>L 69 086TKA21</p> <p>L 79 086TKA22</p> <p>L 94 086TKA23</p> <p>L 124 086TKA25</p> <p><b>Set 3 ganci</b> 086TKA02</p>

## KIT BASE

### Alimentazione basilare/Connessione diretta Basic power supply/Direct connection

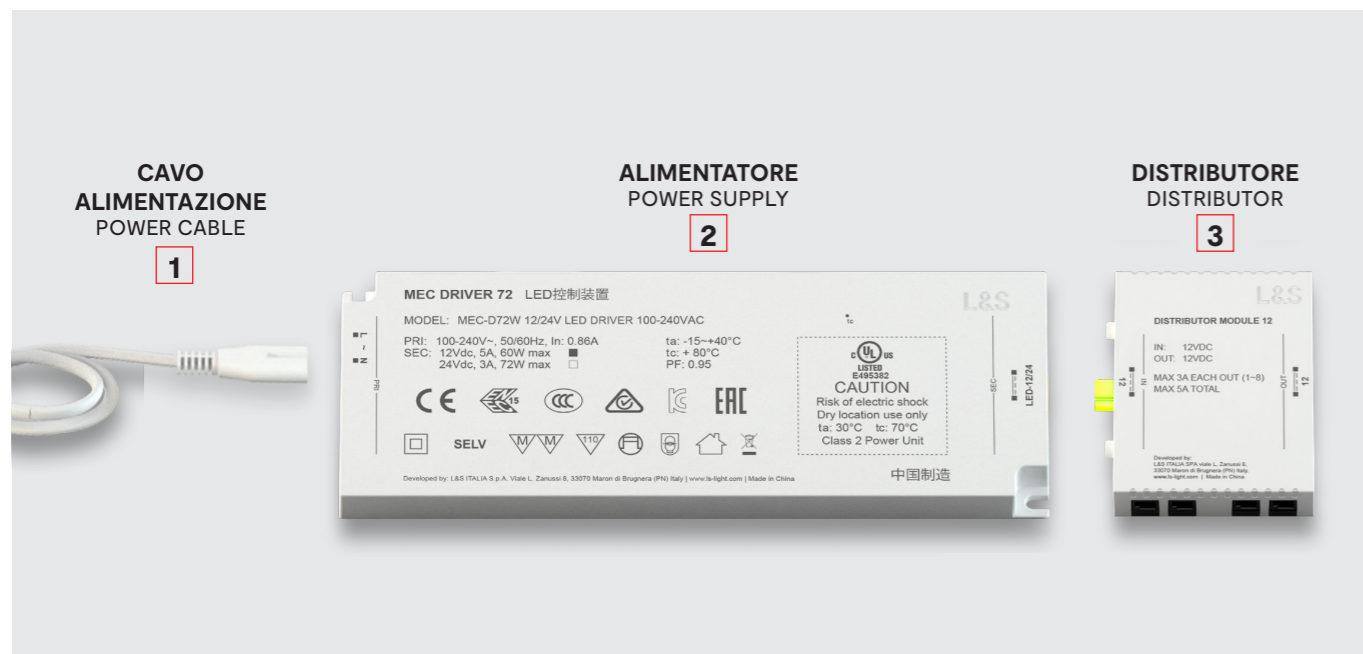

#### Composto da:

- 1) CAVO ALIMENTAZIONE (EU/USA/Canada)
- 2) ALIMENTATORE **in base alla potenza necessaria**
- 3) DISTRIBUTORE

#### Composed of:

- 1) POWER CABLE (EU/USA/Canada)
- 2) POWER SUPPLY **according to the power request**
- 3) DISTRIBUTOR

#### KIT ALIMENTAZIONE EUROPA EUROPE POWER SUPPLY KIT

KIT EUROPA	POWER	OUTPUT	codice code
12422150000	18 W	24 V DC	08618000EU
12422160000	36 W	24 V DC	08618001EU
12422170000	48 W	24 V DC	08618002EU
12422180000	72 W	24 V DC	08618003EU
12422190000	90 W	24 V DC	08618004EU
12425890000	120 W	24 V DC	08618005EU

#### KIT ALIMENTAZIONE USA/CANADA USA/CANADA POWER SUPPLY KIT

KIT USA/CANADA	POWER	OUTPUT	codice code
12422070000	18 W	24 V DC	08618000UL
12422080000	36 W	24 V DC	08618001UL
12422080000	48 W	24 V DC	08618002UL
12422100000	60 W	24 V DC	08618003UL
12422580000	90 W	24 V DC	08618004UL

### Accensione con telecomando (1 zona) Switch on with remote control (1 area)

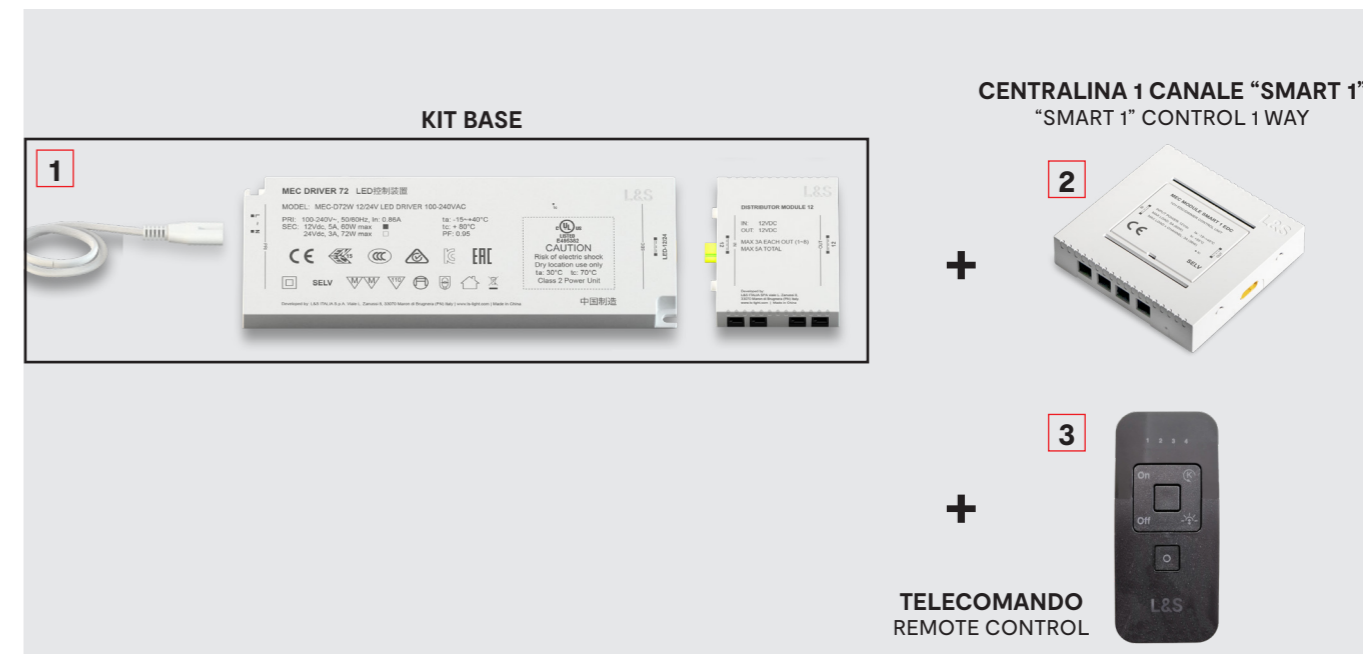

#### Composto da:

- 1) KIT BASE (EUROPA o USA/Canada)
- 2) CENTRALINA 1 CANALE "SMART 1"
- 3) TELECOMANDO

#### Composed of:

- 1) BASIC KIT (EUROPE or USA/Canada)
- 2) "SMART 1" CONTROL 1 WAY
- 3) REMOTE CONTROL

#### 2) CENTRALINA 1 CANALE "SMART 1" "SMART 1" CONTROL 1 WAY



OUTPUT: Max 5 A total, max 3 A/output

SMART 1	TIPO	INPUT	WAYS	codice code
24201880100	EDC	24 V DC	8	08618031

La centralina *Smart 1* consente di controllare simultaneamente fino a 8 lampade in uscita con i telecomandi della linea *Smart Up 1* e *Smart Up 4*. I moduli possono essere connessi ad altri moduli di distribuzione o di controllo purché si mantenga la stessa tensione in uscita.

The *Smart 1* control unit allows you to simultaneously control up to 8 output lamps with the *Smart Up 1* and *Smart Up 4* remote controls. The modules can be connected to other distribution or control modules as long as the same output voltage is maintained.

#### 3) TELECOMANDO 4 CANALI REMOTE CONTROL 4 WAYS



#### SMART UP 4

- ✓ On/Off - Dimmerazione - Gestione del colore
- ✓ 15 m portata all'interno di edifici
- ✓ Batteria CR2032 (3 anni di durata)
- ✓ On/Off - Dimming - Colour management
- ✓ 15 m range indoor
- ✓ Battery CR2032 (3 years lasting)

SMART UP 4 (4 CANALI)	TIPO	DIMENSIONI	codice code
24203250300	EDC	82x37x10	08618035

## Accensione con app "BlueSmart" o telecomando (4 zone)

Switch on with "BlueSmart" app or remote control (4 areas)

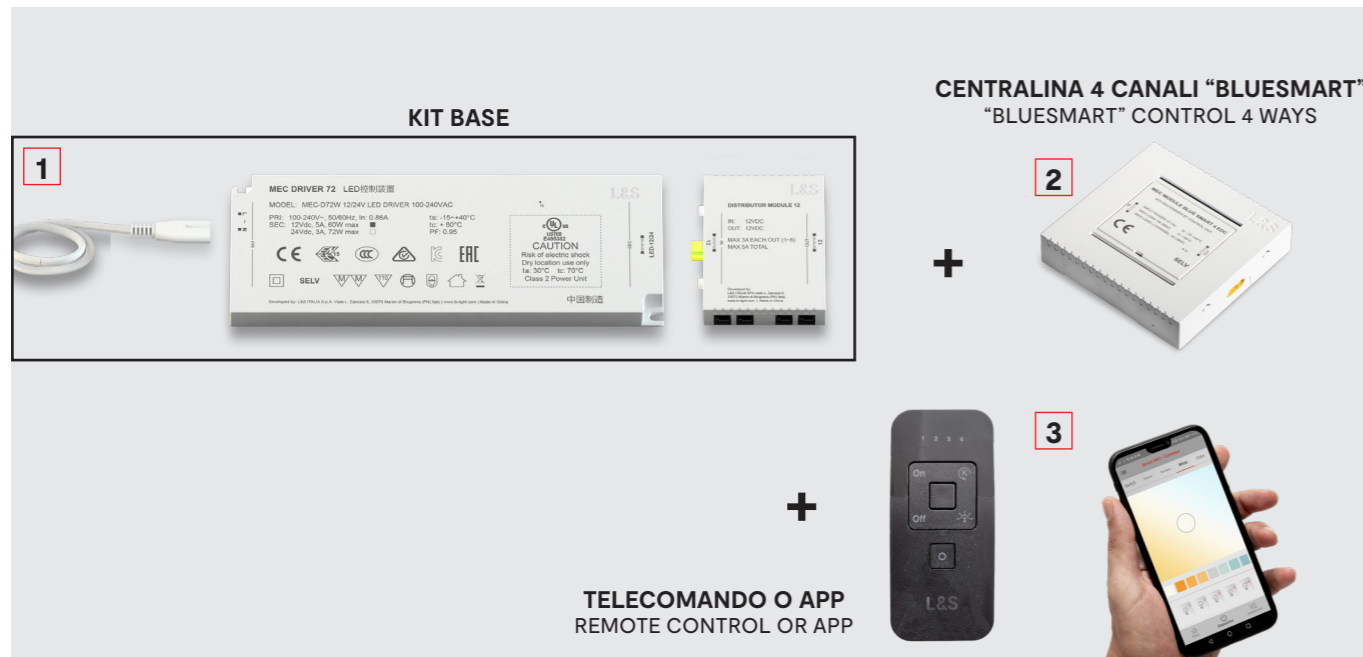

### Composto da:

- 1) KIT BASE (EUROPA o USA/Canada)
- 2) CENTRALINA 4 CANALI "BLUESMART 4" (Bluetooth)
- 3) TELECOMANDO 4 CANALI "SMART UP 4" o App "BlueSmart"

### Composed of:

- 1) BASIC KIT (EUROPE or USA/Canada)
- 2) "BLUESMART" CONTROL 4 WAYS (Bluetooth)
- 3) REMOTE CONTROL 4 WAYS "SMART UP 4" or "BlueSmart" App

## 2 CENTRALINA 4 CANALI "BLUESMART" "BLUESMART" CONTROL 4 WAYS



OUTPUT: Max 5 A total, max 3 A/output

BLUESMART	TIPO	INPUT	WAYS	codice code
24201770100	EDC	24 V DC	4	08618030

La centralina BlueSmart consente di controllare individualmente fino a 4 lampade in uscita tramite l'apposita app, scaricabile gratuitamente da App Store e Google Play. È inoltre compatibile con i telecomandi della linea Smart Up 1 e Smart Up 4. I moduli possono essere connessi ad altri moduli di distribuzione o di controllo purché si mantenga la stessa tensione in uscita.

The BlueSmart control unit allows you to individually control up to 4 output lamps using the Bluesmart app, which can be downloaded for free from the App Store and Google Play. It is also compatible with the Smart Up 1 and Smart Up 4 remote controls. The modules can be connected to other distribution or control modules as long as the same output voltage is maintained.

## 3 TELECOMANDO 4 CANALI REMOTE CONTROL 4 WAYS



### SMART UP 4

- On/Off - Dimmerazione - Gestione del colore
- 15 m portata all'interno di edifici
- Batteria CR2032 (3 anni di durata)
- On/Off - Dimming - Colour management
- 15 m range indoor
- Battery CR2032 (3 years lasting)

SMART UP 4 (4 CANALI)	TIPO	DIMENSIONI	codice code
24203250300	EDC	82x37x10	08618035

## APP "BLUESMART" "BLUESMART" APP

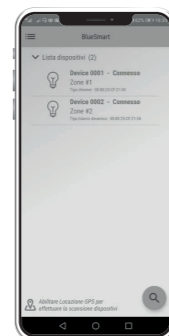

Vedi spiegazioni a pagina 38.  
See explanations on page 38.



## MOLTIPLICATORE INGRESSI INPUT MULTIPLIER



INPUT: 24 V DC

MOLTIPLICATORE	WAYS	CAVO	codice code
12606760000	10	200 mm	08618026

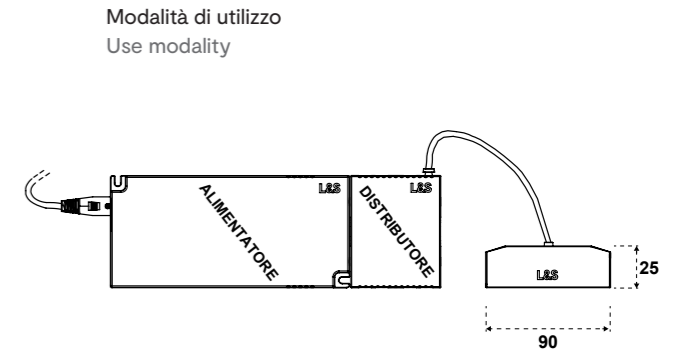

Il moltiplicatore di ingressi consente di collegare fino a 10 lampade per ogni ingresso del modulo. Può essere inserito su tutti i KIT.

The input multiplier allows up to 10 lamps to be connected to each input of the module. It can be inserted on all KIT.

## PROLUNGA EXTENSION



INPUT: 24 V DC

PROLUNGA	CAVO	codice code
	2000 mm	08618029

Prolunga universale per tutti i prodotti. Da utilizzare in aggiunta ai cavi standard per distanze maggiori tra alimentatore e elemento luminoso.

Universal extension cable for all products. To be used in addition to standard cables for longer distances between ballast and lighting element.

**SCHEMA MONTAGGIO LUCI**  
**LIGHTS ASSEMBLY DIAGRAM**

In fase di montaggio si può scegliere se far uscire i cavi sul lato inferiore o superiore, tramite l'utilizzo della scanalatura sul retro dello schienale.

*During assembly, you can choose whether to run the cables out the bottom or the top side, through the use of the groove on the back of the backrest.*

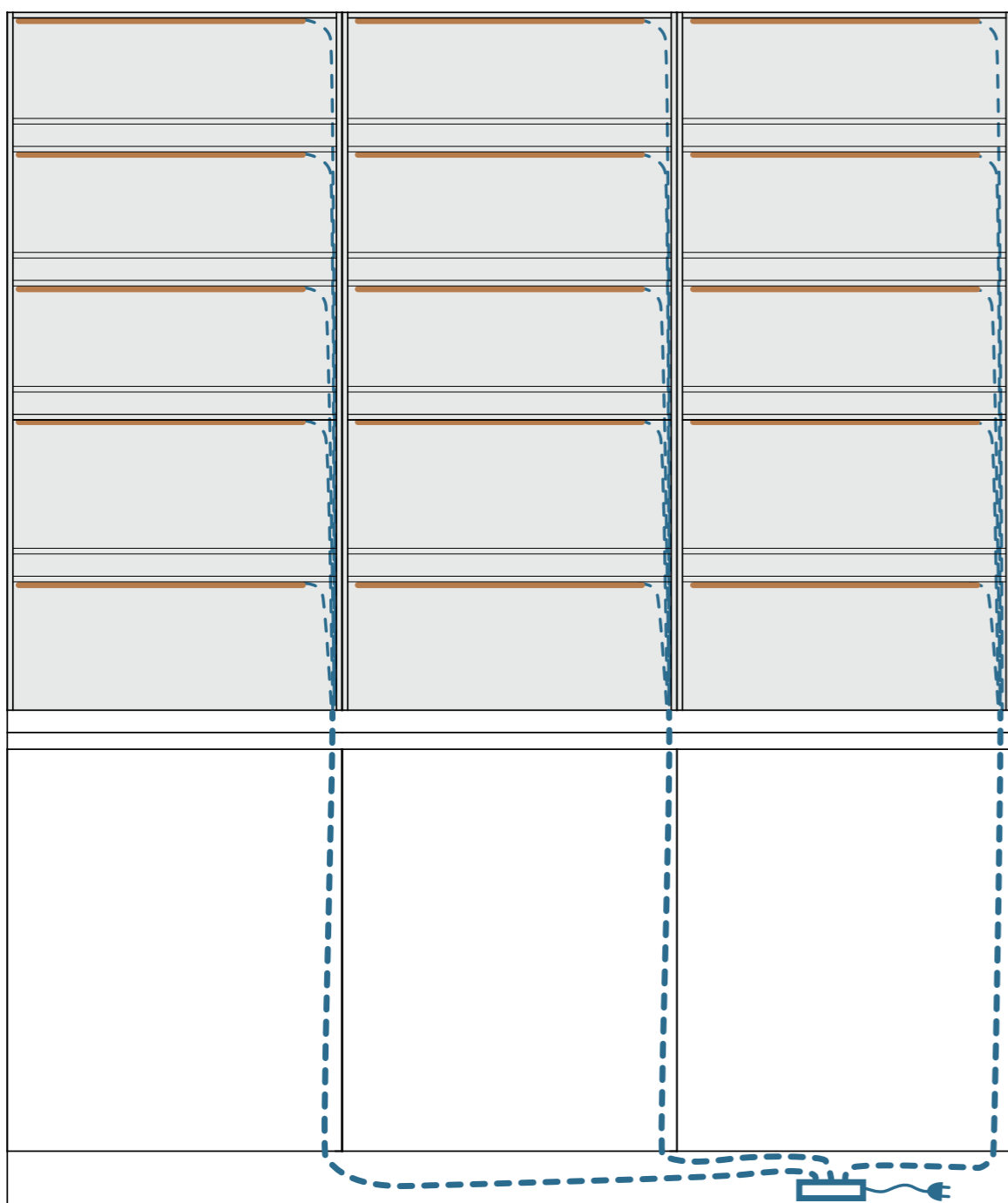

versione uscita cavi inferiore.  
*lower cable outlet version.*

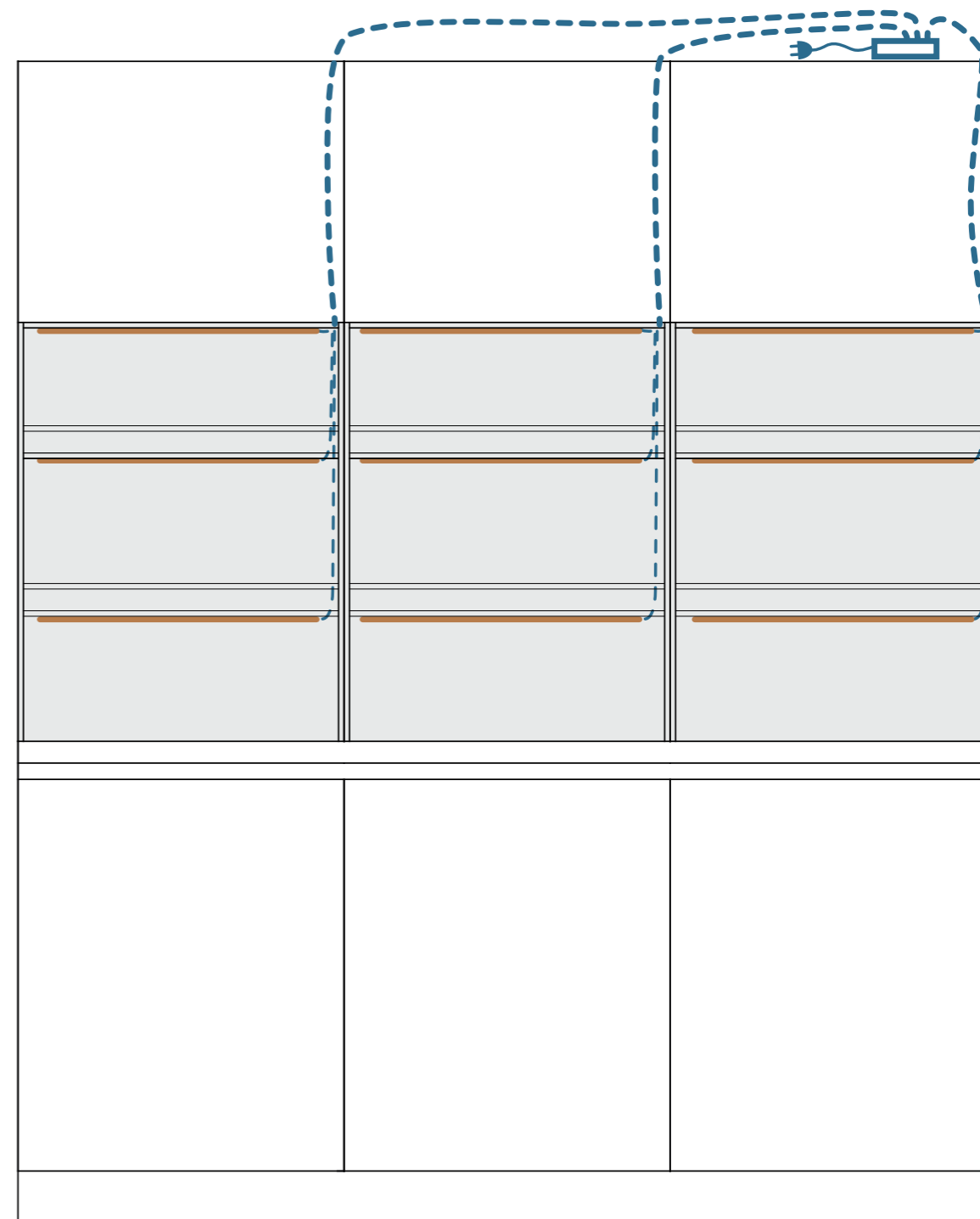

versione uscita cavi superiore.  
*upper cable outlet version.*