

GRUPPOLUBE



MULTIPLO

2021



“MULTIPLO”
“MULTIPLO”



SISTEMA MODULARE “MULTIPLO”

MODULAR SYSTEM “MULTIPLO”

“MULTIPLO” è un sistema multifunzionale con struttura in alluminio, che permette la realizzazione di strutture a giorno. La versatilità del sistema e la sua semplicità consistono nella facilità di montaggio e nell’essenzialità dell’estetica, rendendolo perfetto per ogni ambiente.

“MULTIPLO” is a multifunctional system with aluminium structure, that allow to create opened structure solutions. The versatility and the simplicity of this project lay in the essential look and its easy to assemble nature, making it perfect for every space.



ESEMPIO DI VERSIONE LIBRERIA A PARETE CON KIT LUCE LED DUAL COLOR
EXAMPLE OF THE WALL BOOKCASE VERSION WITH DUAL COLOR LED LIGHT KIT

SISTEMA MODULARE "MULTIPLO"

MODULAR SYSTEM "MULTIPLO"

Disponibile in 4 VERSIONI DIFFERENTI

Available in 4 DIFFERENT VERSIONS

SOTTOPENSILE

UNDER WALL UNIT



SOSPESO

HANGING



LIBRERIA A PARETE

WALL BOOKCASE



TERMINALE

END UNIT



FINITURE DISPONIBILI PER STRUTTURA

AVAILABLE STRUCTURE FINISHES



nero (opz.7892)
black (opt.7892)



silver dark (opz.9507)
dark silver (opt.9507)



grigio selce (opz.SEL)
flint grey (opt.SEL)

**N.B.: PER IL MONTAGGIO CONSULTARE
L'APPOSITO LIBRETTO DI ISTRUZIONI**
NOTE: SEE INSTRUCTION MANUAL FOR ASSEMBLY

“MULTIPLO” SOTTOPENSILE

“MULTIPLO” UNDER WALL UNIT

Struttura modulare in alluminio con piastre per fissaggio a parete e installazione tra pensile e base. Completa di supporti e traversi orizzontali per aggancio di mensole disponibili in versione melaminico, laccato opaco e metallo.

Possibilità di inserire il kit luce led Dual Color con telecomando nella parte posteriore dei montanti.

Disponibile nelle larghezze L 60-90 cm e nell'altezza H 36 cm. Portata massima 20 kg (per ogni mensola).

Modular aluminium wall-mounted structure with plates for the placement between wall unit and base unit.

Included supports and horizontal beams for melamine, matt lacquered and metal shelves.

Possibility to insert Dual Color led light kit with remote control in the rear of pillars.

Available in widths W 60-90 cm and in height H 36 cm. Load capacity 20 kg (for each shelf).

VISTA FRONTALE
FRONT VIEW

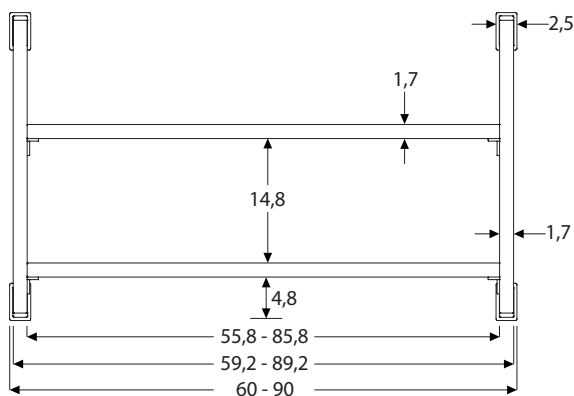

VISTA LATERALE
SIDE VIEW

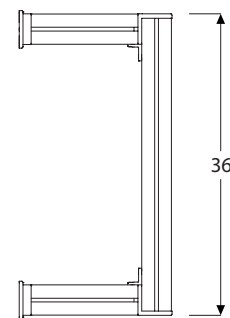

VISTA SUPERIORE
TOP VIEW

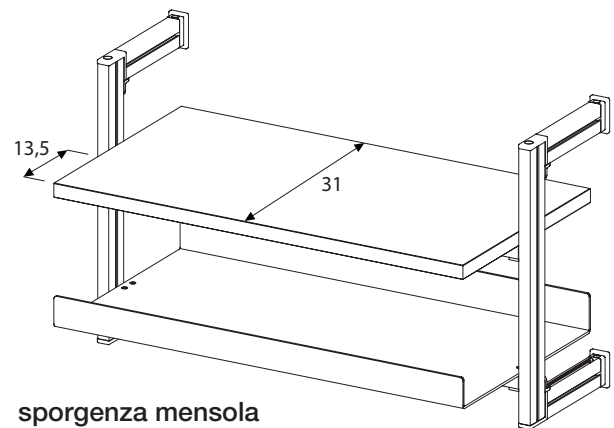
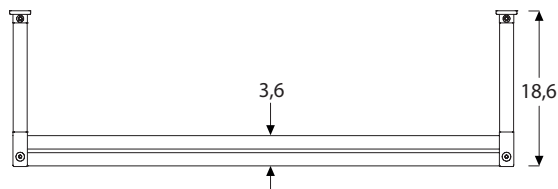

Disponibili mensole in melaminico/laccato opaco e in metallo di L 55,8 e L 85,8 P 31 cm (vedi pag.12). Per schema montanti con kit luce led Dual Color e alimentatori (vedi pag.13).

Available melamine/matt lacquered and metal shelves W 55,8 and W 85,8 D 31 cm (see page 12).

Diagram pillars with Dual Color led light kit and power supplies (see page 13).

“MULTIPLO” SOTTOPENSILE

“MULTIPLO” UNDER WALL UNIT

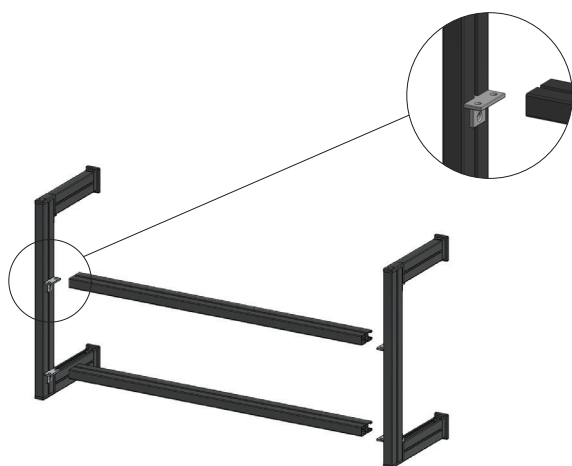

Struttura singola composta da:

- montante sx con supporti e traversi orizzontali nr.2 per H 36

- montante dx con supporti (per fine composizione)

Single structure consist of:

- LH pillar with supports and horizontal beams nr.2 for H 36

- RH pillar with supports (for end composition)

H 36 L 60 08902401

H 36 L 90 08902403

Magg. kit luce led Dual Color (per 2 montanti)

Surcharge led light kit Dual Color (for 2 pillars) H

36 opz.002

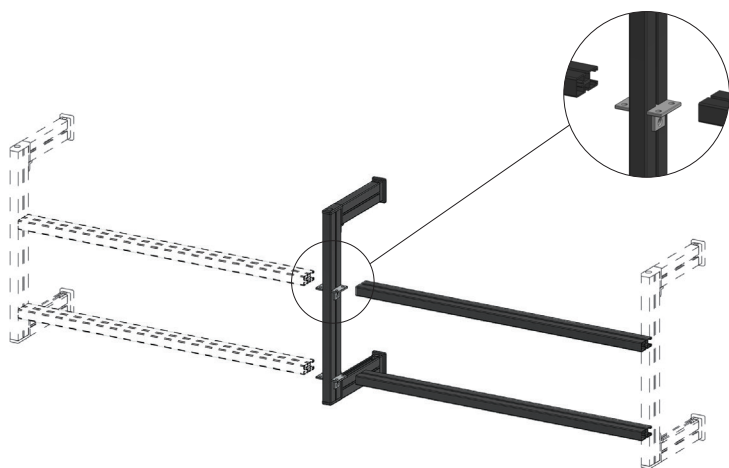

Struttura centrale composta da:

- montante centrale con supporti e traversi orizzontali nr.2 per H 36

Central structure consist of:

- central pillar with supports and horizontal beams nr.2 for H 36

H 36 L 57,9 08902401C

H 36 L 87,9 08902403C

Magg. kit luce led Dual Color (per 1 montante)

Surcharge led light kit Dual Color (for 1 pillar)

H 36 opz.002

Per esempi di modularità vedi pag. 18-20.

N.B.: nella realizzazione di composizioni con struttura singola e centrale il montante dx deve essere sempre spostato a fine composizione.

(ACCESSORIO PORTABOTTIGLIE NON DISPONIBILE)

For modularity examples see page 18-20.

Note: RH pillar must always be moved at the end of the composition when there are single and central structures (BOTTLES RACK ACCESSORY NOT AVAILABLE)

“MULTIPLO” SOSPESO

“MULTIPLO” HANGING

Struttura modulare in alluminio con piastre per fissaggio a parete. Completa di supporti e traversi orizzontali per aggancio di mensole disponibili in versione melaminico, laccato opaco e metallo. Possibilità di inserire il kit luce led Dual Color con telecomando nella parte posteriore dei montanti. Disponibile nelle larghezze L 60-90 cm e nelle altezze H 108-180 cm.

Portata massima 20 kg (per ogni mensola).

Modular aluminium wall-mounted structure with plates. Included supports and horizontal beams for melamine, matt lacquered and metal shelves. Possibility to insert Dual Color led light kit with remote control in the rear of pillars. Available in widths W 60-90 cm and in heights H 108-180 cm. Load capacity 20 kg (for each shelf).

VISTA FRONTALE
FRONT VIEW

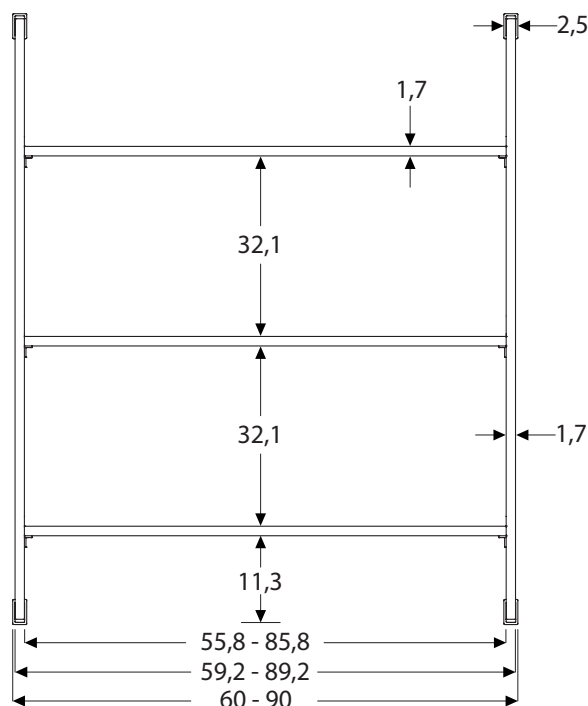

VISTA LATERALE
SIDE VIEW

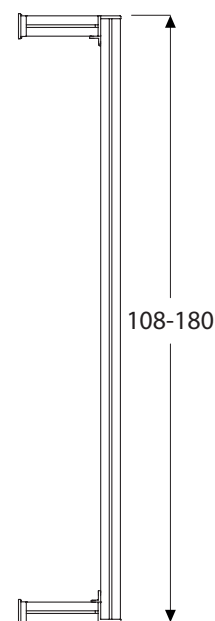

VISTA SUPERIORE
TOP VIEW

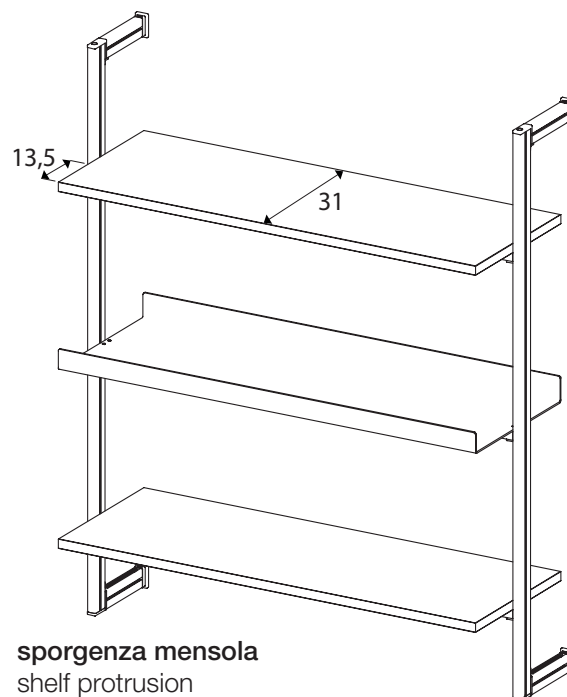
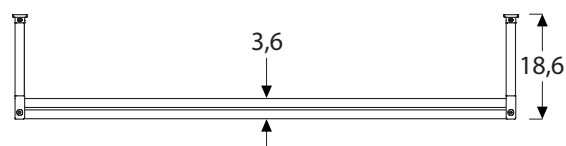

Disponibili mensole in melaminico/laccato opaco e in metallo di L 55,8 e L 85,8 P 31 cm (vedi pag.12). Per schema montanti con kit luce led Dual Color e alimentatori (vedi pag.13).

Available melamine/matt lacquered and metal shelves W 55,8 and W 85,8 D 31 cm (see page 12).

Diagram pillars with Dual Color led light kit and power supplies (see page 13).

“MULTIPLO” SOSPESO

“MULTIPLO” HANGING

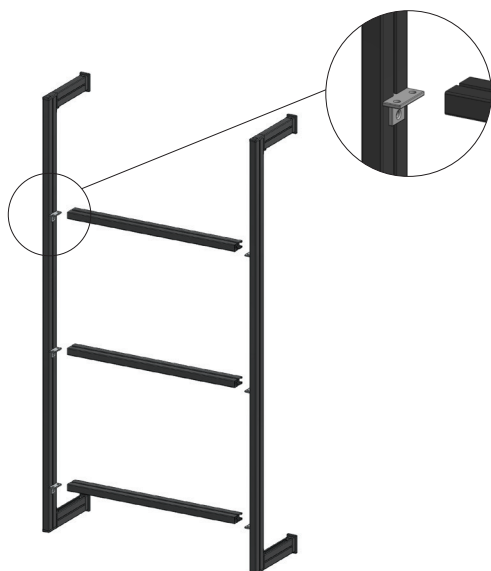

Struttura singola composta da:

- montante sx con supporti e traversi orizzontali
nr.3 per H 108
nr.5 per H 180

- montante dx con supporti (per fine composizione)

Single structure consist of:

- LH pillar with supports and horizontal beams
nr.3 for H 108
nr.5 for H 180
- RH pillar with supports (for end composition)

H 108 L 60 08902405

H 108 L 90 08902407

H 180 L 60 08902411

H 180 L 90 08902413

Magg. kit luce led Dual Color (per 2 montanti)

Surcharge led light kit Dual Color (for 2 pillars)

H 108 opz.002

H 180 opz.002

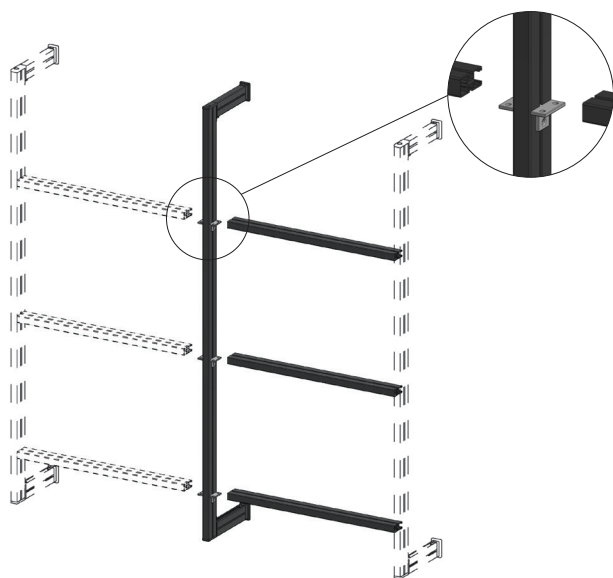

Struttura centrale composta da:

- montante centrale con supporti e traversi orizzontali
nr.3 per H 108
nr.5 per H 180

Central structure consist of:

- central pillar with supports and horizontal beams
nr.3 for H 108
nr.5 for H 180

H 108 L 57,9 08902405C

H 108 L 87,9 08902407C

H 180 L 57,9 08902411C

H 180 L 87,9 08902413C

Magg. kit luce led Dual Color (per 1 montante)

Surcharge led light kit Dual Color (for 1 pillar)

H 108 opz.002

H 180 opz.002

Per esempi di modularità vedi pag. 18-20.

N.B.: nella realizzazione di composizioni con struttura singola e centrale il montante dx deve essere sempre spostato a fine composizione.

For modularity examples see page 18-20.

Note: RH pillar must always be moved at the end of the composition when there are single and central structures

“MULTIPLO” LIBRERIA A PARETE

“MULTIPLO” WALL BOOKCASE

Struttura modulare in alluminio con appoggio a terra e piastre per fissaggio a parete. Completa di supporti e traversi orizzontali per aggancio di mensole disponibili in versione melaminico, laccato opaco e metallo. Possibilità di inserire il kit luce led Dual Color con telecomando nella parte posteriore dei montanti.

Disponibile nelle larghezze L 60-90 cm e nelle altezze H 217-222 cm. Portata massima 20 kg (per ogni mensola).

Modular ground aluminium structure with plates for fixing to wall. Included supports and horizontal beams melamine, matt lacquered and metal shelves. Possibility to insert Dual Color led light kit with remote control in the rear of pillars. Available in widths W 60-90 cm and in heights H 217-222 cm. Load capacity 20 kg (for each shelf).

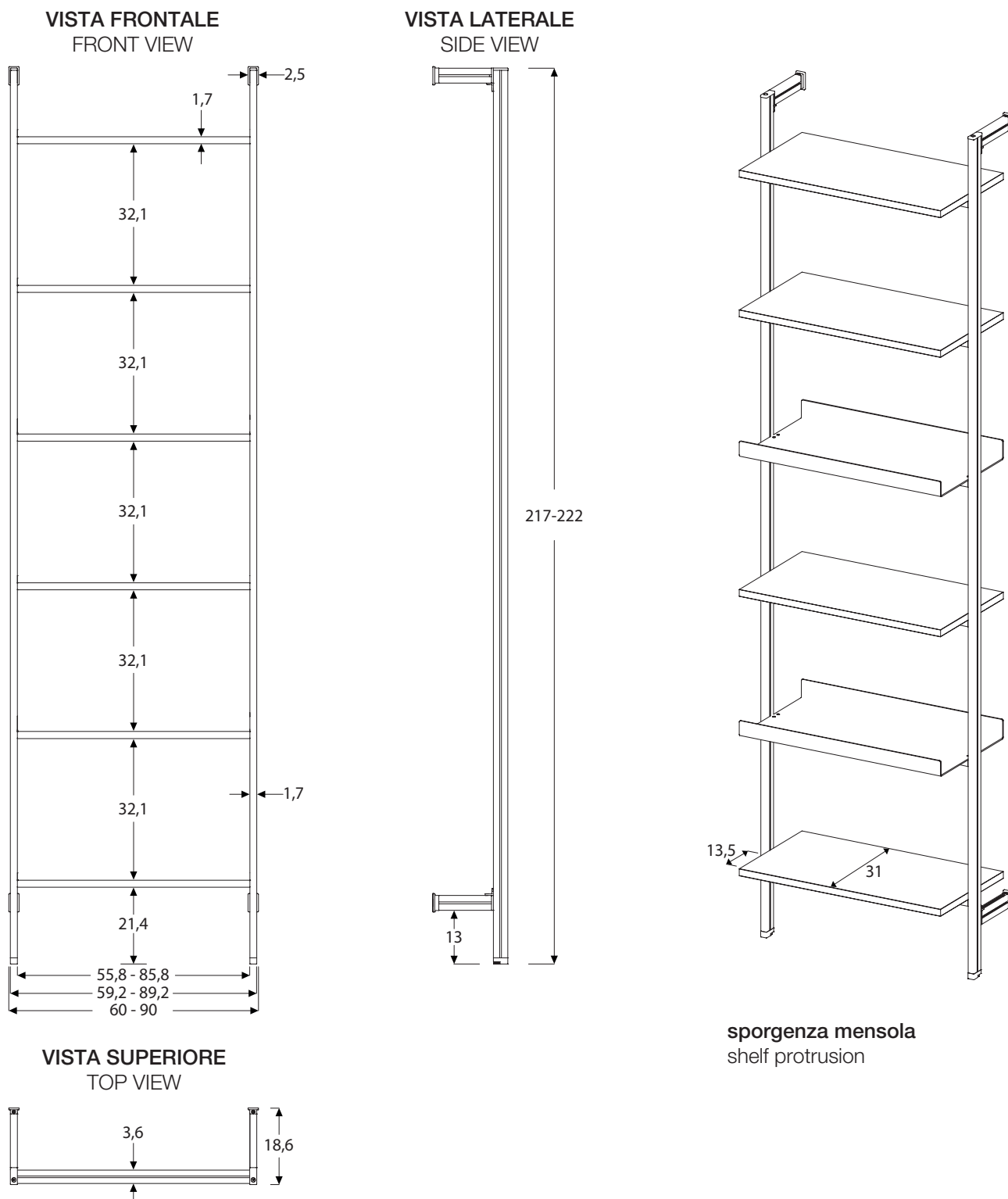

Disponibili mensole in melaminico/laccato opaco e in metallo di L 55,8 e L 85,8 P 31 cm (vedi pag.12). Per schema montanti con kit luce led Dual Color e alimentatori (vedi pag.13).

Available melamine/matt lacquered and metal shelves W 55,8 and W 85,8 D 31 cm (see page 12). Diagram pillars with Dual Color led light kit and power supplies (see page 13).

Available melamine/matt lacquered and metal shelves W 55,8 and W 85,8 D 31 cm (see page 12). Diagram pillars with Dual Color led light kit and power supplies (see page 13).

“MULTIPLO” LIBRERIA A PARETE

“MULTIPLO” WALL BOOKCASE

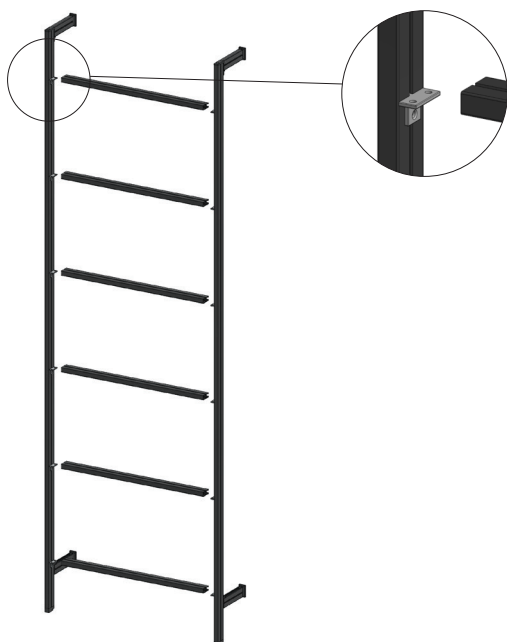

Struttura singola composta da:

- montante sx con supporti e traversi orizzontali
nr.6 per H 217
nr.6 per H 222

- montante dx con supporti (per fine composizione)

Single structure consist of:

- LH pillar with supports and horizontal beams
nr.6 for H 217
nr.6 for H 222
- RH pillar with supports (for end composition)

H 217 L 60 08902421

H 217 L 90 08902423

H 222 L 60 08902425

H 222 L 90 08902427

Magg. kit luce led Dual Color (per 2 montanti)

Surcharge led light kit Dual Color (for 2 pillars)

H 217 opz.002

H 222 opz.002

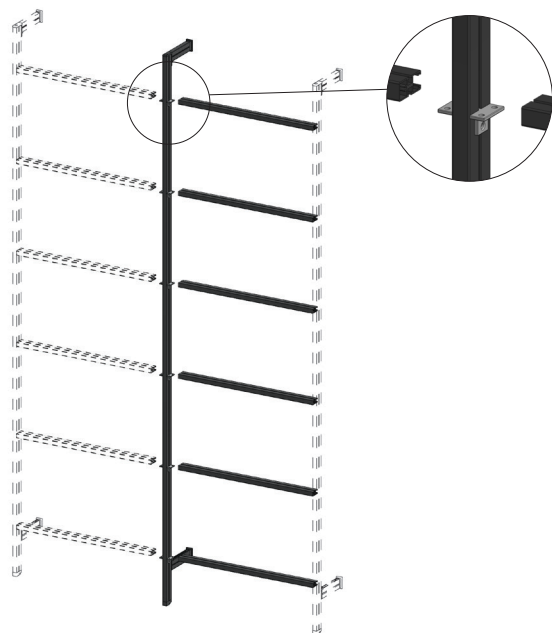

Struttura centrale composta da:

- montante centrale con supporti e traversi orizzontali
nr.6 per H 217
nr.6 per H 222

Central structure consist of:

- central pillar with supports and horizontal beams
nr.6 for H 217
nr.6 for H 222

H 217 L 57,9 08902421C

H 217 L 87,9 08902423C

H 222 L 57,9 08902425C

H 222 L 87,9 08902427C

Magg. kit luce led Dual Color (per 1 montante)

Surcharge led light kit Dual Color (for 1 pillar)

H 217 opz.002

H 222 opz.002

Per esempi di modularità vedi pag. 18-20.

N.B.: nella realizzazione di composizioni con struttura singola e centrale il montante dx deve essere sempre spostato a fine composizione.

For modularity examples see page 18-20.

Note: RH pillar must always be moved at the end of the composition when there are single and central structures

“MULTIPLO” TERMINALE

“MULTIPLO” END UNIT

Struttura singola in alluminio con piastre per fissaggio su fianco base/colonna e installazione a fine composizione. Completa di supporti e traversi orizzontali per aggancio di mensole disponibili in versione melaminico, laccato opaco e metallo. Disponibile nella larghezza L 45 cm e nelle altezze H 60-108-180 cm.

Portata massima 20 kg (per ogni mensola). **NON MODULABILE.**

Single aluminium structure mounted on side of the base unit/column at the end of the composition.

Included supports and horizontal beams for melamine, matt lacquered and metal shelves.

Available in width W 45 cm and in heights H 60-108-180 cm. Load capacity 20 kg (for each shelf). **NOT ADJUSTABLE.**

VISTA FRONTALE
FRONT VIEW

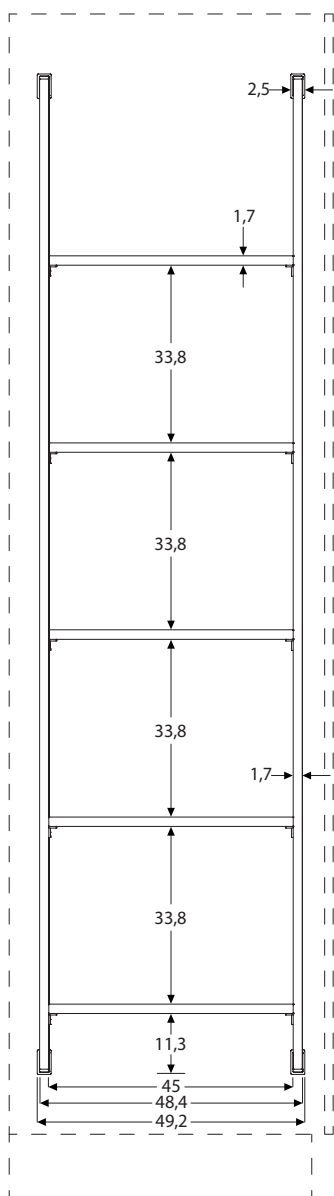

VISTA LATERALE
SIDE VIEW

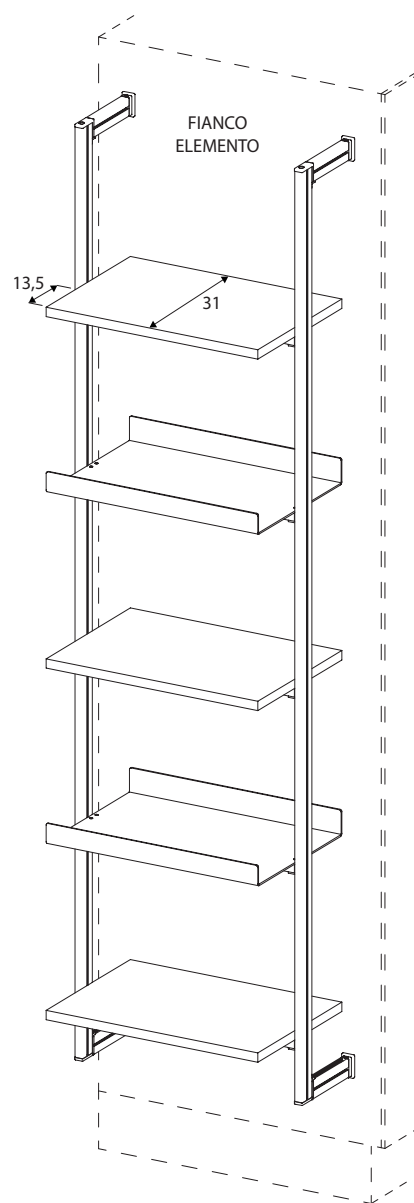
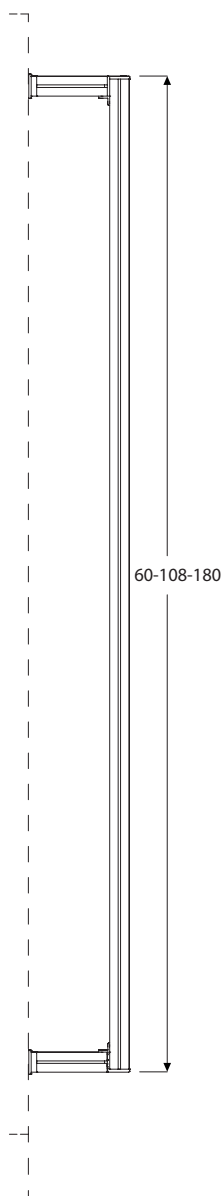

sporgenza mensola
shelf protrusion

VISTA SUPERIORE
TOP VIEW

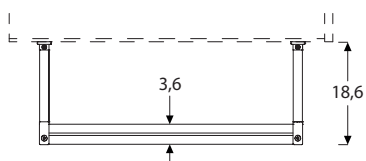

Disponibili mensole in melaminico/laccato opaco e in metallo di L 45 P 31 cm (vedi pag.12).

N.B.: KIT LUCE LED E ACCESSORIO PORTABOTTIGLIE NON DISPONIBILE

Available melamine/matt lacquered and metal shelves W 41 D 31 cm (see page 12).

Note: LED LIGHT KIT AND BOTTLES RACK ACCESSORY NOT AVAILABLE

“MULTIPLO” TERMINALE

“MULTIPLO” END UNIT

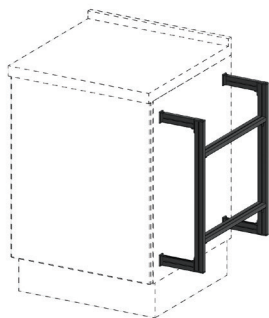

Struttura singola H 60 L 45 composta da:

- montante sx con supporti
- 2 traversi orizzontali
- montante dx con supporti

Single structure H 60 W 45 consist of:

- LH pillar with supports
- 2 horizontal beams
- RH pillar with supports

H 60 L 45 08902260

Per basi H 72/75/84
For base units H 72/75/84

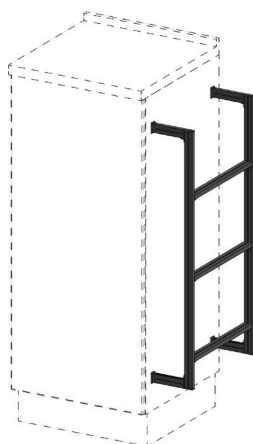

Struttura singola H 108 L 45 composta da:

- montante sx con supporti
- 3 traversi orizzontali
- montante dx con supporti

Single structure H 108 W 45 consist of:

- LH pillar with supports
- 3 horizontal beams
- RH pillar with supports

H 108 L 45 08902263

Per colonne H 132/144
For columns H 132/144

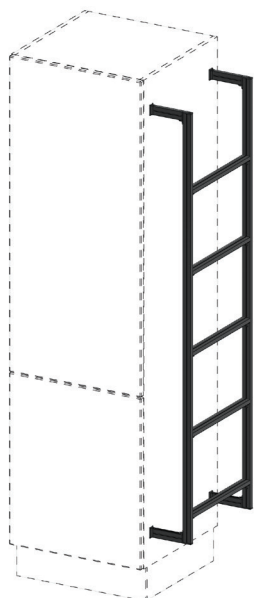

Struttura singola H 180 L 45 composta da:

- montante sx con supporti
- 5 traversi orizzontali
- montante dx con supporti

Single structure H 180 W 45 consist of:

- LH pillar with supports
- 5 horizontal beams
- RH pillar with supports

H 180 L 45 08902265

Per colonne H 204/216
For columns H 204/216

"MULTIPLO" ACCESSORI

"MULTIPLO" ACCESSORIES

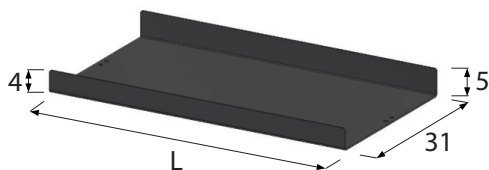

Mensola in metallo P 31 SP.2 mm verniciata a polvere
Metal shelf D 31 th.2 mm powder painted

L 45 08902374
L 55,8 08902375
L 85,8 08902378

Finiture disponibili

Available finishes



nero (opz.7892)
black (opt.7892)



silver dark (opz.9507)
dark silver (opt.9507)

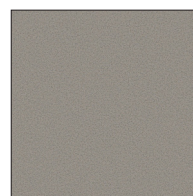

grigio selce (opz.SEL)
flint grey (opt.SEL)

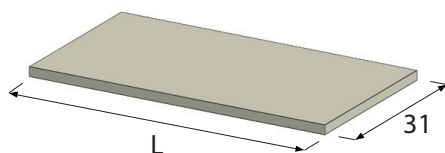

Mensola P 31 SP.18 mm finitura come anta

N.B.: per le finiture vedi pag.14-17

Shelf D 31 th.18 mm same finish as door

Note: for the finishes see page 14-17

MELAMINICO

MELAMINE

L 45 08902384
L 55,8 08902385
L 85,8 08902388

LACCATO OPACO

MATT LACQUERED

L 45 08902394
L 55,8 08902395
L 85,8 08902398

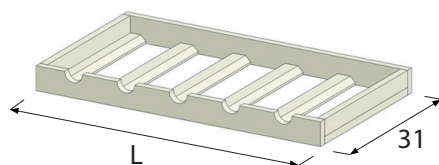

Portabottiglie in legno P 31 laccato a poro aperto
(completo di reggimensola a gradi)

Wood bottles rack D 31 open-pore lacquer
(complete with degree shelf brackets)

L 55,8 08902295
L 85,8 08902298

Finiture disponibili

Available finishes



nero (opz.7892)
black (opt.7892)

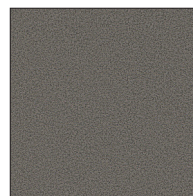

silver dark (opz.9507)
dark silver (opt.9507)



grigio selce (opz.SEL)
flint grey (opt.SEL)

“MULTIPLIO” PROFILI LED DUAL COLOR PER MONTANTI

“MULTIPLIO” DUAL COLOR LED PROFILES FOR PILLARS

Montanti SOTTOPENSILE

Pillars UNDER WALL UNIT

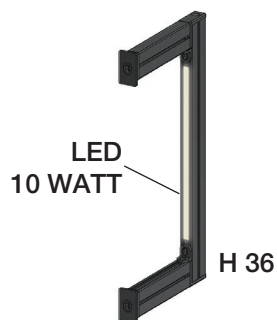

Montanti LIBRERIA A PARETE

Pillars WALL BOOKCASE

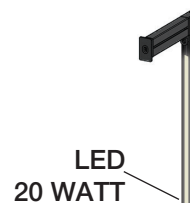
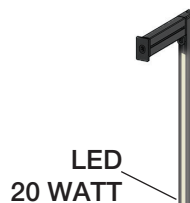

Montanti SOSPESO

Pillars HANGING

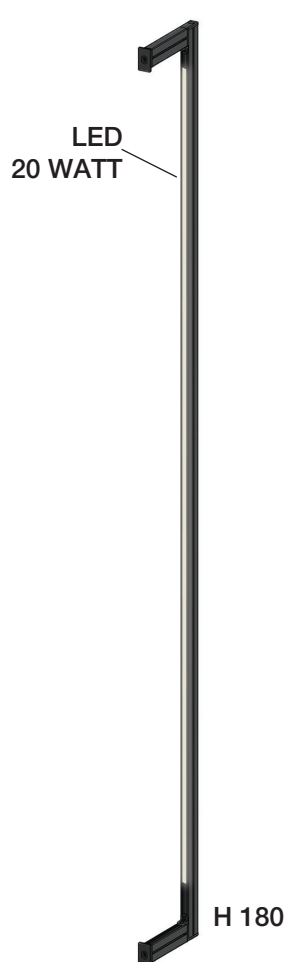
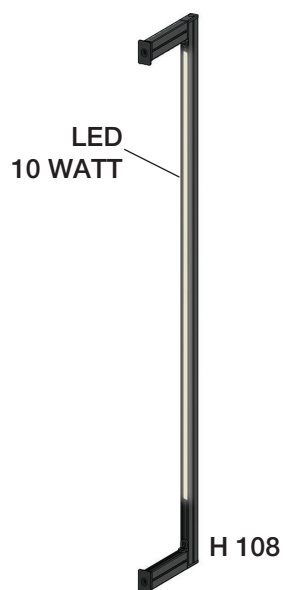

KIT ALIMENTATORI con telecomando e staffa/POWER SUPPLIES KIT with remote control and bracket



(max.4 ingressi)
(max.4 input)

Mercato UE/UE Market
- 30 WATT 08902350
- 100 WATT 08902351

Mercato Globale/Global Market -
- 30 WATT 08902352
- 100 WATT 08902353

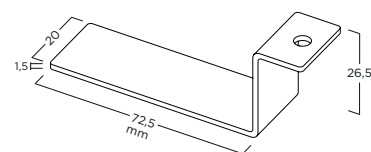

Staffa per alimentatore
(fissaggio sottomensola)
Bracket for power supply
(fixing on the bottom of the shelf)

"MULTIPLO" FINITURE MENSOLE SP.18 MM

"MULTIPLO" SHELVES FINISHES TH.18 MM

FINITURE MELAMINICHE - MELAMINE FINISHES

IMMAGINA



consiglio bianco
(opz.1561)



consiglio terra
bruciata (opz.1562)



consiglio grigio
fumo (opz.1563)



consiglio sabbia
(opz.1564)



consiglio champagne
(opz.1565)



larice baglia
(opz.1826)



larice laguna
(opz.1827)



larice vulcano
(opz.1828)



larice terra
(opz.1829)



noce
(opz.2363)



cemento
(opz.9633)

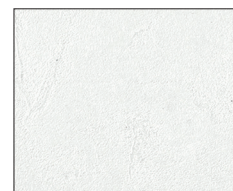

bianco cristallo
(opz.7445)

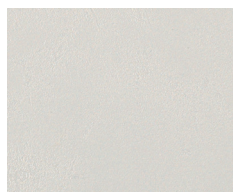

grigio nebbia
(opz.9626)



verde marino
(opz.8402)

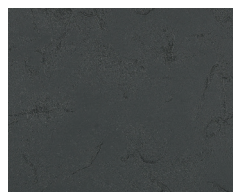

lavagna
(opz.9627)



juta
(opz.8863)

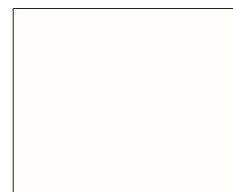

bianco assoluto
(opz.7441)

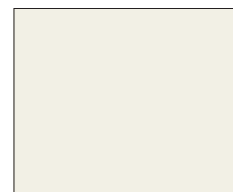

bianco neve
(opz.750)



grigio sasso
(opz.9650)

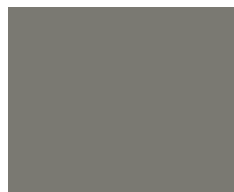

grigio monzone
(opz.9651)



grigio notte
(opz.9652)



grigio velo
(opz.9653)

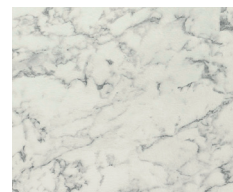

marmo baron
(opz.9632)



nichel
(opz.9660)

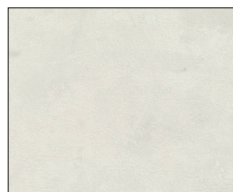

platino
(opz.9661)



zinco
(opz.9662)



peltro
(opz.9666)



titanio
(opz.9665)



olmo bianco
(opz.5001)



oak miele
(opz.1361)



oak neve
(opz.1362)



juta stone
(opz.9634)



grey stone
(opz.9635)



bronze stone
(opz.8869)



kea
(opz.9646)

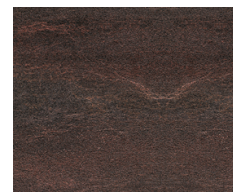

oxide
(opz.8871)



salix brown
(opz.1521)



salix grey
(opz.1522)



rovere chiaro
(opz.5325)



rovere duna
(opz.5326)



ables moka
(opz.4410)



ables bistro
(opz.4411)

"MULTIPLO" FINITURE MENSOLE SP.18 MM

"MULTIPLO" SHELVES FINISHES TH.18 MM

FINITURE MELAMINICHE - MELAMINE FINISHES

IMMAGINA



rovere grigio chiaro
(opz.5328)



rovere grafite
(opz.5327)



castagno bianco
(opz.3055)



marmo white yule
(opz.9645)

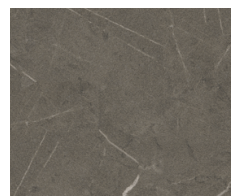

marmo venato grigio
(opz.8870)



ottone chiaro
(opz.7707)



rame brunito
(opz.8868)



rigatino orizzontale
arena (opz.96470)



rigatino orizzontale
laguna (opz.96480)

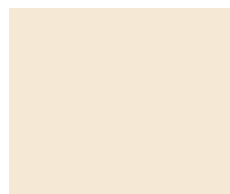

light cream
(opz.7706)

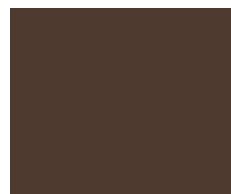

ebano
(opz.8872)

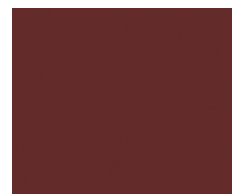

rosso cardinale
(opz.8123)

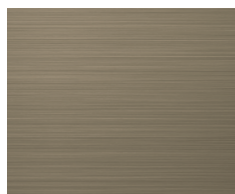

metal brass
(opz.8848) PET

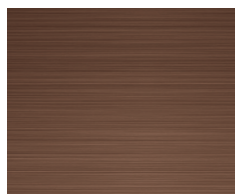

metal brown
(opz.8849) PET

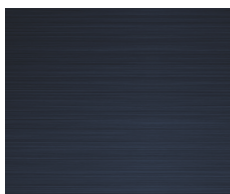

metal dark night
(opz.7871) PET

UNICA



phagos nuvola
(opz.1567)



phagos bianco
(opz.1566)

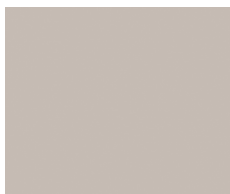

dove grey
(opz.8971)



phagos kapok
(opz.1560)



rovere perla
(opz.5314)



pietra grey
(opz.9642)



ecru
(opz.9641)



antracite
(opz.9643)



bianco assoluto
(opz.7450)

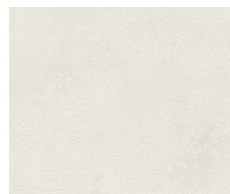

platino
(opz.9661)



phagos vulcano
(opz.1568)



pietra fulvus
(opz.8867)

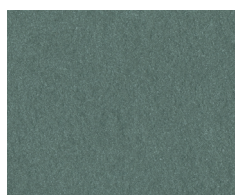

pietra musk
(opz.8403)

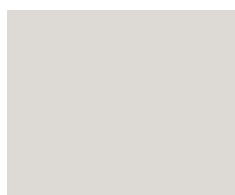

grigio chiaro
(opz.9640)

“MULTIPLLO” FINITURE MENSOLE SP.18 MM

“MULTIPLLO” SHELVES FINISHES TH.18 MM

FINITURE MELAMINICHE - MELAMINE FINISHES

TABLET



rovere luna
(opz.5316)



rovere venere
(opz.5315)



rovere arizona
(opz.5317)



rovere dark
(opz.5318)



frassino lava
(opz.2408)



frassino sabbia
(opz.2406)



frassino pietra
(opz.2407)



noce brown
(opz.2371)

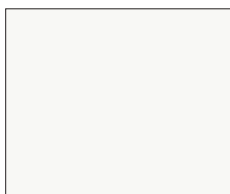

bianco
(opz.7447N)

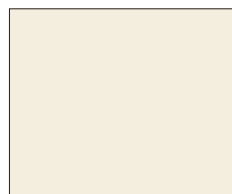

porcellana
(opz.7703N)



desert
(opz.8914N)



molara
(opz.9636N)



arena
(opz.9637N)



bianco
(opz.9639)



bronzo
(opz.8866)



ardesia
(opz.9638)



rovere tabià
(opz.5309)



rovere ortisei
(opz.5305)



trani
(opz.7704)

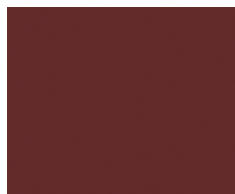

rosso cardinale
(opz.8123)

KYRA



abete nordico bianco
(opz.4406)



rovere naturale
vintage (opz.5310)



rovere bianco
(opz.5311)



rovere cipria
(opz.5312)

“MULTIPLO” FINITURE MENSOLE SP.18 MM

“MULTIPLO” SHELVES FINISHES TH.18 MM

FINITURE MELAMINICHE - MELAMINE FINISHES

JEY FEEL



rovere silver
(opz.5306)



rovere diamond
(opz.5307)



rovere tabià
(opz.5309)



rovere ortisei
(opz.5305)



trani
(opz.7704)



black
(opz.7863)

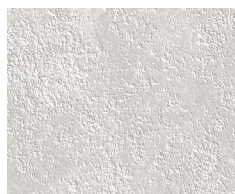

white
(opz.7448)



grigio agata
(opz.9623)

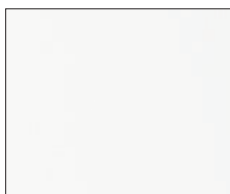

bianco assoluto
(opz.7441)



grigio inox
(opz.9624)

SMART



frassino bianco
alpino (opz.2310)



rovere greige
(opz.2320)



betulla
(opz.2311)

FINITURE LACCATE OPACHE - MATT LACQUERED FINISHES

Disponibili tutti i colori opachi del catalogo FINITURE LACCATE (GRUPPO LUBE)
Available all matt colours of the LACQUERED FINISHES catalogue (GRUPPO LUBE)

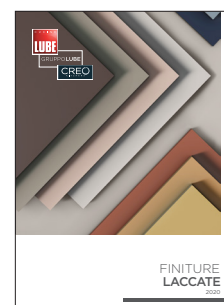

“MULTIPLO” ESEMPI DI COMPONENTABILITÀ

“MULTIPLO” EXAMPLES OF MODULARITY

ESEMPIO “MULTIPLO SOTTOPENSILE H 36 L 205”

EXAMPLE “MULTIPLO UNDER WALL UNIT H 36 W 205”

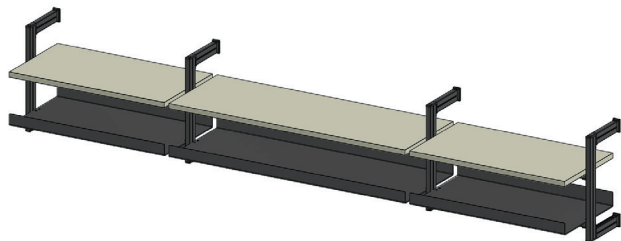

- **1 struttura singola H 36 L 60** 08902401
1 single structure H 36 W 60
- **1 struttura centrale H 36 L 87,9** 08902403C
1 central structure H 36 W 87,9
- **1 struttura centrale H 36 L 57,9** 08902401C
1 central structure H 36 W 57,9
- **2 mensole in melaminico P 31 L 55,8** 08902385
2 melamine shelves D 31 W 55,8
- **1 mensola in melaminico P 31 L 85,8** 08902388
1 melamine shelf D 31 W 85,8
- **2 mensole in alluminio P 31 L 55,8** 08902375
2 aluminium shelves D 31 W 55,8
- **1 mensola in alluminio P 31 L 85,8** 08902378
1 aluminium shelf D 31 W 85,8
- **Kit alimentatore 100 Watt (mercato UE)** 08902351
Power suppli kit 100 Watt (UE Market)
- **Maggiorazione kit luce led Dual Color** opz.002
Surcharge led light kit Dual Color

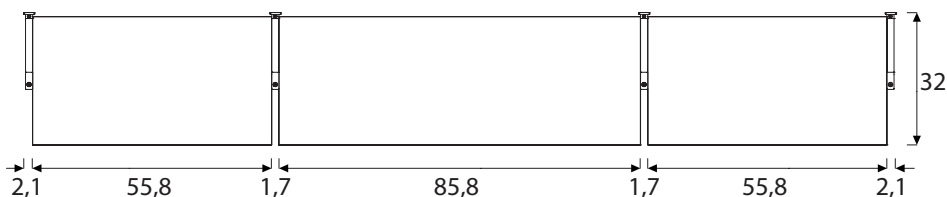

ESEMPIO “MULTIPLO SOSPESO H 108 L 117,5”

EXAMPLE “MULTIPLO HANGING H 108 W 117,5”

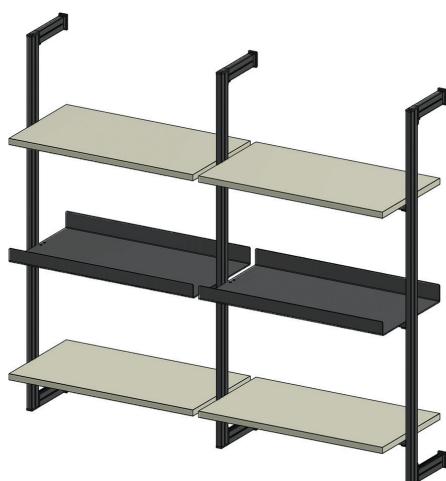

- **1 struttura singola H 108 L 60** 08902405
1 single structure H 108 W 60
- **1 struttura centrale H 108 L 57,9** 08902405C
1 central structure H 108 W 57,9
- **4 mensole in melaminico P 31 L 55,8** 08902385
4 melamine shelves D 31 W 55,8
- **2 mensole in alluminio P 31 L 55,8** 08902375
2 aluminium shelves D 31 W 55,8
- **Kit alimentatore 30 Watt (mercato UE)** 08902350
Power suppli kit 30 Watt (UE Market)
- **Maggiorazione kit luce led Dual Color** opz.002
Surcharge led light kit Dual Color

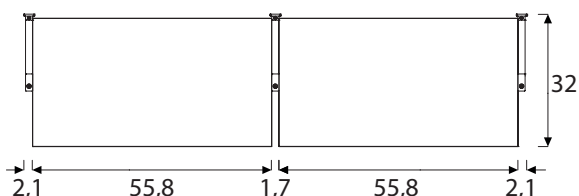

“MULTIPLO” ESEMPI DI COMPONENTABILITÀ

“MULTIPLO” EXAMPLES OF MODULARITY

ESEMPIO “MULTIPLO LIBRERIA A PARETE H 217 L 235”

EXAMPLE “MULTIPLO WALL BOOKCASE H 217 W 235”

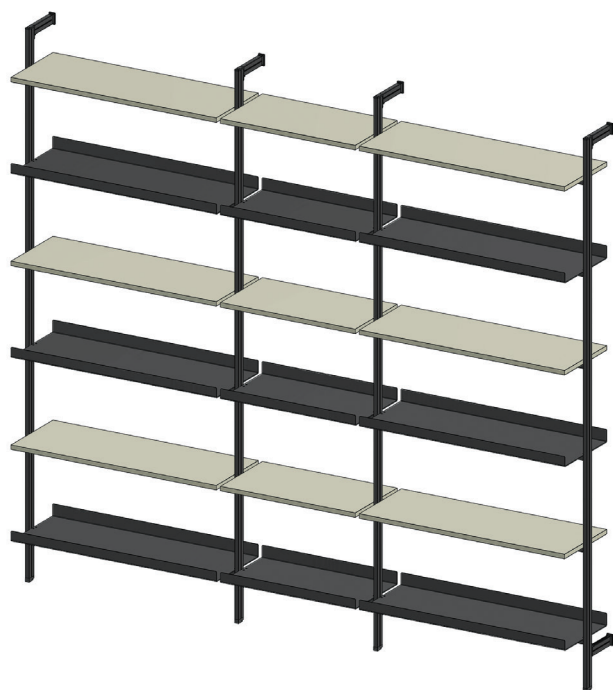

- **1 struttura singola H 217 L 90** 08902423
1 single structure H 217 W 90
- **1 struttura centrale H 217 L 57,9** 08902421C
1 central structure H 217 W 57,9
- **1 struttura centrale H 217 L 87,9** 08902423C
1 central structure H 217 W 87,9
- **6 mensole in melaminico P 31 L 85,8** 08902388
6 melamine shelves D 31 W 85,8
- **3 mensole in melaminico P 31 L 55,8** 08902385
3 melamine shelves D 31 W 55,8
- **6 mensole in alluminio P 31 L 85,8** 08902378
6 aluminium shelves D 31 W 85,8
- **3 mensole in alluminio P 31 L 55,8** 08902375
3 aluminium shelves D 31 W 55,8
- **Kit alimentatore 100 Watt (mercato UE)** 08902351
Power suppli kit 100 Watt (UE Market)
- **Maggiorazione kit luce led Dual Color** opz.002
Surcharge led light kit Dual Color

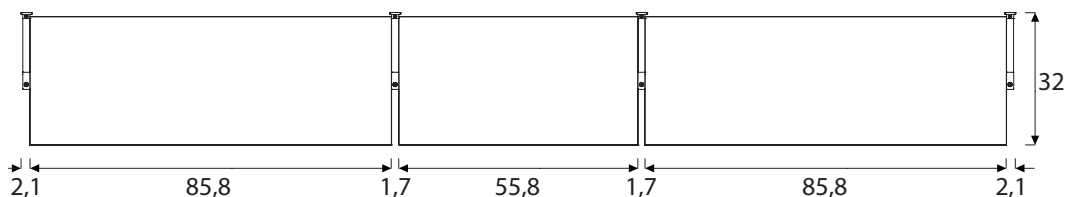

ESEMPIO “MULTIPLO TERMINALE H 180 L 49,2” per colonna H 204

EXAMPLE “MULTIPLO END UNIT H 180 W 49,2” for column H 204

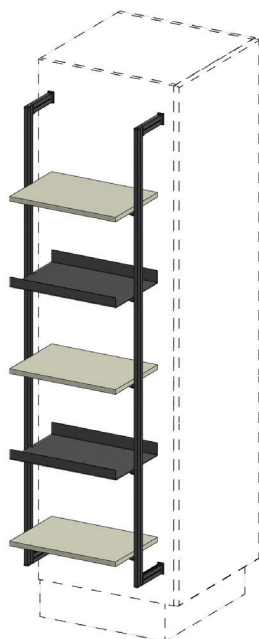

- **1 struttura terminale H 180 L 45** 08902265
1 end structure H 180 W 45
- **3 mensole laccate P 31 L 45** 08902394
3 lacquered shelves D 31 W 45
- **2 mensole in alluminio P 31 L 45** 08902374
2 aluminium shelves D 31 W 45

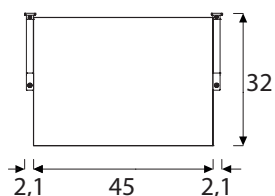

“MULTIPLO” ESEMPI DI COMPONENTABILITÀ

“MULTIPLO” EXAMPLES OF MODULARITY

ESEMPIO “MULTIPLO SOSPESO H 108 L 117,5”

EXAMPLE “MULTIPLO HANGING H 108 W 117,5”

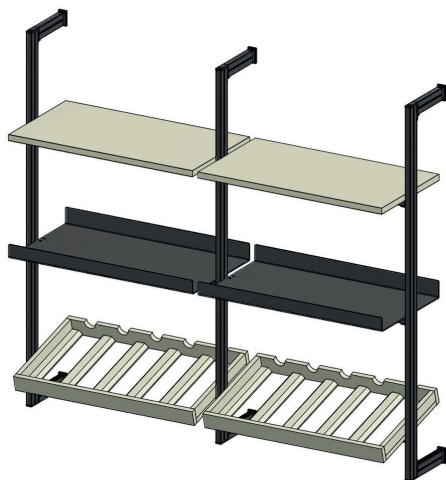

- 1 struttura singola H 108 L 60 08902405
1 single structure H 108 W 60
- 1 struttura centrale H 108 L 57,9 08902405C
1 central structure H 108 W 57,9
- 2 mensole in melaminico P 31 L 55,8 08902385
2 melamine shelves D 31 W 55,8
- 2 mensole in alluminio P 31 L 55,8 08902375
2 aluminium shelves D 31 W 55,8
- 2 portabottiglie in legno P 31 L 55,8 08902295
2 wood bottles rack D 31 W 55,8
- Kit alimentatore 30 Watt (mercato UE) 08902350
Power suppli kit 30 Watt (UE Market)
- **Maggiorazione kit luce led Dual Color** opz.002
Surcharge led light kit Dual Color

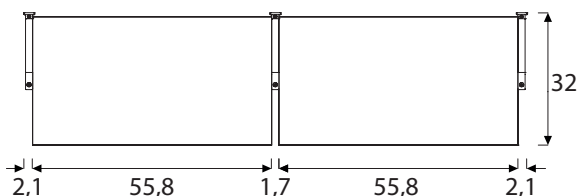

ESEMPIO “MULTIPLO LIBRERIA A PARETE H 217 L 235”

EXAMPLE “MULTIPLO WALL BOOKCASE H 217 W 235”

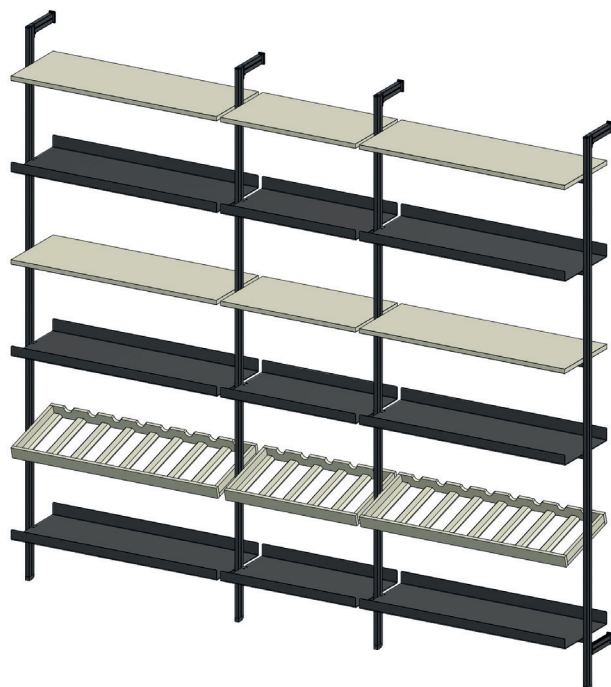

- 1 struttura singola H 217 L 90 08902423
1 single structure H 217 W 90
- 1 struttura centrale H 217 L 57,9 08902421C
1 central structure H 217 W 57,9
- 1 struttura centrale H 217 L 87,9 08902423C
1 central structure H 217 W 87,9
- 4 mensole in melaminico P 31 L 85,8 08902388
4 melamine shelves D 31 W 85,8
- 2 mensole in melaminico P 31 L 55,8 08902385
2 melamine shelves D 31 W 55,8
- 6 mensole in alluminio P 31 L 85,8 08902378
6 aluminium shelves D 31 W 85,8
- 3 mensole in alluminio P 31 L 55,8 08902375
3 aluminium shelves D 31 W 55,8
- 2 portabottiglie in legno P 31 L 85,8 08902298
2 wood bottles rack D 31 W 85,8
- 1 portabottiglie in legno P 31 L 55,8 08902295
1 wood bottles rack D 31 W 55,8
- Kit alimentatore 100 Watt (mercato UE) 08902351
Power suppli kit 100 Watt (UE Market)
- **Maggiorazione kit luce led Dual Color** opz.002
Surcharge led light kit Dual Color

