

smart. □



smart □





I VALORI IN CUI CREDIAMO: QUALITÀ, SICUREZZA E AMBIENTE

È nostra prassi quotidiana limitare l'impatto ambientale dei processi produttivi, gestendo le risorse non rinnovabili in modo corretto e in linea con le regolamentazioni vigenti. Lavoriamo per migliorare la qualità di processo e di prodotto a tutti i livelli della produzione.

THE **VALUES** WE BELIEVE IN: QUALITY, SAFETY AND ENVIRONMENTAL PROTECTION

It is our everyday practice to limit the environmental impact of the production processes, managing non-renewable resources properly and in line with current regulations. We work to improve process and product quality, at all levels of production.



Made in Italy
Mobile Italiano
Certificato N°19/2020

Made in Italy
Italian furniture origin
Certificate N°19/2020

100% MADE IN ITALY

La certificazione UNI 11674/2017 riconosce l'origine italiana dei nostri mobili per provenienza e per rispetto degli standard qualitativi. Quindi quando acquisti una nostra cucina sei sicuro di avere un prodotto controllato dalle origini alla gestione di tutte le fasi di fabbricazione secondo i requisiti richiesti e regolamentati. Sei sicuro di acquistare un prodotto dall'inconfondibile stile italiano ispirato alla cultura del saper fare.

100% MADE IN ITALY

The UNI 11674/2017 certification recognizes the Italian origin of our furniture and the compliance with quality standards. When you buy one of our kitchens, you can be assured you are purchasing a product that is controlled from the origins to the management of all manufacturing stages, according to the required and regulated standards. You can be assured you are buying a product that embodies the unmistakable Italian style, inspired by the know-how culture.



CERTIFICAZIONE GREENGUARD GOLD PER TUTTE LE STRUTTURE

La certificazione include criteri basati sull'impatto delle sostanze chimiche sulla salute umana, e richiede che i limiti di emissione dei COV totali siano tali da garantirne l'utilizzo anche in ambienti che richiedono particolari esigenze, come scuole e strutture sanitarie.

GOLD GREENGUARD CERTIFICATION FOR ALL THE STRUCTURES

This certification includes criteria based on the impact of chemicals on human health, and requires that the limitations on total VOCs emissions are such as to guarantee their use even in environments that call for special needs, such as schools and healthcare facilities.

L'idea di Smart: creare per chi la sceglie uno spazio cucina talmente personalizzato da definirlo unico, superando l'idea di "modello" e dando vita ad un'estetica innovativa oltre gli standard.

Smart si presenta con ante a telaio 18 mm di spessore, lo stesso delle ante lisce di Tablet, per avere due modelli completamente trasversali ed abbinabili tra loro. Nuova e ogni volta diversa così è Smart, una cucina da pensare liberamente secondo il proprio stile e le proprie esigenze.

smart □

The core idea behind Smart: to create, for those who choose it, a kitchen space customized enough to become unique, overcoming the idea of "model" and giving life to an innovative aesthetic, beyond the standards. Smart comes with 18 mm thick framed doors, the same thickness as the Tablet smooth doors, in order to have two models that are completely transversal and that can be combined with each other. New and different every time: this is the key feature of Smart, a kitchen to be freely conceived, according to one's own tastes and needs.





liscia o

a **telaiio**

smooth or frame





smart

18 MILLIMETRI: È SU QUESTO SPESSORE CHE SI GIOCA LA SCELTA TRA LE ANTE A TELAIO PROPRIE DI SMART O LE LISCE DI TABLET E MIXARLE INSIEME. UNA SCELTA CHE DÀ UNA VALENZA NUOVA AL PROGETTO CUCINA CHE SI DEFINISCE SEMPRE PIÙ PERSONALIZZATO.

il piacere di mixare
è **smart**

LE TANTISSIME FINITURE DISPONIBILI, SIA DI SMART SIA DI TABLET DA MIXARE A LORO VOLTA, OFFRONO LA POSSIBILITÀ DI **CREARE UN MODELLO UNICO**, FATTO SU MISURA PER LE ESIGENZE E SECONDO I GUSTI DI OGNUNO. PIÙ SMART DI COSÌ!

TAB LET

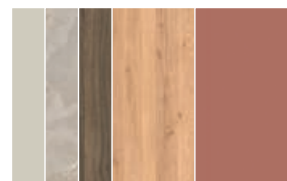

The pleasure of mixing is **smart**

18 Millimeters: it is on this thickness that **the choice is made between the framed doors featured in Smart or the smooth ones characterizing Tablet, as well as the possibility to mix them together.** A choice that gives a new value to the kitchen project, making it more and more personalized.

The large range of finishes available, both in Smart and In Tablet, to be mixed in turn, offer the possibility to create a unique model, customized according to one's own needs and tastes. It couldn't be any smarter!



smart. 



01

IL NUOVO FORNO DA 75 CM ABBINATO ALLA COLONNA FRIGO DELLA STESSA LARGHEZZA, PERMETTONO NUOVE SOLUZIONI ESTETICHE PER IL BLOCCO COLONNE E PIÙ FUNZIONALITÀ GRAZIE ALLA MAGGIORE CAPIENZA DELLE DISPENSE. IL BLOCCO BASI AVANZATO PERMETTE DI AVERE UN PIANO DI LAVORO PIÙ PROFONDO E ATTREZZABILE CON IL “MODULAR” A PARETE.

THE NEW 75 CM OVEN, COMBINED WITH THE FRIDGE COLUMN OF THE SAME WIDTH, OFFER NEW AESTHETIC SOLUTIONS FOR THE COLUMN BLOCK, AND PROVIDE MORE FEATURES, THANKS TO THE GREATER CAPACITY OF THE STORAGE SPACES. THE ADVANCED BLOCK OF BASE UNITS ALLOWS YOU TO HAVE A DEEPER WORKTOP, EQUIPPABLE WITH THE “MODULAR” WALL MOUNTED STORAGE SYSTEM.







L'introduzione della gola dona purezza alle basi valorizzandone la pulizia formale.

Leggero e di design l'accessorio "Modular".

The introduction of the groove handle enhances the purity and the formal cleanliness of the base units.

The "Modular" accessory stands out for its lightness and attractive design.



Scheda Tecnica / Technical Area



Smart anta PET carbone supermatt
(opz.9613)
Smart supermatt charcoal PET door
(opt.9613)



top laminato H4 ABS1 calce wraky
(opz.814)
H4 ABS1 wraky lime laminated top
(opt.814)



Tablet anta laccato UV
polvere opaco
(opz.9529)
Tablet matt powder UV
lacquered door
(opt.9529)

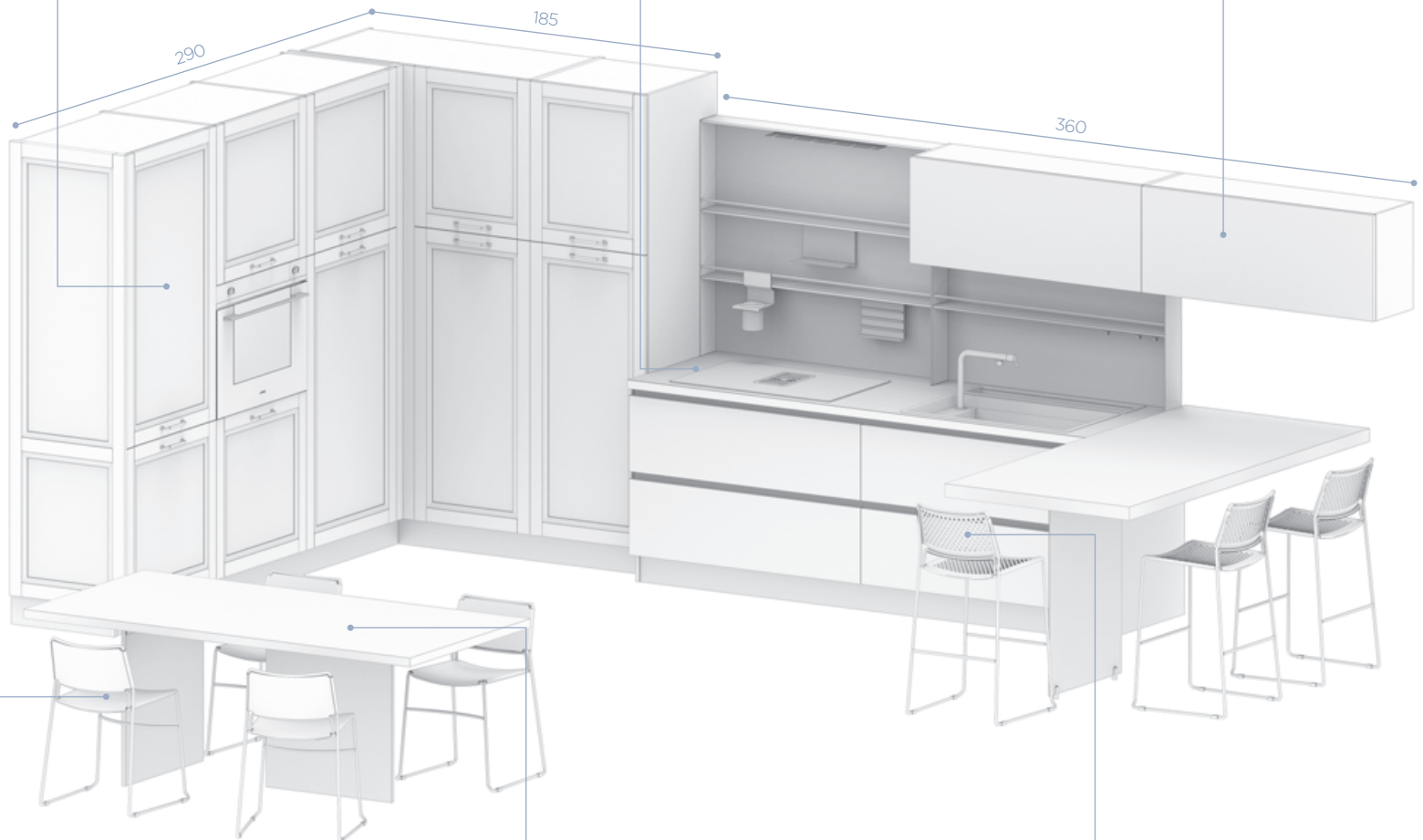

SEDIA - CHAIR

Slim - struttura oro rosa, con rivestimento
in cuoio rosa cipria
(opz.U64) (cod.084SMDO)
Slim - rose gold structure, with powder
pink leather upholstery
(opt.U64) (code 084SMDO)

TAVOLO - TABLE

Gler - 200x100 - struttura vetro trasparente
fumè, piano laminato H4 calce wraky
(opz.FM) (cod.08GE20L)
Gler - 200x100 - structure in smoked
transparent glass, H4 wraky lime laminated top
(opt. FM) (code 08GE20L)

SGABELLO - STOOL

Slim - struttura integrale metallo nero
(opz.ANE) (cod.084SMGM)
Slim - integral black metal structure
(opt.ANE) (code 084SMGM)

ZOCCOLO - PLINTH



H13 - alluminio verniciato ghisa opaco (opz.9509)
H13 - matt cast iron painted aluminum (opt.9509)

GOLA - FINGER RAIL



alluminio verniciato ghisa opaco (opz.9509)
cast iron painted aluminum (opt.9509)

CAPPA - HOOD

Faber - mod.Galileo - piano cottura con cappa
integrata
Faber - mod.Galileo - hob with integrated
hood



smart. □



02

COMPOSIZIONE A PENISOLA CHE SI APRE AL LIVING CON SOBRIA ELEGANZA. LE NUANCES DELICATE E CALDE CREANO UN'ATMOSFERA ACCOGLIENTE E SERENA. ALLE ANTE A TELAIO SI ACCOSTANO ANTE CON VETRO ED ACCESSORI HI-TECH, CONNUBIO PERFETTO TRA VOLUMI, TRAME E MATERIALI.

THE PENINSULA COMPOSITION OPENS TO THE LIVING ROOM WITH SOBER ELEGANCE. THE DELICATE AND WARM SHADES CREATE A COZY AND RELAXED ATMOSPHERE. THE COMBINATION OF FRAME DOORS, GLASS DOORS AND HI-TECH ACCESSORIES PROVIDES A PERFECT MATCH OF VOLUMES, TEXTURES AND MATERIALS.





Organizzazione perfetta grazie agli ampi spazi contenitivi delle basi.

Un angolo accogliente che unisce la zona operativa e quella conviviale con naturalezza e stile.

A perfect organization, thanks to the large storage spaces of the base units.

A cozy corner that connects the working area and the convivial one with naturalness and style.



Scheda Tecnica / Technical Area

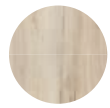

Smart anta betulla (opt.2311)
Smart birch door (opt.2311)

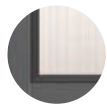

Smart anta metal dark (opt.2309)
Smart dark metal door (opt.2309)



top in laminato ABS1 H2 kaspio oro (opt.6089)
laminated top ABS1 H2 kaspio gold (opt.6089)

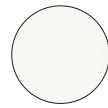

Smart anta PET gesso supermatt (opt.7604)
Smart supermatt gypsum PET door (opt.7604)

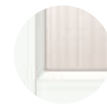

Smart anta vetro PET gesso supermatt (opt.7604)
Smart supermatt gypsum PET glass door (opt.7604)

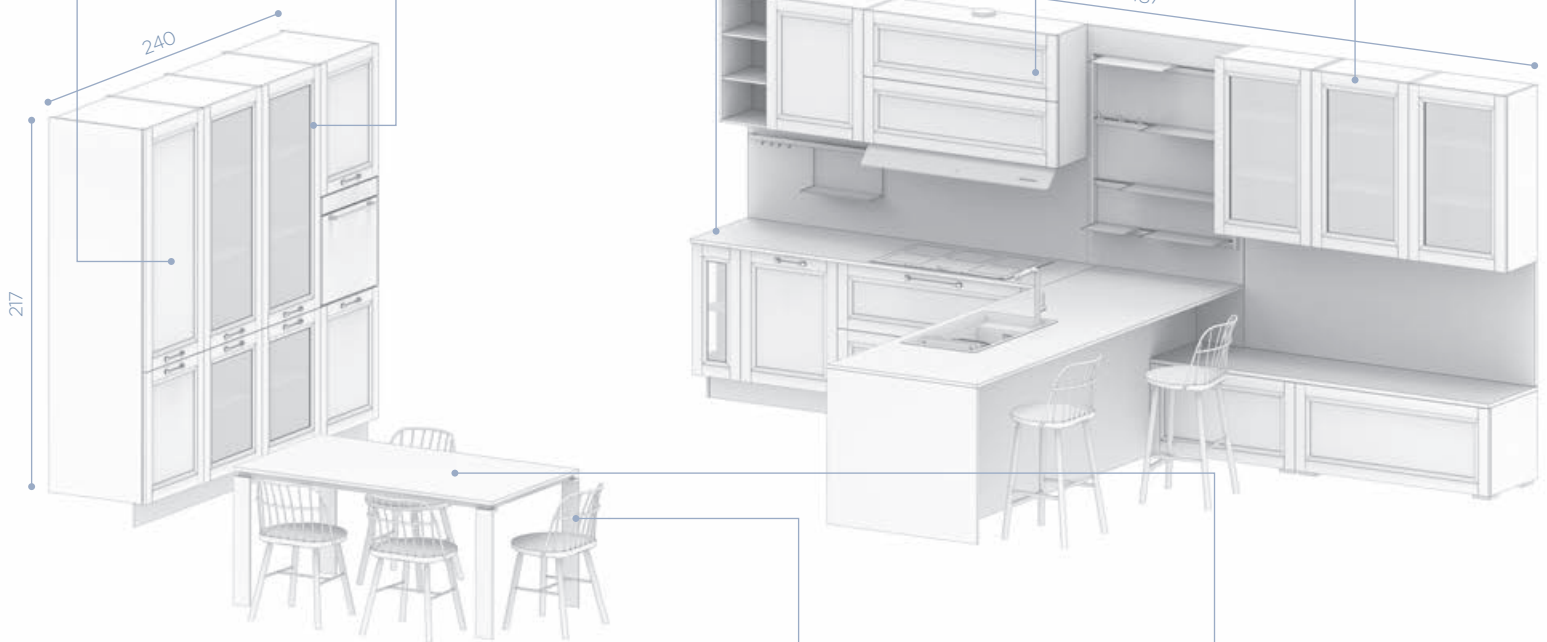

ZOCCOLO - PLINTH



H13 - alluminio finitura grigio selce (opt.SE)
H13 - flint gray aluminum finish (opt. SE)

MANIGLIA - HANDLE



K85 - finitura cromo satinato
K85 - satin chrome finish

SEDIA - CHAIR

Strike - struttura legno frassino tinto bianco, schienale metallo verniciato verde salvia (opt.K69) (cod.084TKDB)
Strike - white stained ash wood structure, sage green painted metal backrest (opt.K69) (code 084TKGB)

TAVOLO - TABLE

Venir - struttura metallo verniciato bianco, (opt.740) piano laminato Nichel (opt.9660)
Strike - white stained ash wood structure, sage green painted metal backrest (opt.K69) (code 084TKGB)



smart. □



03

L'ABBINAMENTO DI ANTE A TELAIO E LISCE DÀ UN EFFETTO DECORATIVO MOLTO INTERESSANTE E PIACEVOLE. NUOVI VOLUMI CON L'ALTERNANZA DI BASI A TERRA E SOSPENSE CHE CREANO UNA SENSAZIONE DI LEGGEREZZA E DI CONTEMPORANEITÀ, EVIDENZIATA ANCHE DAL NUOVO SISTEMA D'ARREDO "MULTIPLO".

THE COMBINATION OF FRAME AND SMOOTH DOORS GIVES A VERY INTERESTING AND ESTHETICALLY PLEASING DECORATIVE EFFECT. FLOOR AND SUSPENDED BASES ALTERNATE IN A COMPOSITION OF NEW VOLUMES, CREATING A FEELING OF LIGHTNESS AND CONTEMPORANEITY, ENHANCED ALSO BY THE NEW "MULTIPLO" FURNITURE SYSTEM.







L'accessorio "Multiplo" per completare e rendere funzionale anche il fianco della colonna.

The "Multiplo" accessory completes the composition while making the column side functional.



Scheda Tecnica / Technical Area

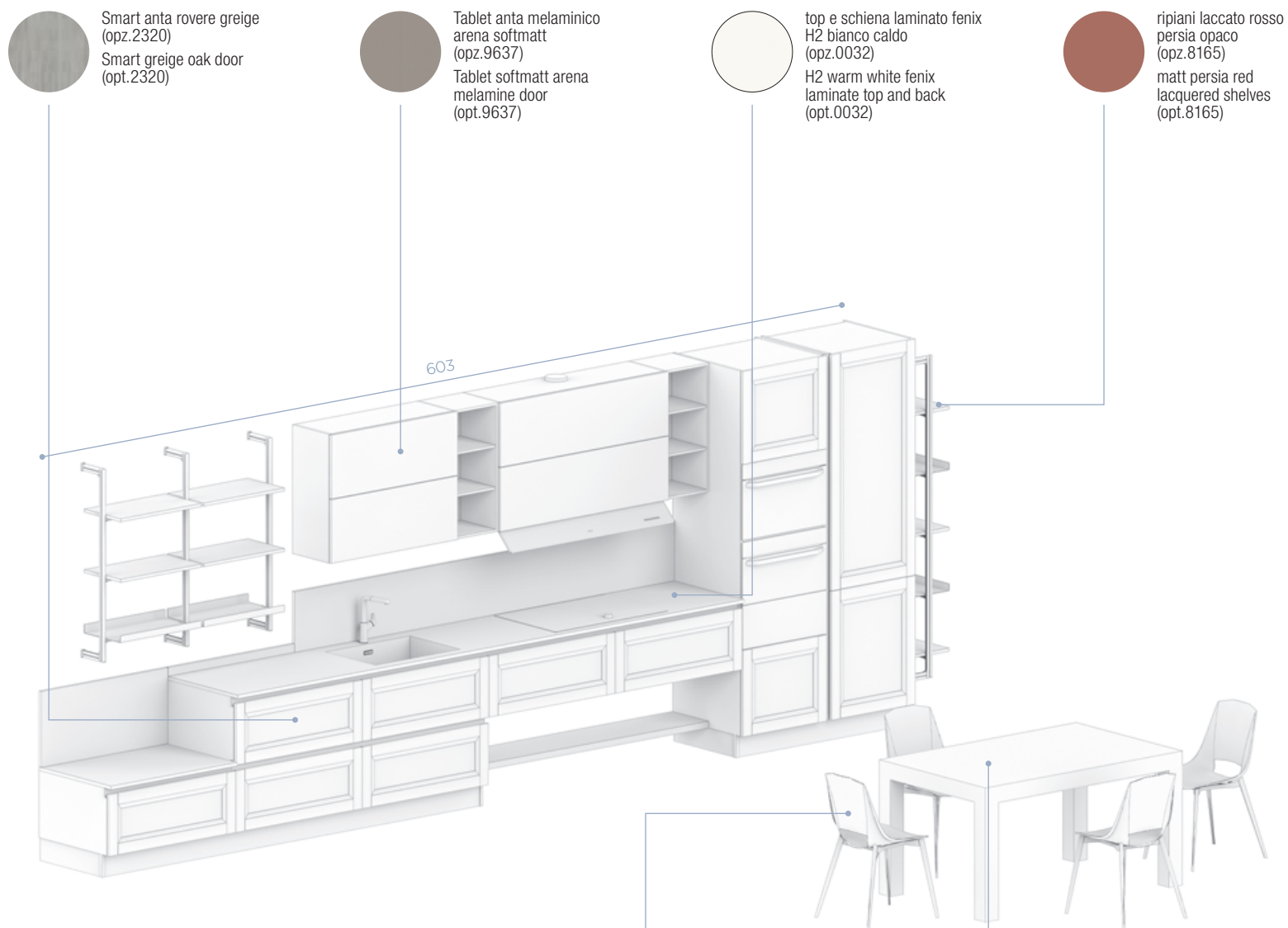

Smart anta rovere greige
(opt.2320)
Smart greige oak door
(opt.2320)

Tablet anta melaminico
arena softmatt
(opt.9637)
Tablet softmatt arena
melamine door
(opt.9637)

top e schiena laminato fenix
H2 bianco caldo
(opt.0032)
H2 warm white fenix
laminated top and back
(opt.0032)

ripianti laccato rosso
persia opaco
(opt.8165)
matt persia red
lacquered shelves
(opt.8165)

603

ZOCCOLO - PLINTH



H13 - alluminio finitura grigio selce (opt.SE)
H13 - flint gray aluminum finish (opt. SE)

GOLA - FINGER RAIL



alluminio grigio selce (opt.SEL)
flint gray aluminum (opt. SEL)

SEDIA - CHAIR

Vaden - struttura castoro (opt.22)
scoeca castoro (opt.E9)
(cod.084VDDV)
Vaden - beaver structure (opt.22)
beaver body (opt.E9)
(code 084VDDV)

TAVOLO - TABLE

Spirit - 160x90 - struttura e piano
in laminato fenix beige arizona
(opt.0748) (cod.08PT16L)
Spirit - 160x90 - structure and top in
arizona beige fenix laminate
(opt.0748) (code 08PT16L)



smart. □



04

SEMPLICE, LINEARE, PULITA. L'ELEMENTO A GIORNO RAPPRESENTA IL TRAIT D'UNION IDEALE TRA LA CUCINA E L'AMBIENTE LIVING. LE ANTE A TELAIO HANNO UN SAPORE DI CLASSICITÀ RIVISITATA IN CHIAVE MODERNA E SOFISTICATA, RESA ANCORA PIÙ ATTUALE DAI PENSILI IN FINITURA MALTA ARDESIA.

SIMPLE, LINEAR, CLEAN. THE OPEN COMPARTMENT REPRESENTS THE IDEAL TRAIT D'UNION BETWEEN THE KITCHEN AND THE LIVING ENVIRONMENT. THE CLASSIC-STYLE FRAME DOORS ARE REDESIGNED WITH A CONTEMPORARY AND REFINED TWIST, MADE EVEN MORE CONTEMPORARY BY THE WALL UNITS IN SLATE CEMENT FINISH.







Living dagli ampi spazi contenitivi, particolare rivisitazione moderna della vetrina che cattura l'attenzione e rende protagonisti gli oggetti.

Ampio piano di lavoro con top in laminato effetto marmo Baron.



The living room features large storage spaces, a particular modern reinterpretation of the showcase that captures the attention and makes the objects the true protagonists of the space.

Large countertop with Baron marble-effect laminate top.

Scheda Tecnica / Technical Area



Smart anta metal dark
opt. 2309
Smart dark metal door
(opt. 2309)



Smart anta frassino
bianco alpino
(opt. 2310)
Smart alpine white
ash door
(opt. 2310)

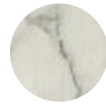

top laminato ABS1 H4
marmo baron
(opt. 9632)
H4 ABS1 baron marble
laminate top
(opt. 9632)



Tablet anta malta ardesia
(opt. 9638)
Tablet slate mortar door
(opt. 9638)

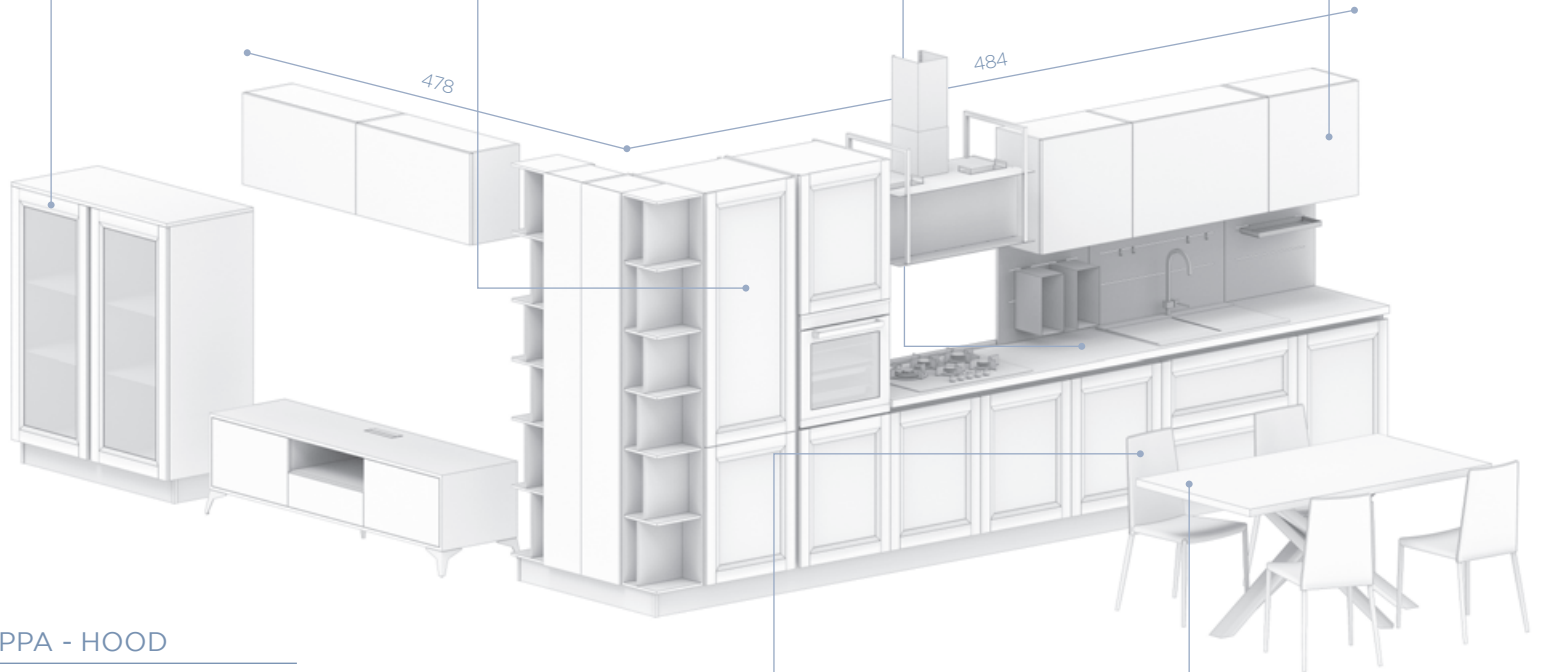

CAPPA - HOOD

K - design - mod. Farm - L.90 - finitura silver dark
K - design - mod. Farm - L.90 - silver dark finish

ZOCCOLO - PLINTH



H13 - alluminio finitura silver dark (opt. 9507)
H13 - aluminum silver dark finish (opt. 9507)

GOLA - FINGER RAIL

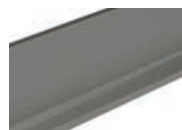

gola alluminio verniciata a polvere silver dark
(opt. 9507)
dark silver powder coated aluminum groove
(opt. 9507)

SEDIA - CHAIR

Basad - cuoio rigenerato grigio piombo
(opt. R16) (cod. 084BSD)
Basad - lead gray regenerated leather
(opt. R16) (code 084BSD)

TAVOLO - TABLE

Kuset - 180x100 - fisso struttura silver dark
(opt. 9507)
piano laminato marmo baron
(opt. 9632) (cod. 08KUF18L)
Kuset - 180x100 - fixed structure dark silver
(opt. 9507)
baron marble laminate top
(opt. 9632) (code 08KUF18L)

LIVING

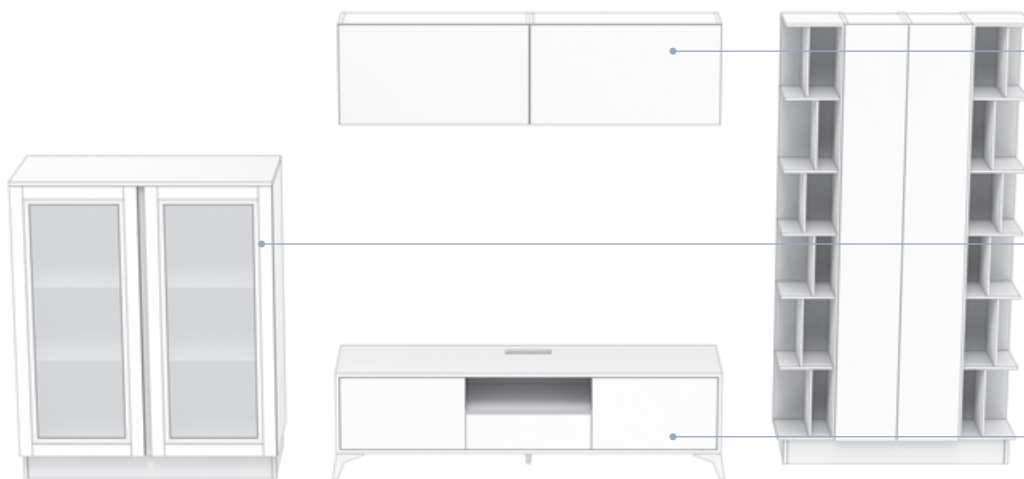

Tablet anta malta ardesia
(opt. 9638)
Tablet slate mortar door
(opt. 9638)



Smart anta metal dark
(opt. 2309)
Smart dark metal door
(opt. 2309)



madia mixo malta ardesia
mixo slate mortar cupboard

123

355



smart. □



05

LA CUCINA ACQUISTA SPAZIO VERTICALE CON UNA PROGETTAZIONE A TUTTA ALTEZZA DATA DALLA PARETE A COLONNE CON SOPRACOLONNE. RAGGIUNGE UN EQUILIBRIO COMPOSITIVO E CROMATICO GRAZIE ALL'ABBINAMENTO DI NUANCES MATERICHE E CALDE DEGLI ALTRI ELEMENTI.

THE KITCHEN GAINS VERTICAL SPACE THANKS TO A FULL-HEIGHT DESIGN, PROVIDED BY THE COLUMN WALL WITH UPPER COLUMNS. THE COMPOSITIONAL AND CHROMATIC BALANCE IS ACHIEVED THROUGH THE PAIRING OF MATERIAL AND WARM SHADES OF THE OTHER ELEMENTS.







Living contemporaneo ed essenziale, basi sospese minimali ed elementi contenitivi verticali uniti ai pensili in vetro.

Giochi di volumi. Particolare l'effetto del blocco colonne forno sospese.

A contemporary and essential living room, minimal suspended bases and vertical storage elements, combined with glass wall units.

A play of volumes. The suspended oven column block creates a peculiar effect.

Scheda Tecnica / Technical Area

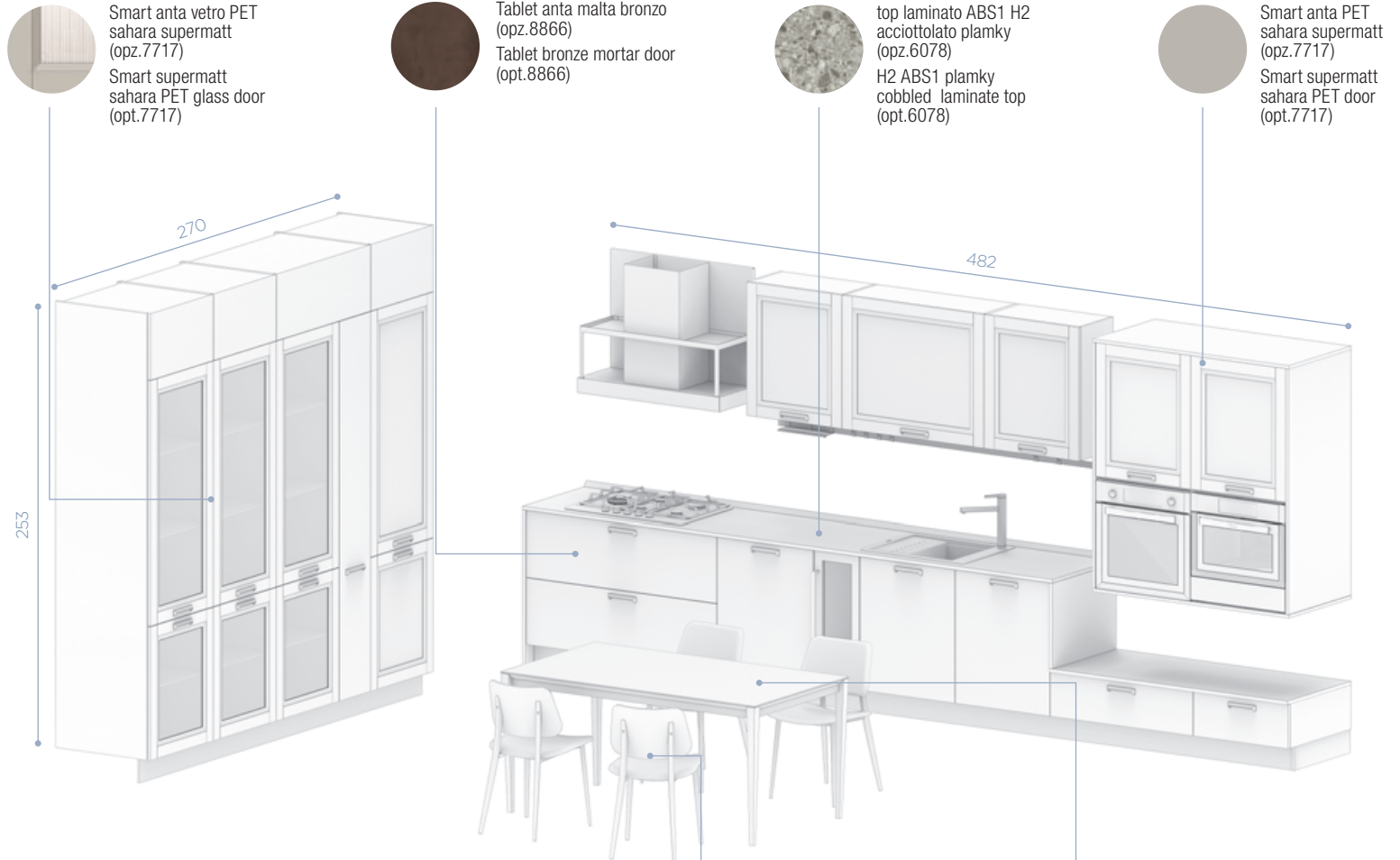

CAPPA - HOOD

Artel - mod.Etra - L.90 - finitura ghisa
 Artel - mod.Etra - L.90 - cast iron finish

ZOCCOLO - PLINTH



H13 - alluminio verniciato ghisa opaco (opt.9509)
 H13 - matt cast iron painted aluminum (opt.9509)

MANIGLIA - HANDLE



K90 - finitura bronzo
 K90 - bronze finish

SEDIA - CHAIR

Joe - struttura grigio kenya, rivestimento cuoio rigenerato bistro (opt.Z41) (cod.084JODKC)
 Joe - kenya grey structure, bistro regenerated leather upholstery (opt.Z41) (code 084JODKC)

TAVOLO - TABLE

Lend - 160x90 - struttura metallo verniciato nero (opt.07)
 piano laminato acciottolato (opt.6078) (cod.08ND16L)
 Lend - 160x90 - black painted metal structure (opt.07)
 cobbled laminate top (opt.6078) (code 08ND16L)

LIVING

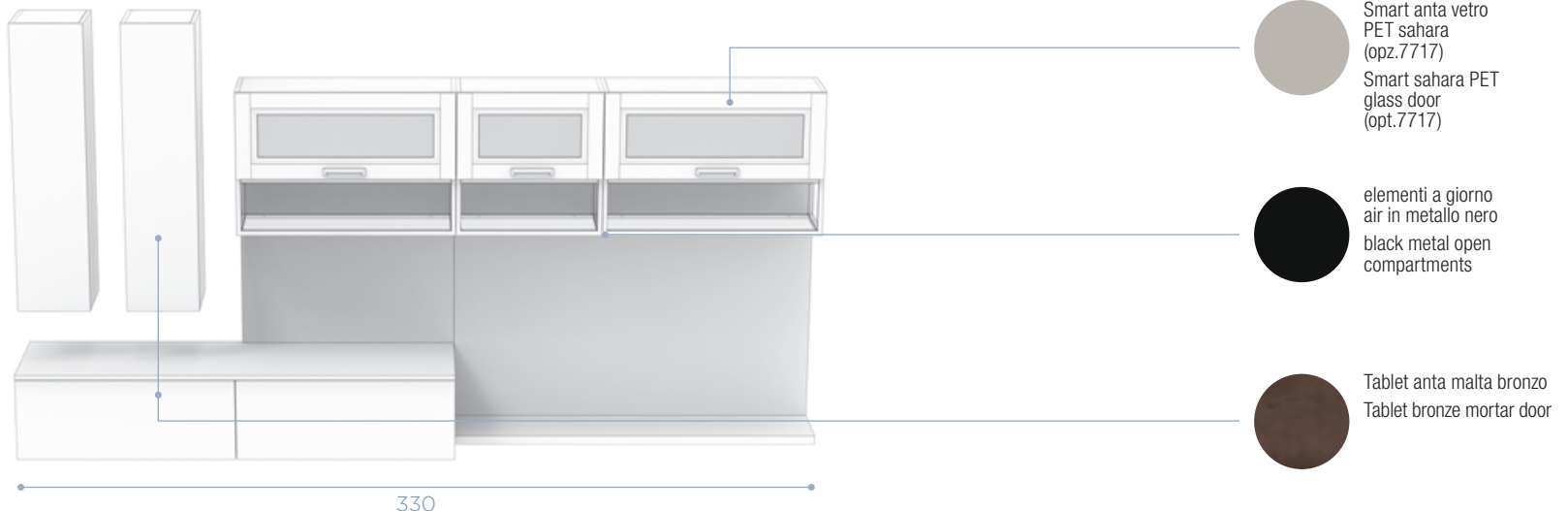

330



smart. □



06

LA CUCINA SI INTEGRA AL LIVING CREANDO UN AMBIENTE MOLTO OSPITALE. DINAMICA CON LA PENISOLA CHE SI CHIUDE CON UN ELEGANTE TAVOLO SNACK RIBASSATO RISPETTO AL PIANO LAVORO. RICCA E LEGGERA GRAZIE ALLE MENSOLE CHE COMPLETANO, INSIEME AI PENSILI A VETRO, LA ZONA OPERATIVA. IL BLOCCO COLONNE È RIPENSATO CON ELEGANTI TERMINALI A GIORNO.

THE KITCHEN BECOMES ONE WITH THE LIVING AREA, CREATING AN EXTREMELY INVITING ENVIRONMENT. DYNAMIC WITH A PENINSULA CULMINATING IN AN ELEGANT AND LOWER SNACK COUNTER, COMPARED TO THE WORKTOP. PROSPEROUS AND LIGHT THANKS TO THE SHELVES THAT COMPLETE, TOGETHER WITH THE GLASS WALL UNITS, THE OPERATIONAL AREA. THE BLOCK OF COLUMNS HAVE BEEN DESIGNED WITH ELEGANT END OPEN UNITS.







Pensili con ante a vetro e mensole donano leggerezza e allo stesso tempo possibilità organizzativa.

Living essenziale con base sospesa, elementi a giorno in metallo e pensili a vetro con luce a led dimmerabile.

Wall units with glass doors and shelves add lightness and organizational possibility at the same time.

An essential living room with wall-hung base unit, metal open units and glass wall units with dimmable LED light.



Scheda Tecnica / Technical Area

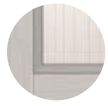

Smart anta metal lux
(opt.2300)
Smart lux metal door
(opt.2300)



Smart frassino bianco alpino
(opt.2310)
Smart alpine white ash door
(opt.2310)



top okite H3 verde oriente
(opt.1801)
H3 orient green okite top
(opt.1801)



penisola laminato
ABS1 H6 marmo nuvolato
(opt.6074)
H6 ABS1 penisola
lamine cloudy marble
(opt.6074)

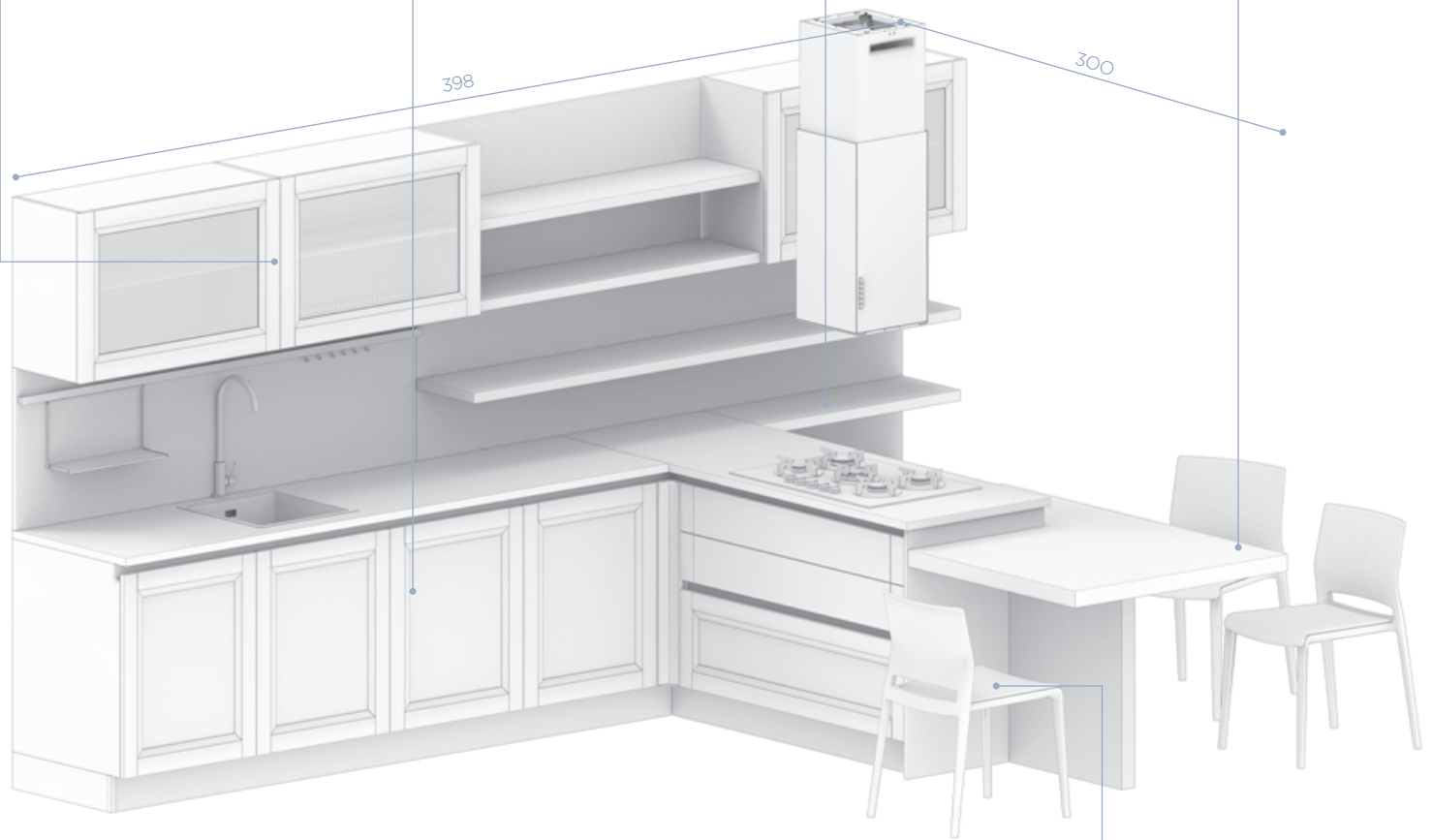

ZOCCOLO - PLINTH



H13 - alluminio verniciato ghisa (opt.9509)
H13 - cast iron painted aluminum (opt.9509)

GOLA - FINGER RAIL



alluminio verniciato ghisa (opt.9509)
cast iron painted aluminum (opt.9509)

CAPPA - HOOD

Elica - mod.Haiku isola - L.32 - finitura black
Elica - mod.Haiku isola - L.32 - black finish

SEDIA - CHAIR

Keta - con cuscino struttura tecnopolimero
salvia (opt.51)
seduta ecopelle vaniglia (opt.02) (cod.084KTDI)
Keta - with sage technopolymer structure
cushion (opt.51)
vanilla eco-leather seat (opt.02) (code 084KTDI)

LIVING



Smart anta metal lux
(opt.2300)
Smart lux metal door
(opt.2300)



elemento a giorno air
in metallo nero
black metal open
compartment

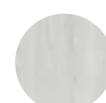

Smart anta frassino
bianco alpino
(opt.2310)
Smart alpine white ash door
(opt.2310)

330



smart. □



07

CUCINA COMPATTA, RICCA DI ELEMENTI CONTENITIVI. LINEARE E SEMPLICE, CLASSICA MA CONTEMPORANEA GRAZIE AGLI ELEMENTI A GIORNO CHE SPEZZANO IL RIGORE COMPOSITIVO DONANDO UN TOCCO DI COLORE. NUOVA LA COMPOSIZIONE SOSPESA CON ELEMENTI A GIORNO E PENSILI CHE LA DEFINISCONO.

A COMPACT KITCHEN, RICH IN STORAGE UNITS. LINEAR AND SIMPLE, CLASSIC YET CONTEMPORARY, THANKS TO THE OPEN COMPARTMENTS THAT BREAK THE COMPOSITIONAL RIGOR, ADDING A TOUCH OF COLOR. AMONG THE INNOVATIONS, THE SUSPENDED COMPOSITION FEATURING OPEN AND WALL UNITS .







Living con ampia base a terra, sobrio e minimale. Pensili a vetro abbinati ai sistemi d'arredo "Air Line" lo completano.

Composizione sospesa multifunzione con ampi spazi contenitivi.

A sober and minimal living room, with a large ground base. The glass wall units, combined with the "Air Line" furnishing systems, complete it.

Multifunction suspended composition with wide storage spaces.

Scheda Tecnica / Technical Area

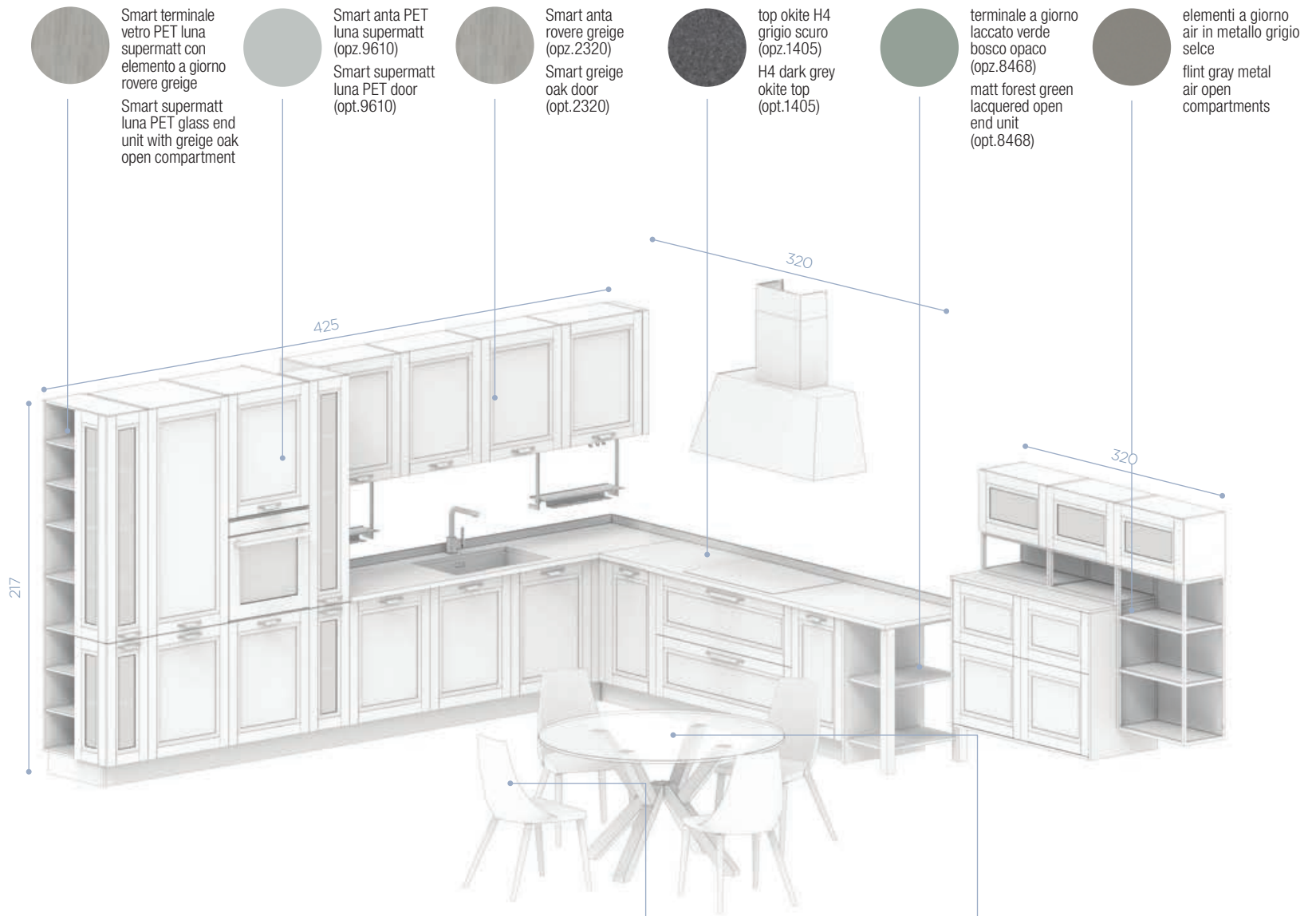

ZOCCOLO - PLINTH



H13 - alluminio finitura grigio selce (opt.SE)
H13 - flint gray aluminum finish (opt. SE)

MANIGLIA - HANDLE



K92 - finitura grigio selce
K92 - flint gray finish

SEDIA - CHAIR

Dhaga - struttura e seduta sabbia (opt.240SAB) (cod.084DHD)
Dhaga - sand structure and seat (opt.240SAB) (code 084DHD)

TAVOLO - TABLE

Mek - 140 - vetro fisso trasparente (opt.TR) (cod.08EK14V)
Mek - 140 - transparent fixed glass (opt.TR) (code 08EK14V)

LIVING

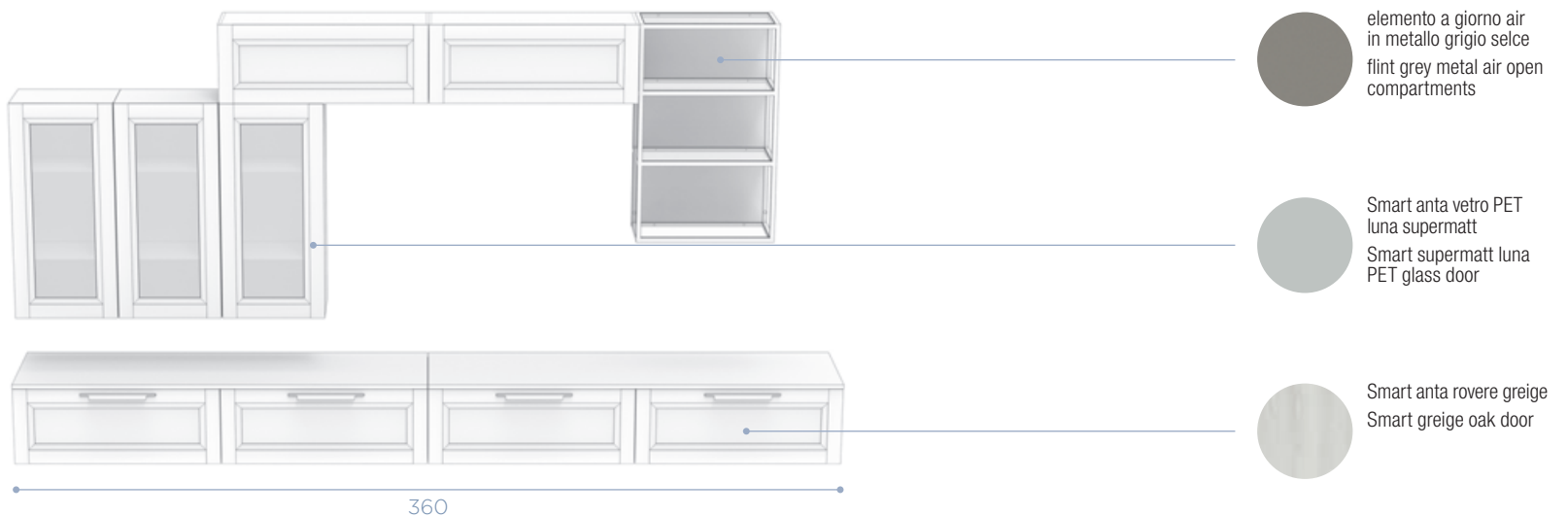



smart. 



08

UNA COMPOSIZIONE AMPIA E LUMINOSA CHE SI AFFACCIA SUL LIVING CREANDO UNO SPAZIO APERTO E CONFORTEVOLE. LINEE ESSENZIALI, GEOMETRIE LIMPIDE CARATTERIZZATE DALLE ANTE A TELAIO. VETRINE IN PET, TIPICHE DI SMART.

A LARGE AND BRIGHT COMPOSITION THAT OVERLOOKS THE LIVING, CREATING AN OPEN AND COMFORTABLE SPACE. ESSENTIAL LINES, CLEAR GEOMETRIES FEATURING FRAME DOORS. PET GLASS CABINETS, TYPICAL OF SMART.







Ogni cosa al suo posto, grazie a cassetti e cestoni attrezzati con i numerosi accessori interni.

Funzionale e moderno il piano snack completato con la presa elettrica a scomparsa.

Everything in its place, thanks to the drawers and deep drawers equipped with many interior accessories.

The snack top, equipped with a retractable electrical outlet, is functional and modern.

Scheda Tecnica / Technical Area



penisola laminato ABS1
H6 marmo nuvolato plamky
(opt.6074)
plamky cloudy marble ABS1
H6 laminate peninsula laminate
(opt.6074)



top laminato ABS1
H4 bardiglio plamky
(opt.6075)
plamky bardiglio ABS1
H4 laminate top
(opt.6075)



Smart anta PET gesso
supermatt
(opt.7464)
Smart supermatt
gypsum PET door
(opt.7464)



Smart anta
frassino bianco alpino
(opt.2310)
Smart Alpine white
ash door
(opt.2310)

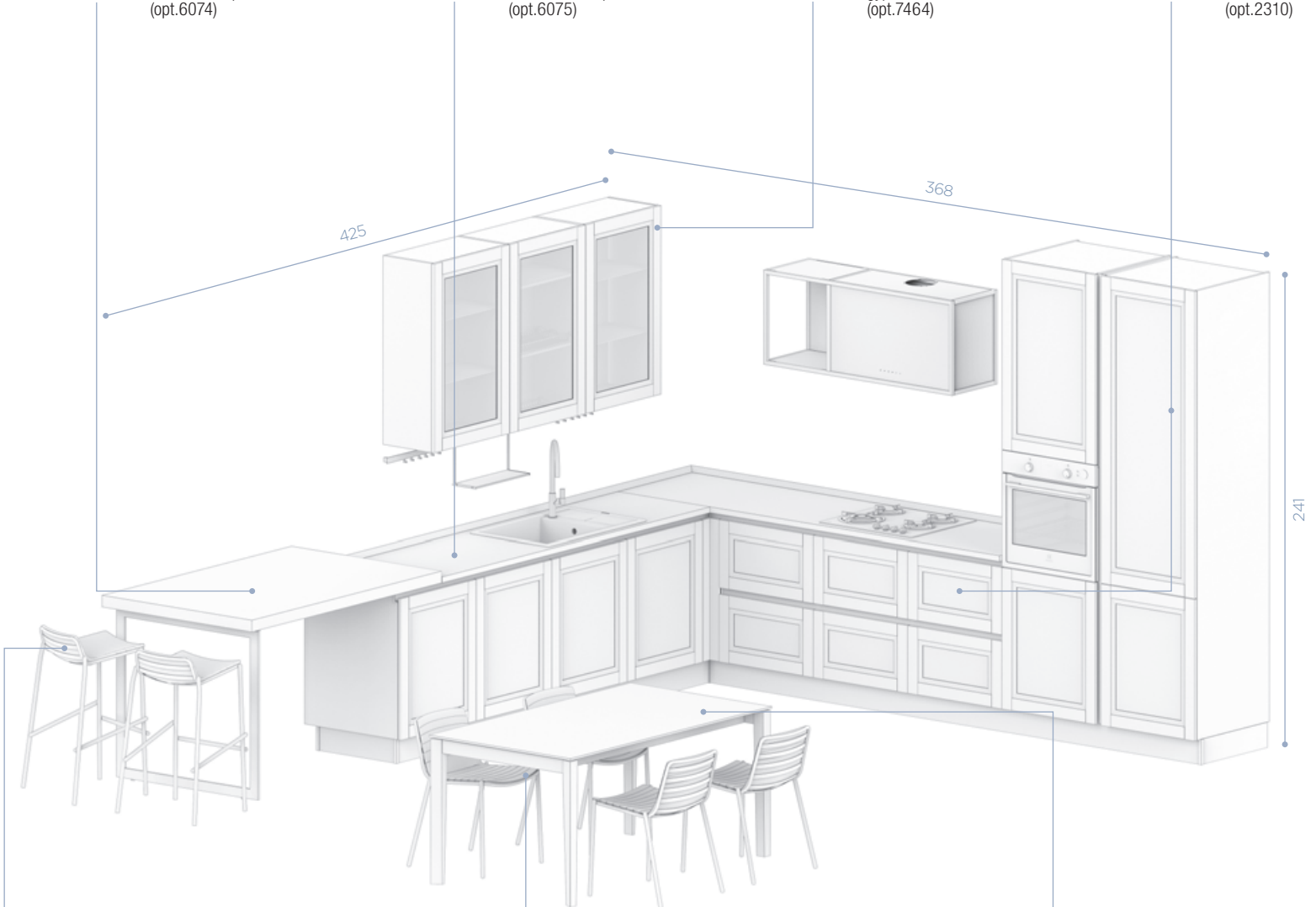

SGABELLO - STOOL

Trampoliere - struttura metallo verniciato azzurro (opt.B)
seduta ecopelle cenere
(opt.7SF) (cod.084AWGIE)
Trampoliere - light blue painted metal structure (opt. B)
ash eco-leather seat
(opt.7SF) (code 084AWGIE)

SEDIA - CHAIR

Trampoliere - struttura metallo verniciato azzurro (opt.B)
seduta ecopelle cenere
(opt.7SF) (cod.084AWDIE)
Trampoliere - light blue painted metal structure (opt. B)
ash eco-leather seat
(opt.7SF) (code 084AWDIE)

TAVOLO - TABLE

Univers - 160x90 - struttura silver dark
(opt.9550)
piano ceramico arabesco opaco finitura
cava (opt.G90L) (cod.08UV16C)
Univers - 160x90 - silver dark structure
(opt.9550)
matt arabesque ceramic top finish
(opt.G90L) (code 08UV16C)

ZOCCOLO - PLINTH



H13 - alluminio finitura silver dark (opt.9507)
H13 - aluminum silver dark finish (opt.9507)

GOLA - FINGER RAIL

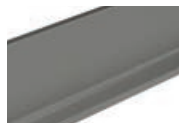

gola alluminio verniciata a polvere silver dark
(opt.9507)
dark silver powder coated aluminum groove
(opt.9507)

CAPPA - HOOD

K - design - mod.Frame - L.120
finitura silver dark
K - design - mod.Frame - L.120
dark silver finish



smart. □



09

ACCOSTAMENTI A CONTRASTO TRA LA NATURALITÀ DELLA FINITURA BETULLA E IL COLORE, TRA LE ANTE LISCE E A TELAIO. LA PERSONALITÀ DELLA CUCINA È DATA DA QUESTO SAPIENTE MIX, PURO CONCENTRATO DI CREATIVITÀ E FUNZIONALITÀ.

CONTRASTING COMBINATIONS BETWEEN NATURAL BIRCH FINISH AND COLOR, BETWEEN SMOOTH AND FRAMED DOORS. THE KITCHEN DISTINCTIVE CHARACTER LIES IN THIS SKILLFUL MIX, A PURE CONCENTRATE OF CREATIVITY AND FUNCTIONALITY.







Particolare del nuovo mobile in appoggio con anta apribile con meccanismo "Winch".

Living contemporaneo con il nuovo sistema d'arredo "Multiplo" (disponibile anche con luci incorporate nella struttura) abbinata a basi sospese e pensili a vetro. Di carattere grazie all'elemento colore.

A detail of the new support piece of furniture with door featuring "Winch" opening mechanism.

A contemporary living room designed with the new "Multiplo" furnishing system (also available with lights incorporated in the structure) combined with suspended base units and glass wall units. A project with such a great features, thanks to the colorful elements



Scheda Tecnica / Technical Area



Tablet anta rosso cardinale
(opt.8123)
Tablet cardinal red door
(opt.8123)

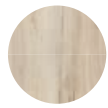

Smart anta betulla
(opt.2311)
Smart birch door
(opt.2311)

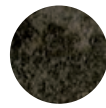

top stratificato HPL SP. 1,2
ossido cuore nero
(opt.3690)
HPL SP stratified top 1,2
oxide black core
(opt.3690)



elemento a giorno
laccato bistrò opaco
(opt.9535)
matt bistrò lacquered
open compartment
(opt.9535)



ZOCCOLO - PLINTH



H13 - alluminio ghisa (opt.9509)
H13 - cast iron painted aluminum (opt.9509)

MANIGLIA - HANDLE



K93 - finitura ghisa
K93 - cast iron finish

SEDIA - CHAIR

Veivor - struttura in resina
(opt.50ANT) (cod.084VVD)
Veivor - resin structure
(opt.50ANT) (code 084VVD)

TAVOLO - TABLE

Lend - 160x90 - struttura metallo nero
(opt.07)
piano HPL ossido cuore nero (opt.3690)
(cod.08ND16L)
Lend - 160x90 - black painted metal
structure (opt.07)
black core oxide HPL top
(opt.3690) (code 08ND16L)

LIVING

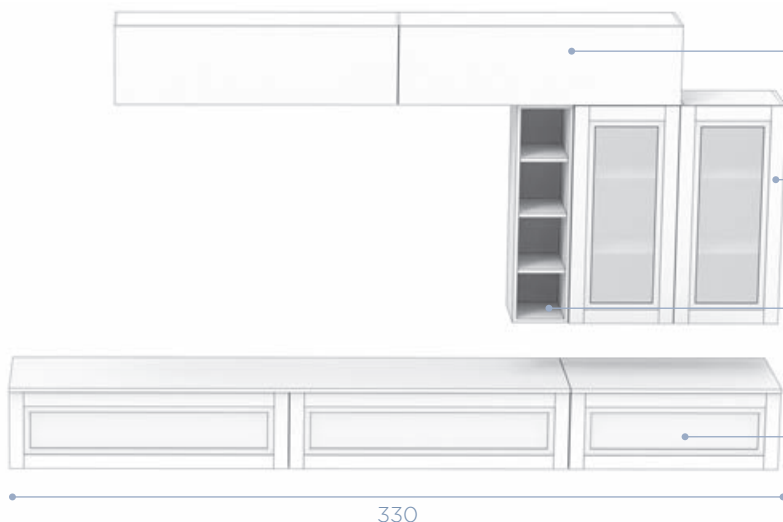

Tablet anta rosso cardinale
(opt.8123)
Tablet cardinal red door
(opt.8123)



Smart anta metal dark
(opt.2309)
Smart dark metal door
(opt.2309)



elemento a giorno laccato
grigio lava opaco (opt.95F1)
matt lava gray lacquered
open element (opt.95F1)

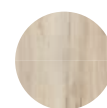

Smart anta betulla
(opt.2311)
Smart birch door
(opt.2311)



smart. □



10

CUCINA LIBERA DAGLI SCHEMI CON I VARI BLOCCHI STACCATI TRA LORO PER OFFRIRE UNA GRANDE FLESSIBILITÀ PROGETTUALE. LA DISPENSA A COLONNE ACCOGLIE GLI ELETTRODOMESTICI, MENTRE L'ARMADIO CON ANTE A VETRO ARRICCHISCE GLI SPAZI CONTENITIVI. LEGGERA LA ZONA OPERATIVA DEL LAVABO CON PARETE ATTREZZATA HI-TECH. COMPLETANO L'ISOLA MULTIFUNZIONALE: PIANO DI LAVORO, BLOCCO COTTURA, ED IL NUOVO ACCESSORIO "MODULAR" IN VERSIONE ISOLA.

AN UNCONVENTIONAL KITCHEN, FEATURING DIFFERENT BLOCKS SEPARATED FROM EACH OTHER, IN ORDER TO OFFER GREATER DESIGN FLEXIBILITY. THE COLUMN PANTRY CONTAINS THE APPLIANCES, WHILE THE GLASS-DOOR CABINET ENRICHES THE STORAGE SPACES. THE WASHBASIN WORKING AREA, WITH ITS HI-TECH EQUIPPED WALL, APPEARS LIGHT. THE COUNTERTOP, THE COOKING BLOCK, AND THE NEW "MODULAR" ACCESSORY IN ISLAND VERSION COMPLETE THE MULTIFUNCTIONAL ISLAND.







Blocco operativo funzionale, pratico l'accessorio sottopensile "Grid" per ospitare attrezzi e utensili a piacimento.

Elegante e polifunzionale l'isola con piano cottura.

Functional operating unit, with the "Grid" under-cabinet accessory to house tools and utensils at will.

The island with hob is refined and multifunctional.



Scheda Tecnica / Technical Area



Koros top H1,2
secret marble
(opt.KS13)
Koros top H1,2
secret marble
(opt.KS13)



Smart anta PET
carbone supermatt
(opt.9613)
Smart supermatt
charcoal PET door
(opt.9613)



Smart anta rovere greige
(opt.2320)
Smart greige oak door
(opt.2320)



Smart anta vetro
PET carbone
(opt.9613)
Smart charcoal
PET glass door
(opt.9613)

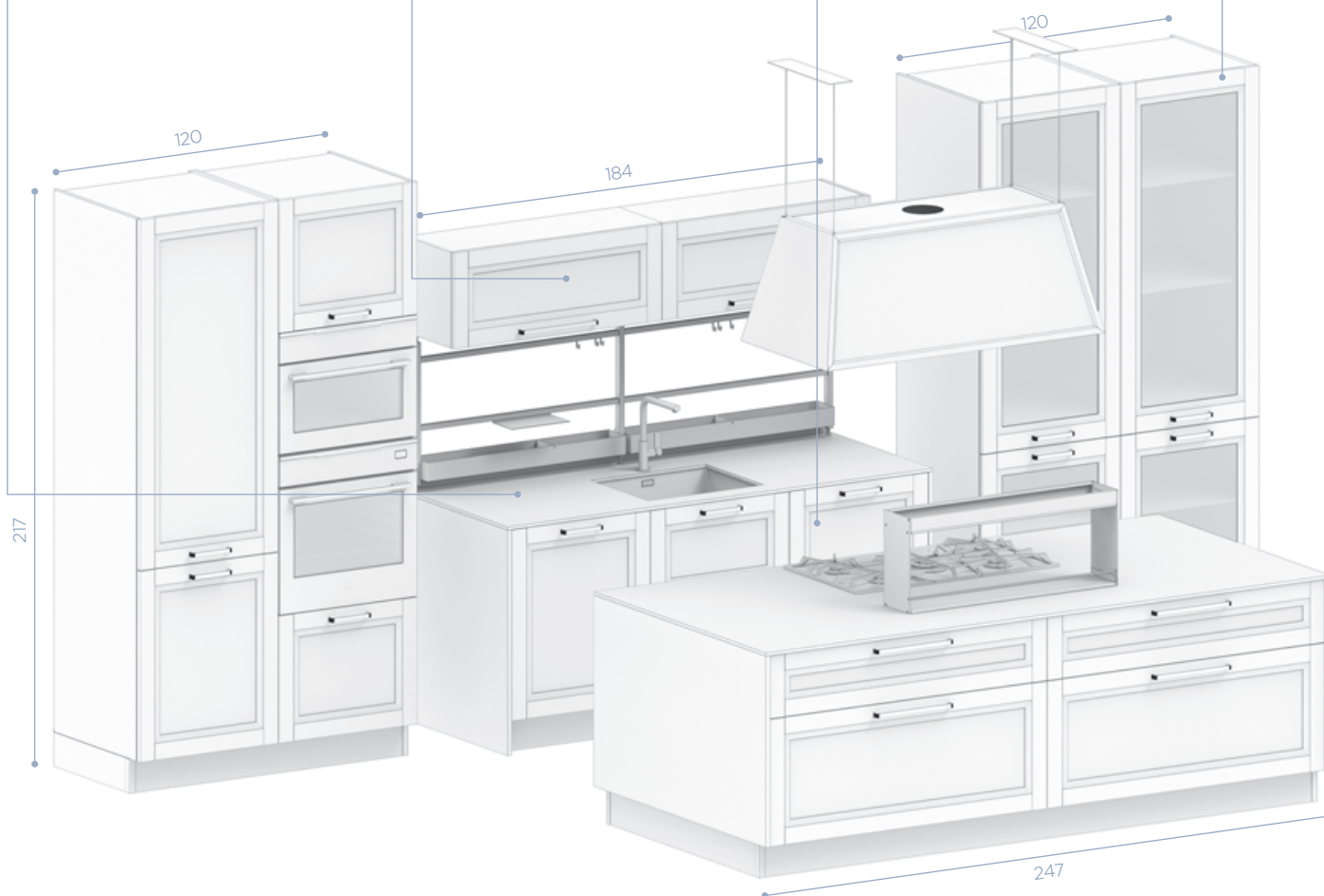

ZOCCOLO - PLINTH



H13 - alluminio finitura silver dark (opt.9507)
H13 - aluminum silver dark finish (opt.9507)

MANIGLIA - HANDLE



K94 - finitura silver dark
K94 - silver dark finish

CAPPA - HOOD

isola K - design - mod.Metis
L.120 - finitura rame
isola K - design - mod.Metis
L.120 - copper finish



Terminale colonna a vetro con vano a giorno.

Column glass end unit with open compartments.



Anta a vetro nella nuova finitura Alkorcell effetto metallo spazzolato.

Glass door in the new brushed metal effect Alkorcell finish.



Nuovo sistema d'arredo "Multiplo" proposto come completamento del fianco colonna.

New "Multiplo" furnishing system proposed as a completion of the column side.



Accessorio “Multiplo” in versione parete con struttura portante metallica e luce integrata.

Wall-mounted “Multiple” accessory with bright metal and dimmable supporting structure.



Nuovo modulo in appoggio su base angolo con apertura “Winch”.

New module mounted on corner base with “Winch” opening.

ANTE - DOOR

ANTE FINITURA ALKORCELL / ALKORCELL FINISH DOORS



frassino bianco alpino (opz.2310)
alpine white ash (opt.2310)



betulla (opz.2311)
birch (opt.2311)



rovere greige (opz.2320)
greige oak (opt.2320)

ANTE VETRO FINITURA ALKORCELL, FINITURA SPAZZOLATA CON VETRO
EXTRACHIARO SERIGRAFATO, TRAMA TESSUTO IN VERNICE SATINATA
GLASS DOORS WITH ALKORCELL FINISH, BRUSHED FINISH WITH SCREEN-
PRINTED EXTRA-CLEAR GLASS, FABRIC TEXTURE IN SATIN PAINT



metal lux (opz.2300)
lux metal (opt.2300)



metal dark (opz.2309)
dark metal (opt.2309)

ANTE - DOOR

ANTE FINITURA PET OPACO TINTA UNITA / SOLID COLOR MATT PET DOOR FINISHES



gesso supermatt (opz.7464)
supermatt plaster (opz.7464)

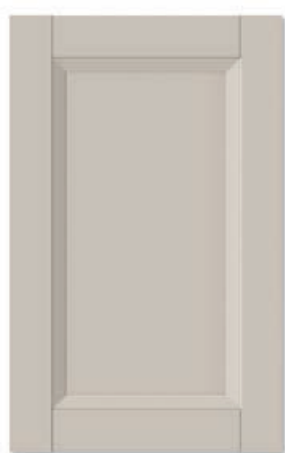

sahara supermatt (opz.7717)
supermatt sahara (opt.7717)

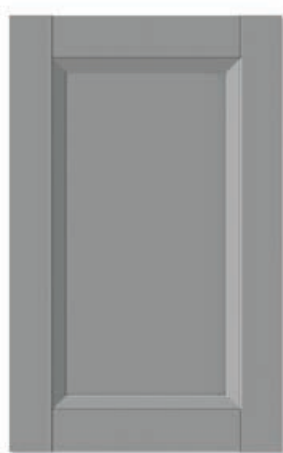

luna supermatt (opz.9610)
supermatt moon (opt.9610)



carbone supermatt (opz.9613)
supermatt coal (opt.9613)

ANTE VETRO FINITURA PET OPACO, VETRO EXTRACHIARO SERIGRAFATO,
TRAMA TESSUTO IN VERNICE SATINATA

MATT PET GLASS DOOR FINISHES, EXTRA-CLEAR SCREEN-PRINTED GLASS,
FABRIC TEXTURE IN SATIN PAINT

*** FINITURE NON DISPONIBILI**



gesso supermatt (opz.7464)
supermatt plaster (opz.7464)



sahara supermatt (opz.7717)
supermatt sahara (opt.7717)



luna supermatt (opz.9610)
supermatt moon (opt.9610)



carbone supermatt (opz.9613)
supermatt coal (opt.9613)

AVANGUARDIA TECNOLOGICA CUTTING-EDGE TECHNOLOGY

La Ditta BLUM fornisce eccellenti sistemi estraibili e di ammortizzamento dei cassetti e delle ante, inseriti di serie in tutti i modelli Creo Kitchens. In Blum tutto gira intorno al movimento, l'obiettivo è la soddisfazione duratura dei clienti Creo Kitchens, con prodotti che convincono per il funzionamento impeccabile, l'apprezzato design e la lunga durata, standard qualitativi applicati anche ai servizi.

BLUM provides excellent pull-out and soft-closing door and drawer systems. These are fitted as standard on all Creo Kitchens models. At Blum everything revolves around movement, the aim is to provide Creo Kitchens customers with long-lasting satisfaction. This is achieved through products with impeccable functionality, good design and long life, quality standards that are also applied to our services.

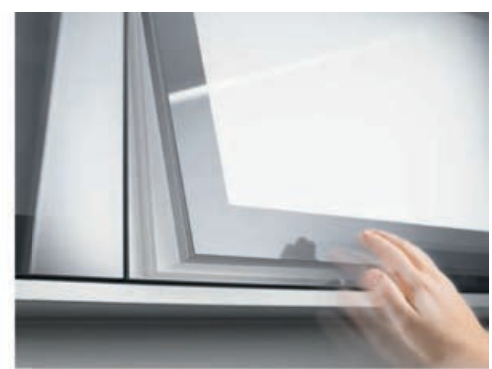

I campioni e i colori riprodotti sono puramente indicativi, la rappresentazione in stampa può alterare la tonalità dei colori, le misure sono di massima, per qualsiasi riferimento vedi listino prezzi.

Lube Industries srl è dotata di Sistemi di Gestione per l'Efficienza Ambientale, per la Qualità e per la Salute e la Sicurezza sul Lavoro, in conformità alle norme: UNI EN ISO 14001, UNI EN ISO 9001 e UNI EN ISO 45001.
Per maggiori informazioni visita il nostro sito www.creokitchens.it

The samples and colours reproduced here are purely indicative as their representation in print can change the shades of the colours. Measurements are approximate, see the pricelist for all references.

*Lube Industries srl has adopted the Management Systems for Environmental Efficiency, Quality and Health and Safety at Work, in compliance with the regulations: UNI EN ISO 14001, UNI EN ISO 9001 and UNI EN ISO 45001.
For more information, visit our website www.creokitchens.it*